

DUAL VOLTAGE TRACKING REGULATOR

DESCRIPTION

This circuit is a dual polarity tracking regulator designed to provide balanced positive and negative output voltages at currents up to 100mA. It is internally set for positive and negative 15 volt outputs but a single external adjustment can be used to change both outputs simultaneously from 10 to 23 volts. This device can be used with input voltages of up to ± 35 volts and also has provision for adjustable current limiting, and utilization at currents in excess of two amps with the aid of external power transistors. A built-in sensing circuit monitors junction temperature and shuts down the regulator above 170°C eliminating the user's need for concern about power dissipation under short circuit conditions. The SG1501A will operate over the military ambient temperature range of -55°C to 125°C, while the SG2501A, SG3501A, and SG4501 are designed for commercial applications of 0°C to 70°C.

FEATURES

- ± 15 V tracking outputs
- Output currents to 100mA
- Internal thermal shutdown protection
- Precision line and load regulation
- 1% maximum temperature variation
- Adjustable current limit
- ± 35 V inputs
- Output adjustable from ± 10 V to ± 23 V

HIGH RELIABILITY FEATURES - SG1501A

- ◆ Available to MIL-STD-883
- ◆ SG level "S" processing available

4

BLOCK DIAGRAM

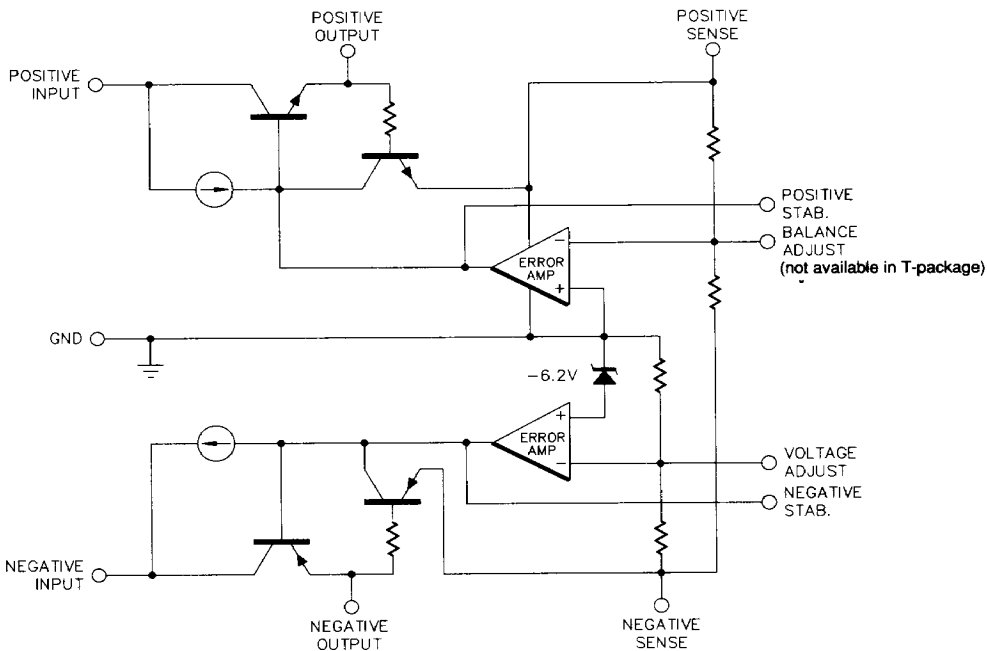

SG1501A/SG2501A/SG3501A/SG4501

ABSOLUTE MAXIMUM RATINGS (Note 1)

Input Voltage from V+ to V-
 SG1501A, SG2501A 70V
 SG3501A, SG4501 60V
 Maximum Load Current 100mA

Operating Junction Temperature
 Hermetic (J, T, L - Packages) 150°C
 Plastic (N - Packages) 150°C
 Storage Temperature Range -65°C to 150°C
 Lead Temperature (Soldering, 10 Seconds) 300°C

Note 1. Exceeding these ratings could cause damage to the device.

THERMAL DERATING CURVES

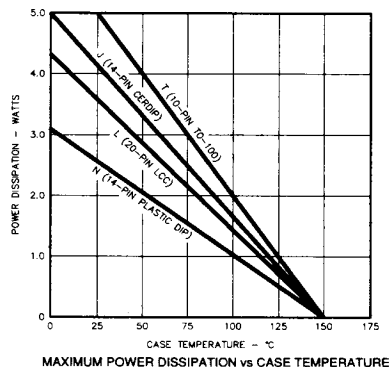
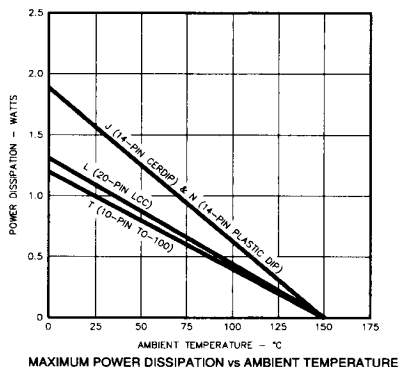

RECOMMENDED OPERATING CONDITIONS (Note 2)

Input Voltage from V+ to V-
 SG1501A, SG2501A 60V
 SG3501A, 4501 50V
 Output Current 0 to 50mA

Input - Output Differential (minimum) 4V
 Operating Ambient Temperature Range (T_J)
 SG1501A -55°C to 125°C
 SG2501A, SG3501A, SG4501 0°C to 70°C

Note 2. Range over which the device is functional.

ELECTRICAL SPECIFICATIONS

(Unless otherwise stated, these specifications apply for the operating ambient temperature of T_A = 25°C, V_{IN} = ±20V, V_{OUT} = ±15V, I_L = 0, R_{SC} = 0Ω, C₁ = C₂ = 0.01μF, C₃ = C₄ = 1.0μF, and VOLTAGE ADJUSTMENT pin open. All specifications apply to both positive and negative sides of the regulator, either singly or together. Low duty cycle pulse testing techniques are used which maintains junction and case temperatures equal to the ambient temperature.)

| Parameter | Test Conditions | SG1501A/2501A | | | SG3501A | | | SG4501 | | | Units |
|------------------------------------|--|---------------|------|------|---------|------|------|--------|------|-------|-------------------|
| | | Min. | Typ. | Max. | Min. | Typ. | Max. | Min. | Typ. | Max. | |
| Output Voltage | | 14.8 | 15 | 15.2 | 14.5 | 15 | 15.5 | 14.25 | | 15.75 | V |
| Input Voltage | | | | ±35 | | | ±30 | | | ±30 | V |
| Input - Output Differential | R _{SC} = 0, I _L = 50mA | 2 | | | 2 | | | 2 | | | V |
| Output Voltage Balance | | | 50 | 150 | | 50 | 300 | | 50 | 300 | mV |
| Line Regulation | V _{IN} = 17V to V _{MAX} , T _A = T _{MIN} to T _{MAX} | | 4 | 20 | | 4 | 20 | | 4 | 20 | mV |
| Load Regulation | I _L = 0mA to 50mA, T _A = T _{MIN} to T _{MAX} | | 5 | 30 | | 5 | 30 | | 5 | 30 | mV |
| Output Voltage Range | Voltage adjust circuit | 10 | | 23 | 10 | | 23 | 10 | | 23 | V |
| Input Voltage Range | 10V Output | 12 | | 35 | 12 | | 30 | 12 | | 30 | V |
| Ripple Rejection | f = 120Hz | | 75 | | | 75 | | | 75 | | dB |
| Temperature Stability (Note 3) | T _A = T _{MIN} to T _{MAX} | | 0.3 | 1.0 | | 0.3 | 1.0 | | 0.3 | 1.0 | % |
| Short Circuit Current Limit | R _{SC} = 10Ω | | 60 | | | 60 | | | 60 | | mA |
| Output Noise Voltage | BW = 100Hz to 10KHz | | 50 | | | 50 | | | 50 | | μV _{rms} |
| Positive Standby Current | I _L = 0 | | 2 | 4 | | 2 | 4 | | 2 | 4 | mA |
| Negative Standby Current | I _L = 0 | | 3 | 5 | | 3 | 5 | | 3 | 5 | mA |
| Long Term Stability | | | 0.1 | | | 0.1 | | | 0.1 | | %/Khr |

Note 3. These parameters, although guaranteed, are not tested in production.

CHARACTERISTIC CURVES

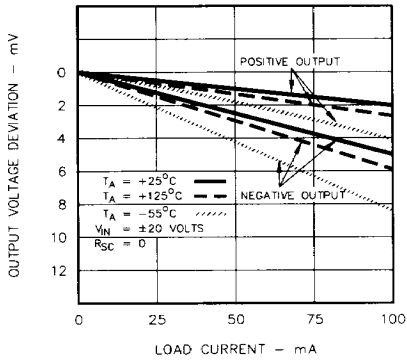

FIGURE 1. LOAD REGULATION

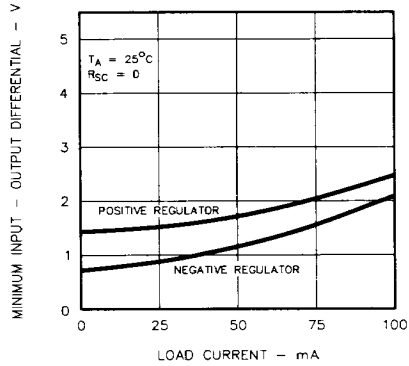

FIGURE 2. REGULATOR DROPOUT VOLTAGE

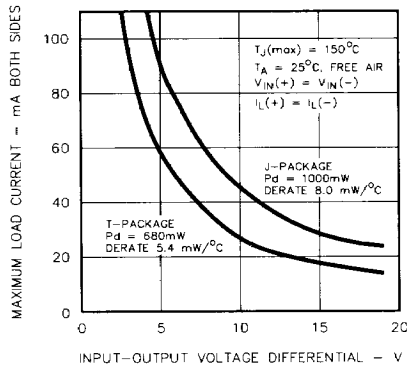

FIGURE 3. MAXIMUM CURRENT CAPABILITY

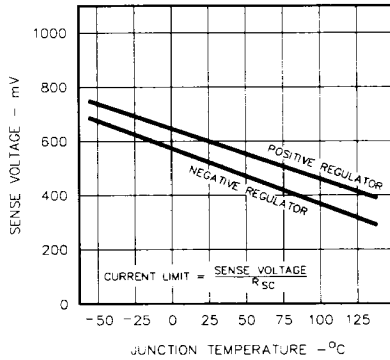

FIGURE 4. CURRENT LIMITING CHARACTERISTICS

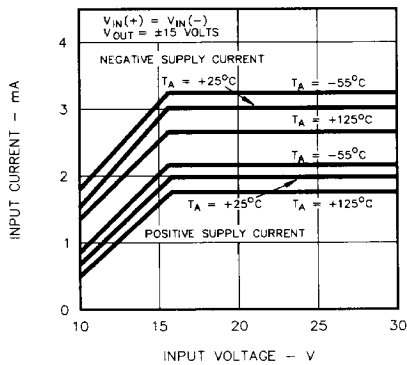

FIGURE 5. STANDBY CURRENT DRAIN

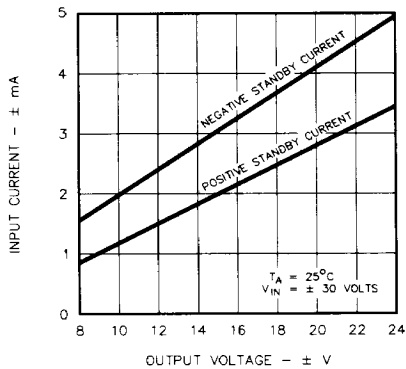

FIGURE 6. STANDBY CURRENT DRAIN

CHARACTERISTIC CURVES

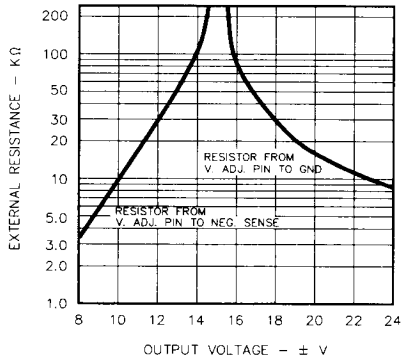

FIGURE 7. EXTERNAL PARALLEL RESISTOR REQUIRED FOR VOLTAGES OTHER THAN ± 15 VOLTS

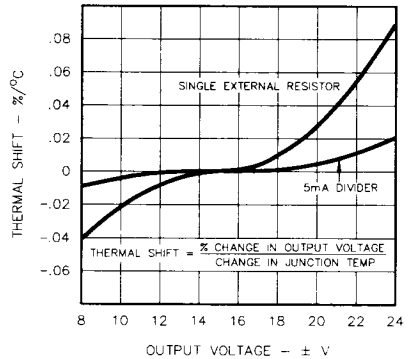

FIGURE 8. TEMPERATURE COEFFICIENT OF OUTPUT VOLTAGE

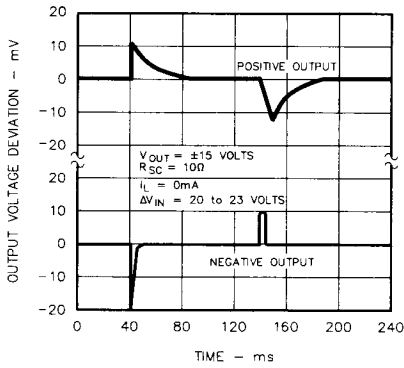

FIGURE 9. LINE TRANSIENT RESPONSE

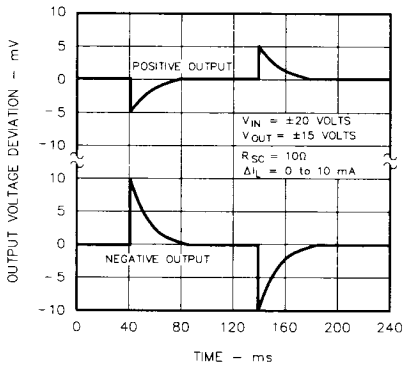

FIGURE 10. LOAD TRANSIENT RESPONSE

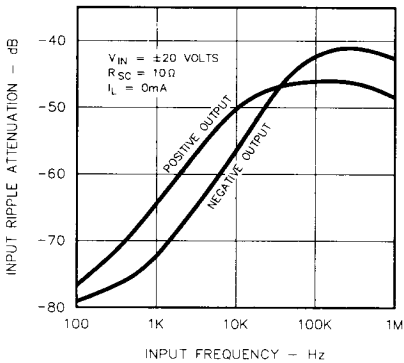

FIGURE 11. RIPPLE REJECTION

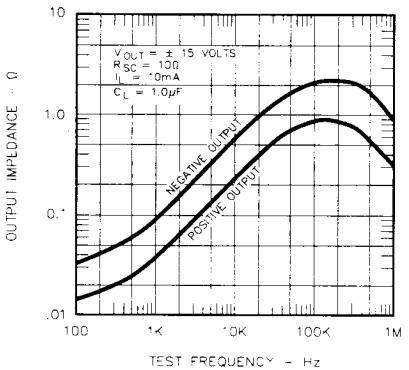

FIGURE 12. OUTPUT IMPEDANCE

TYPICAL APPLICATIONS

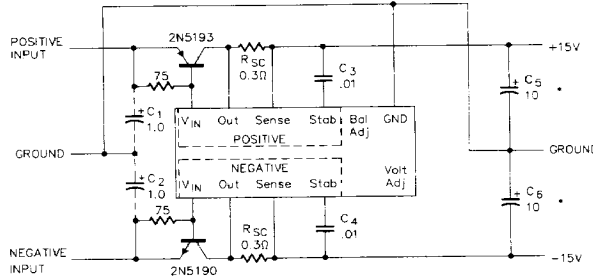

FIGURE 13 - HIGH CURRENT CONFIGURATION, ONE AMP OUTPUT

For full power output, the external transistors must be mounted on adequate heat sinks. Selection of power transistors may be made on the basis of current and voltage capability with low-frequency devices preferred to minimize the risk of oscillation. In this circuit, the value of R_{SC} is selected in order to protect the pass transistors rather than the IC. C_1 and C_2 are only necessary if high line impedance is present.

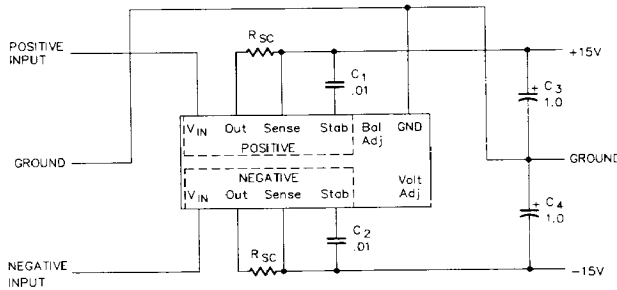

FIGURE 14 - BASIC ±15 V, 50mA REGULATOR

Additional reduction in output noise voltage may be achieved with larger values for C_1 and C_2 although there is some loss in frequency response. C_3 and C_4 may also be increased to improve load transient characteristics. Note that the case is common to $-V_{IN}$, not ground.

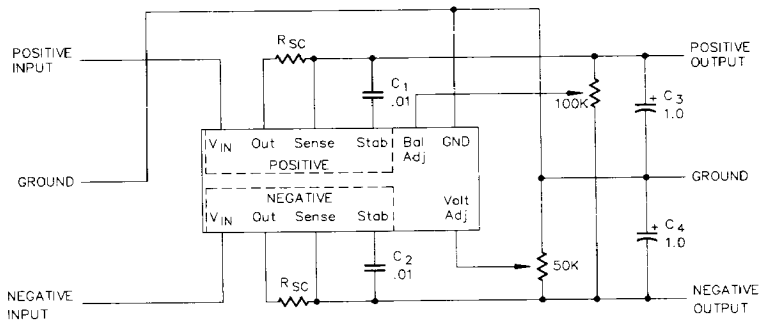

FIGURE 15 - ADJUSTMENT OF VOLTAGE LEVELS

Greater resolution may be achieved by padding each of the potentiometer with fixed resistors. Also, a single resistor, rather than a divider, may be used when adjustment in only one direction is required, but some degradation in temperature coefficient results (see temperature coefficient of output voltage curve).

4

SG1501A/SG2501A/SG3501A/SG4501

APPLICATION NOTE

Although the SG1501A series contains thermal limiting circuitry, the maximum current must still be controlled to allow time for this protection to react. Therefore, without external pass transistors, the minimum value for R_{sc} is three ohms. R_{sc} can, of course, have a larger value in order to protect a load.

the negative side when the device goes into current limiting. Should this be a problem, it may be eliminated by by-passing R_{sc} with a capacitor whose value is such that the time constant, $R_{sc} C$, is equal to 10×10^{-6} second. This capacitor, as well as the output capacitors, C3 and C4, must be low ESR types such as solid tantalum.

Under some conditions, a low-level oscillation may be present on

CONNECTION DIAGRAMS & ORDERING INFORMATION (See Note Below)

| Package | Part No. | Ambient Temperature Range | Connection Diagram |
|--|--|---|--------------------|
| 14-PIN CERAMIC DIP J - PACKAGE | SG1501AJ/883B SG1501AJ SG2501AJ SG3501AJ SG4501T | -55°C to 125°C -55°C to 125°C 0°C to 70°C 0°C to 70°C 0°C to 70°C | |
| 14-PIN PLASTIC DIP N - PACKAGE | SG2501AN SG3501AN SG4501N | 0°C to 70°C 0°C to 70°C 0°C to 70°C | |
| 10-PIN TO-100 METAL CAN T-PACKAGE | SG1501AT/883B SG1501AT SG2501AT SG3501AT SG4501T | -55°C to 125°C -55°C to 125°C 0°C to 70°C 0°C to 70°C 0°C to 70°C | |
| 20-PIN CERAMIC LEADLESS CHIP CARRIER L - PACKAGE | SG1501AL/883B SG1501AL | -55°C to 125°C -55°C to 125°C | <p>(Note 3)</p> |

Note 1. All packages are viewed from the top.

Note 2. The Balance Adjust function is not available in the "T" package.

Note 3. The Negative Input (V-) pin is internally connected to the case.

Silicon General • 11861 Western Avenue • Garden Grove, CA 92641 • (714) 898-8121 • TWX: 910-596-1804 • FAX: (714) 893-2570