

## Precision Metal Film Resistors

### FEATURES

- 0.063 W to 0.5 W at 70 °C
- According to CECC 40101
- Wide ohmic range from 1 Ω to 4.7 MΩ
- Good initial precision up to ± 0.1 %
- Operating temperatures:
  - 55 °C to + 155 °C for TCR ≥ 25 ppm/°C
  - 25 °C to + 85 °C for TCR ≤ 15 ppm/°C
- Epoxy coating
- Termination: Pure matt tin
- Material categorization: For definitions of compliance please see [www.vishay.com/doc?99912](http://www.vishay.com/doc?99912)

**RoHS**  
COMPLIANT

DIMENSIONS in millimeters							
	TYPE	Ø D max.	L max.	A ± 1	Ø d	CC <sub>e</sub>	WEIGHT in g
	N.. 3..	1.8	3.9	53	0.5	5.08	0.15
	N.. 4..	2.5	6.2	53	0.6	NA	0.3
	N.. 5..	3.3	8.7	53	0.6	NA	0.5

STANDARD ELECTRICAL SPECIFICATIONS					
MODEL	RESISTANCE RANGE Ω	RATED POWER P <sub>70 °C</sub> W	LIMITING ELEMENT VOLTAGE V	TOLERANCE ± %	TEMPERATURE COEFFICIENT ± ppm/°C
NT3S	10 to 200K	0.125	200	0.1, 0.25, 0.5, 1	15
NP3S	10 to 511K	0.250	200	0.1, 0.25, 0.5, 1	25
NY3	1 to 1.5M	0.250	200	0.5, 1	50
NK3	1 to 1.5M	0.250	200	2, 5	100
NT4S	10 to 499K	0.250	350	0.1, 0.25, 0.5, 1	15
NP4S	10 to 1M	0.500	350	0.1, 0.25, 0.5, 1	25
NY4	10 to 3.32M	0.500	350	0.1, 0.25, 0.5, 1	50
NK4	10 to 3.3M	0.500	350	2, 5	100
NT5S	10 to 499K	0.500	350	0.1, 0.25, 0.5, 1	15
NP5S	10 to 1M	0.500	350	0.1, 0.25, 0.5, 1	25
NY5	2.67 to 4.7M	0.500	350	0.1, 0.25, 0.5, 1	50
NK5	2.7 to 4.M	0.500	350	2, 5	100



TECHNICAL SPECIFICATIONS														
MODEL	NT3S	NP3S	NY3	NK3	NT4S	NP4S	NY4	NK4	NT5S	NP5S	NY5	NK5		
Power Rating, $P_r$ at + 70 °C	0.125 W	0.25 W			0.25 W	0.5 W			0.5 W					
Stability Class	1 %			2 %	1 %			2 %	1 %			2 %		
Preferred Standard Ohmic Values Series	E192 for 0.1 %/0.25 %/0.5 % E96 for 1 %			E24	E192 for 0.1 %/0.25 %/0.5 % E96 for 1 %			E24	E192 for 0.1 %/0.25 %/0.5 % E96 for 1 %			E24		
Ohmic Value Range in Relation to: Temperature Coefficient, TCR/ Tolerance	± 15 ppm/°C <sup>(1)</sup>	± 0.1 %	100 Ω	-	-	-	49.9 Ω	-	-	-	100 Ω	-	-	
		± 0.25 %	200 kΩ	-	-	-	499 kΩ	-	-	-	499 kΩ	-	-	
		± 0.5 %	10 Ω	-	-	-	10 Ω	-	-	-	10 Ω	-	-	
		± 1 %	200 kΩ	-	-	-	499 kΩ	-	-	-	499 kΩ	-	-	
	± 25 ppm/°C <sup>(2)</sup>	± 0.1 %	-	100 Ω	-	-	-	10 Ω	-	-	-	100 Ω	-	-
		± 0.25 %	-	511 kΩ	-	-	-	1 MΩ	-	-	-	1 MΩ	-	-
		± 0.5 %	-	10 Ω	-	-	-	10 Ω	-	-	-	10 Ω	-	-
		± 1 %	-	511 kΩ	-	-	-	1 MΩ	-	-	-	1 MΩ	-	-
	± 50 ppm/°C <sup>(2)</sup>	± 0.1 %	-	-	-	-	-	-	10 Ω	-	-	-	10 Ω	-
		± 0.25 %	-	-	-	-	-	-	1 MΩ	-	-	-	1 MΩ	-
		± 0.5 %	-	-	10 Ω	-	-	-	10 Ω	-	-	-	10 Ω	-
					1.5 MΩ	-	-	-	3.32 MΩ	-	-	-	4.7 MΩ	-
	± 100 ppm/°C <sup>(2)</sup>	± 1 %	-	-	1 Ω	-	-	-	10 Ω	-	-	-	2.67 Ω	-
					1.5 MΩ	-	-	-	3.32 MΩ	-	-	-	4.7 MΩ	-
Limiting Element Voltage $U_{max. RMS}$	200 V				350 V				350 V					
Critical Resistance	-	-	160 kΩ	490 kΩ	245 kΩ			245 kΩ						
Thermal Resistance	170 °C/W				145 °C/W				110 °C/W					

**Notes**

- (1) TCR requirement for temperature between - 25 °C and + 85 °C
- (2) TCR requirement for temperature between - 55 °C and + 125 °C

ENVIRONMENTAL SPECIFICATIONS												
MODEL	NT3S	NP3S	NY3	NK3	NT4S	NP4S	NY4	NK4	NT5S	NP5S	NY5	NK5
Temperature Range	- 25 °C to + 85 °C	- 55 °C to + 155 °C			- 25 °C to + 85 °C	- 55 °C to + 155 °C			- 25 °C to + 85 °C	- 55 °C to + 155 °C		
Climatic Category (LCT/UCT/days)	-	55/125/56			-	55/125/56			-	55/125/56		



PERFORMANCE					
TEST		CONDITIONS	REQUIREMENTS		TYPICAL DRIFT
			STABILITY CLASS 1 CECC 40101-002/803	STABILITY CLASS 2 CECC 40101-001/802	
Short Time Overload		IEC 60115-1 6.25 $P_T$ or 2 $U_{max}$ , 1 s for 0.063 W/5 s for $\geq 0.125$ W	$\pm (0.25 \% + 0.05 \Omega)$	$\pm (0.5 \% + 0.05 \Omega)$	$\leq \pm 0.05 \%$
Load Life		IEC 60115-1 90'/30' cycles, 1000 h at $P_T/70$ °C	$\pm (1 \% + 0.05 \Omega)$	$\pm (2 \% + 0.1 \Omega)$	$\leq \pm 0.25 \%$
Load Life at Maximum Category Temperature		IEC 60115-1 90'/30' cycles, 1000 h at derated $P_T/125$ °C	$\pm (1 \% + 0.05 \Omega)$	$\pm (2 \% + 0.1 \Omega)$	$\leq \pm 0.25 \%$
		IEC 60115-1 1000 h at 155 °C	-	-	
Sheft Life		1 year at ambient temperature	-	-	$\leq \pm 0.1 \%$
Seq. A1	Robustness of Terminations	IEC 60115-1, IEC 60068-2-21 Test Ua1: Traction 10 N/10 s Test Ub: Bending + 90° → - 90° → 0° with 5 N Test Uc: Twisting 2 times at 180°	$\pm (0.25 \% + 0.05 \Omega)$	$\pm (0.5 \% + 0.05 \Omega)$	$\leq \pm 0.1 \%$
Seq. A2	Resistance to Soldering Heat	IEC 60115-1 IEC 60068-2-20 Test Tb Method 1: Solder bath 260 °C/10 s	$\pm (0.25 \% + 0.05 \Omega)$	$\pm (0.5 \% + 0.05 \Omega)$	$\leq \pm 0.05 \%$
Seq. B1	Rapid Change of Temperature	IEC 60115-1, IEC 60068-2-14 Test Na 5 cycles (30' at LCT/30' at UCT), - 55 °C/125 °C	$\pm (0.25 \% + 0.05 \Omega)$	$\pm (0.5 \% + 0.05 \Omega)$	$\leq \pm 0.05 \%$
Seq. B2	Vibration	IEC 60115-1, IEC 60068-2-6 Test Fc 10 Hz/500 Hz	$\pm (0.25 \% + 0.05 \Omega)$	$\pm (0.5 \% + 0.05 \Omega)$	$\leq \pm 0.1 \%$
Seq. A + B	Climatic Sequence	IEC 60115-1 1. Dry heat at 125 °C/16 h (IEC 60068-2-2) 2. Damp heat 55 °C/24 h (IEC 60068-2-30 Test Db) 3. Cold at - 55 °C/2 h (IEC 60068-2-1 Test Aa) 4. Low pressure 25 °C/1 h (IEC 60068-2-13) 5. Damp heat 55 °C/120 h (IEC 60068-2-30 Test Db)	$\pm (1 \% + 0.05 \Omega)$	$\pm (2 \% + 0.1 \Omega)$	$\leq \pm 0.25 \%$
Damp Heat, Steady State		IEC 60115-1, IEC 60068-2-78 40 °C/93 % RH/56 days	$\pm (1 \% + 0.05 \Omega)$	$\pm (2 \% + 0.1 \Omega)$	$\leq \pm 0.5 \%$



**POWER RATING CHARTS**

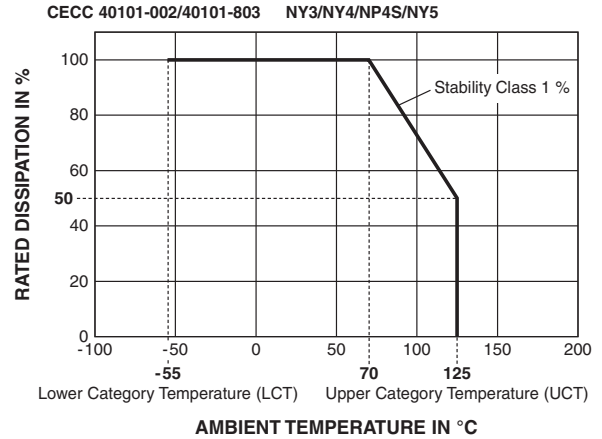
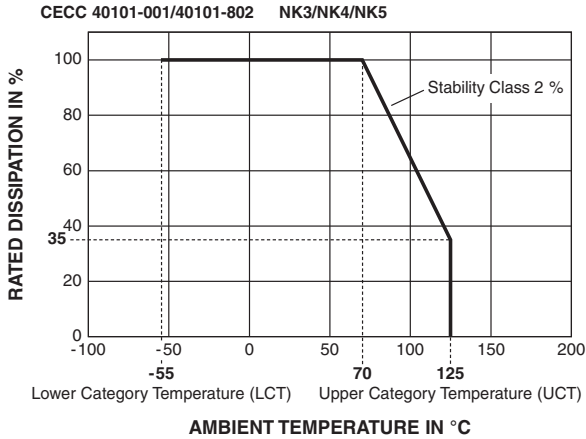

**HIGH FREQUENCY**

Typical behavior for NK4

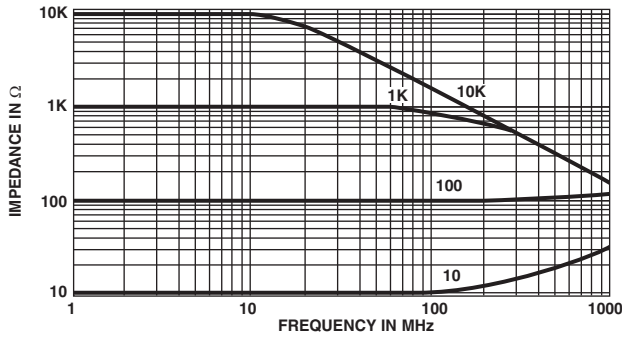

**THIRD HARMONIC**

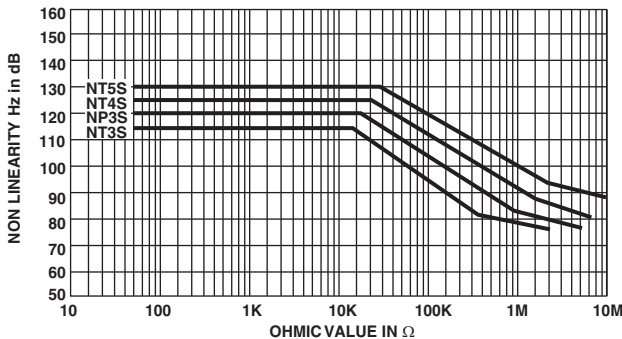

**NOISE**

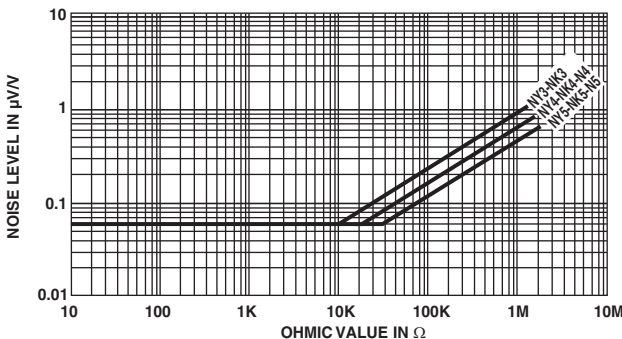

**MARKING**

Resistor color code chart 6, 5, or 4 bands.

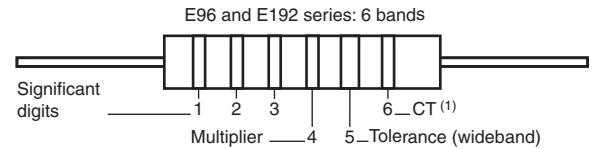

**Note**

(1) Only for TCR ≤ 25 ppm/°C

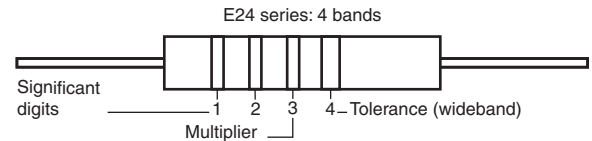

COLOR	DIGIT.	MULTIP.	TOL %	CT ppm/°C
Black	0	1		
Brown	1	10	1	
Red	2	10 <sup>2</sup>	2	
Orange	3	10 <sup>3</sup>		± 15
Yellow	4	10 <sup>4</sup>		± 25
Green	5	10 <sup>5</sup>	0.5	
Blue	6	10 <sup>6</sup>	0.25	± 10
Purple	7	10 <sup>7</sup>	0.1	± 5
Grey	8	10 <sup>8</sup>		
White	9	10 <sup>9</sup>		
Silver		10 <sup>-2</sup>		
Gold		10 <sup>-1</sup>	5	

TAPE IN REEL	
SERIES AND MODEL	QUANTITY PER REEL
NT4S/NP4S	5000
NK4/NY4	5000
SL3	5000
SL4	5000

TAPED IN AMMOPACK		
SERIES AND MODEL	QUANTITY PER BOX	BOX DIMENSIONS L x l x H (mm)
NT3S/NP3S	500	260 x 80 x 26
NY3	500	
NK3/SL3	1000	
NT4S/NP4S	500	
NY4	500	260 x 80 x 37
NK4/SL4	1000	260 x 85 x 28
NT5S/NP5S	500	
NK5	500	

TAPED IN BAG		
SERIES AND MODEL	QUANTITY PER BAG	BOX DIMENSIONS (mm)
NP3S/NT3S	100	85 x 140
NP4S/NT4S		
NP5S/NT5S		
NY3 CC/NK3 CC	500	

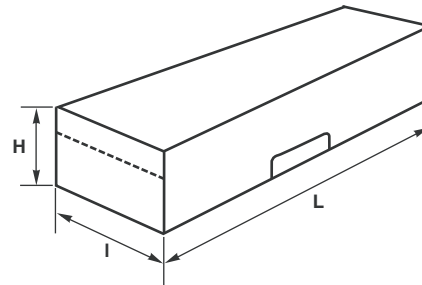
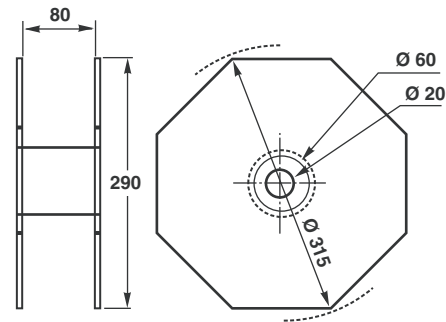
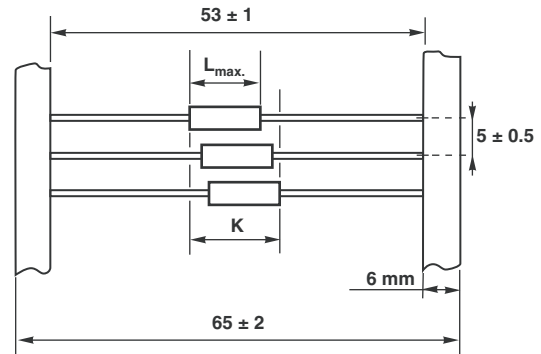
**PACKAGING**

The resistors are required to be inside a window which is the K dimension.

K being equal to the maximum body length of the resistor + 1.4 mm and being centered as per IEC 60286-1 and EIA-296 specification to the tape edges.

ORDERING INFORMATION					
T3	XXX	100 kΩ	1 %	AM1000	e3
MODEL	CUSTOM DESIGN	OHMIC VALUE	TOLERANCE	PACKAGING	LEAD (Pb)-FREE

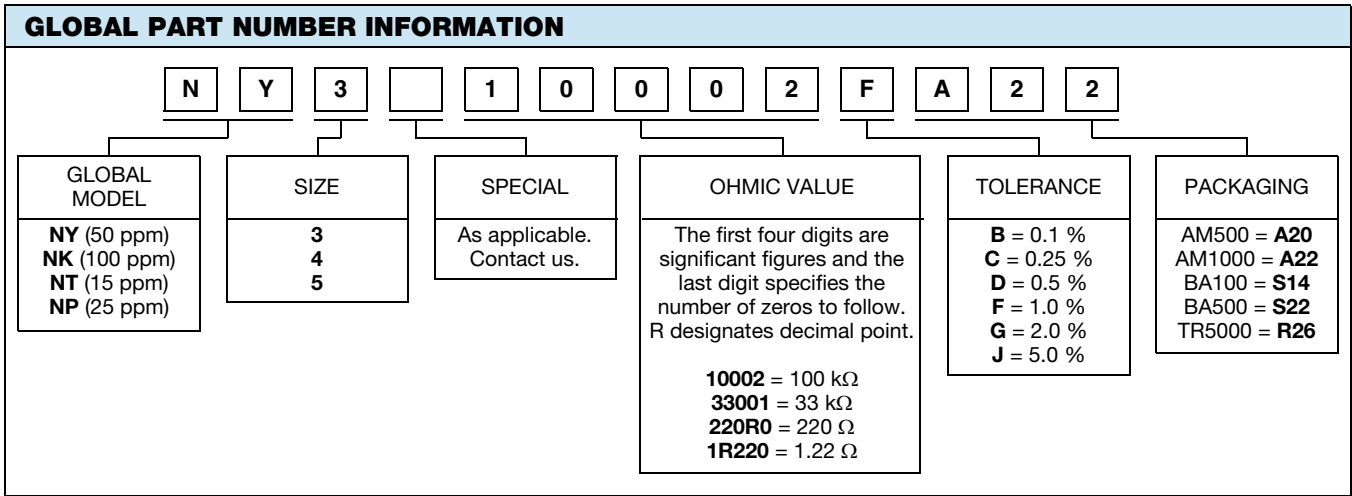



## Disclaimer

ALL PRODUCT, PRODUCT SPECIFICATIONS AND DATA ARE SUBJECT TO CHANGE WITHOUT NOTICE TO IMPROVE RELIABILITY, FUNCTION OR DESIGN OR OTHERWISE.

Vishay Intertechnology, Inc., its affiliates, agents, and employees, and all persons acting on its or their behalf (collectively, "Vishay"), disclaim any and all liability for any errors, inaccuracies or incompleteness contained in any datasheet or in any other disclosure relating to any product.

Vishay makes no warranty, representation or guarantee regarding the suitability of the products for any particular purpose or the continuing production of any product. To the maximum extent permitted by applicable law, Vishay disclaims (i) any and all liability arising out of the application or use of any product, (ii) any and all liability, including without limitation special, consequential or incidental damages, and (iii) any and all implied warranties, including warranties of fitness for particular purpose, non-infringement and merchantability.

Statements regarding the suitability of products for certain types of applications are based on Vishay's knowledge of typical requirements that are often placed on Vishay products in generic applications. Such statements are not binding statements about the suitability of products for a particular application. It is the customer's responsibility to validate that a particular product with the properties described in the product specification is suitable for use in a particular application. Parameters provided in datasheets and/or specifications may vary in different applications and performance may vary over time. All operating parameters, including typical parameters, must be validated for each customer application by the customer's technical experts. Product specifications do not expand or otherwise modify Vishay's terms and conditions of purchase, including but not limited to the warranty expressed therein.

Except as expressly indicated in writing, Vishay products are not designed for use in medical, life-saving, or life-sustaining applications or for any other application in which the failure of the Vishay product could result in personal injury or death. Customers using or selling Vishay products not expressly indicated for use in such applications do so at their own risk. Please contact authorized Vishay personnel to obtain written terms and conditions regarding products designed for such applications.

No license, express or implied, by estoppel or otherwise, to any intellectual property rights is granted by this document or by any conduct of Vishay. Product names and markings noted herein may be trademarks of their respective owners.

## Material Category Policy

**Vishay Intertechnology, Inc. hereby certifies that all its products that are identified as RoHS-Compliant fulfill the definitions and restrictions defined under Directive 2011/65/EU of The European Parliament and of the Council of June 8, 2011 on the restriction of the use of certain hazardous substances in electrical and electronic equipment (EEE) - recast, unless otherwise specified as non-compliant.**

**Please note that some Vishay documentation may still make reference to RoHS Directive 2002/95/EC. We confirm that all the products identified as being compliant to Directive 2002/95/EC conform to Directive 2011/65/EU.**

**Vishay Intertechnology, Inc. hereby certifies that all its products that are identified as Halogen-Free follow Halogen-Free requirements as per JEDEC JS709A standards. Please note that some Vishay documentation may still make reference to the IEC 61249-2-21 definition. We confirm that all the products identified as being compliant to IEC 61249-2-21 conform to JEDEC JS709A standards.**