

MC14060B

14-Bit Binary Counter and Oscillator

The MC14060B is a 14-stage binary ripple counter with an on-chip oscillator buffer. The oscillator configuration allows design of either RC or crystal oscillator circuits. Also included on the chip is a reset function which places all outputs into the zero state and disables the oscillator. A negative transition on Clock will advance the counter to the next state. Schmitt trigger action on the input line permits very slow input rise and fall times. Applications include time delay circuits, counter controls, and frequency dividing circuits.

This device contains protection circuitry to guard against damage due to high static voltages or electric fields. However, precautions must be taken to avoid applications of any voltage higher than maximum rated voltages to this high-impedance circuit. For proper operation, V_{in} and V_{out} should be constrained to the range $V_{SS} \leq (V_{in} \text{ or } V_{out}) \leq V_{DD}$.

Unused inputs must always be tied to an appropriate logic voltage level (e.g., either V_{SS} or V_{DD}). Unused outputs must be left open.

Features

- Fully Static Operation
- Diode Protection on All Inputs
- Supply Voltage Range = 3.0 V to 18 V
- Capable of Driving Two Low-power TTL Loads or One Low-power Schottky TTL Load Over the Rated Temperature Range
- Buffered Outputs Available from Stages 4 Through 10 and 12 Through 14
- Common Reset Line
- Pin-for-Pin Replacement for CD4060B
- Pb-Free Packages are Available*

MAXIMUM RATINGS (Voltages Referenced to V_{SS})

Symbol	Parameter	Value	Unit
V_{DD}	DC Supply Voltage Range	-0.5 to +18.0	V
V_{in} , V_{out}	Input or Output Voltage Range (DC or Transient)	-0.5 to V_{DD} +0.5	V
I_{in} , I_{out}	Input or Output Current (DC or Transient) per Pin	± 10	mA
P_D	Power Dissipation, per Package (Note 1)	500	mW
T_A	Ambient Temperature Range	-55 to +125	$^{\circ}\text{C}$
T_{stg}	Storage Temperature Range	-65 to +150	$^{\circ}\text{C}$
T_L	Lead Temperature (8 Second Soldering)	260	$^{\circ}\text{C}$

Maximum ratings are those values beyond which device damage can occur. Maximum ratings applied to the device are individual stress limit values (not normal operating conditions) and are not valid simultaneously. If these limits are exceeded, device functional operation is not implied, damage may occur and reliability may be affected.

1. Temperature Derating: Plastic "P and D/DW" Packages: -7.0 mW/ $^{\circ}\text{C}$ from 65 $^{\circ}\text{C}$ To 125 $^{\circ}\text{C}$.

*For additional information on our Pb-Free strategy and soldering details, please download the ON Semiconductor Soldering and Mounting Techniques Reference Manual, SOLDERRM/D.



ON Semiconductor®

<http://onsemi.com>

MARKING DIAGRAMS

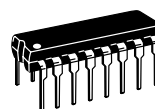

PDIP-16
P SUFFIX
CASE 648

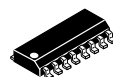
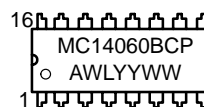

SOIC-16
D SUFFIX
CASE 751B

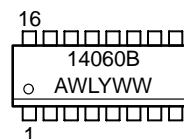

TSSOP-16
DT SUFFIX
CASE 948F

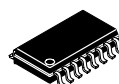
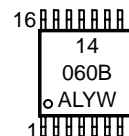

SOEIAJ-16
F SUFFIX
CASE 966

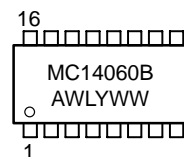

A = Assembly Location
WL, L = Wafer Lot
YY, Y = Year
WW, W = Work Week

ORDERING INFORMATION

See detailed ordering and shipping information in the package dimensions section on page 2 of this data sheet.

MC14060B

ELECTRICAL CHARACTERISTICS (Voltages Referenced to V_{SS})

Symbol	Characteristic	V_{DD} Vdc	- 55°C		25°C			125°C		Unit
			Min	Max	Min	Typ (Note 2)	Max	Min	Max	
V_{OL}	Output Voltage "0" Level $V_{in} = V_{DD}$ or 0	5.0	–	0.05	–	0	0.05	–	0.05	V
		10	–	0.05	–	0	0.05	–	0.05	
		15	–	0.05	–	0	0.05	–	0.05	
V_{OH}	$V_{in} = 0$ or V_{DD} "1" Level	5.0	4.95	–	4.95	5.0	–	4.95	–	V
		10	9.95	–	9.95	10	–	9.95	–	
		15	14.95	–	14.95	15	–	14.95	–	
V_{IL}	Input Voltage "0" Level ($V_O = 4.5$ or 0.5 V) ($V_O = 9.0$ or 1.0 V) ($V_O = 13.5$ or 1.5 V)	5.0	–	1.5	–	2.25	1.5	–	1.5	V
		10	–	3.0	–	4.50	3.0	–	3.0	
		15	–	4.0	–	6.75	4.0	–	4.0	
V_{IH}	($V_O = 0.5$ or 4.5 V) ($V_O = 1.0$ or 9.0 V) ($V_O = 1.5$ or 13.5 V) "1" Level	5.0	3.5	–	3.5	2.75	–	3.5	–	V
		10	7.0	–	7.0	5.50	–	7.0	–	
		15	11.0	–	11.0	8.25	–	11.0	–	
V_{IL}	Input Voltage "0" Level ($V_O = 4.5$ Vdc) ($V_O = 9.0$ Vdc) ($V_O = 13.5$ Vdc) (For Input 11 and Output 10)	5.0	–	1.0	–	2.25	1.0	–	1.0	Vdc
		10	–	2.0	–	4.50	2.0	–	2.0	
		15	–	2.5	–	6.75	2.5	–	2.5	
V_{IH}	($V_O = 0.5$ Vdc) ($V_O = 1.0$ Vdc) ($V_O = 1.5$ Vdc) "1" Level	5.0	4.0	–	4.0	2.75	–	4.0	–	Vdc
		10	8.0	–	8.0	5.50	–	8.0	–	
		15	12.5	–	12.5	8.25	–	12.5	–	
I_{OH}	Output Drive Current ($V_{OH} = 2.5$ V) ($V_{OH} = 4.6$ V) ($V_{OH} = 9.5$ V) ($V_{OH} = 13.5$ V) (Except Source Pins 9 and 10)	5.0	–3.0	–	–2.4	–4.2	–	–1.7	–	mA
		5.0	–0.64	–	–0.51	–0.88	–	–0.36	–	
		10	–1.6	–	–1.3	–2.25	–	–0.9	–	
		15	–4.2	–	–3.4	–8.8	–	–2.4	–	
I_{OL}	Sink ($V_{OL} = 0.4$ V) ($V_{OL} = 0.5$ V) ($V_{OL} = 1.5$ V)	5.0	0.64	–	0.51	0.88	–	0.36	–	mA
		10	1.6	–	1.3	2.25	–	0.9	–	
		15	4.2	–	3.4	8.8	–	2.4	–	
I_{in}	Input Current	15	–	± 0.1	–	± 0.00001	± 0.1	–	± 1.0	μA
C_{in}	Input Capacitance ($V_{in} = 0$)	–	–	–	–	5.0	7.5	–	–	pF
I_{DD}	Quiescent Current (Per Package)	5.0	–	5.0	–	0.005	5.0	–	150	μA
		10	–	10	–	0.010	10	–	300	
		15	–	20	–	0.015	20	–	600	
I_T	Total Supply Current (Notes 3, 4) (Dynamic plus Quiescent, Per Package) ($C_L = 50$ pF on all outputs, all buffers switching)	5.0 10 15	$I_T = (0.25 \mu A/kHz) f + I_{DD}$ $I_T = (0.54 \mu A/kHz) f + I_{DD}$ $I_T = (0.85 \mu A/kHz) f + I_{DD}$							μA

2. Data labelled "Typ" is not to be used for design purposes but is intended as an indication of the IC's potential performance.
3. The formulas given are for the typical characteristics only at 25°C.
4. To calculate total supply current at loads other than 50 pF: $I_T(C_L) = I_T(50 \text{ pF}) + (C_L - 50) Vfk$
where: I_T is in μA (per package), C_L in pF, $V = (V_{DD} - V_{SS})$ in volts, f in kHz is input frequency, and $k = 0.002$.

MC14060B

SWITCHING CHARACTERISTICS (C_L = 50 pF, T_A = 25°C)

Symbol	Characteristic	V _{DD} Vdc	Min	Typ (Note 5)	Max	Unit
t _{TLH}	Output Rise Time (Counter Outputs)	5.0	–	40	200	ns
		10	–	25	100	
		15	–	20	80	
t _{THL}	Output Fall Time (Counter Outputs)	5.0	–	50	200	ns
		10	–	30	100	
		15	–	20	80	
t _{PLH} t _{PHL}	Propagation Delay Time Clock to Q4 Clock to Q14	5.0	–	415	740	ns
		10	–	175	300	
		15	–	125	200	
		5.0	–	1.5	2.7	μs
		10	–	0.7	1.3	
		15	–	0.4	1.0	
t _{WH}	Clock Pulse Width	5.0	100	65	–	ns
		10	40	30	–	
		15	30	20	–	
f _φ	Clock Pulse Frequency	5.0	–	5	3.5	MHz
		10	–	14	8	
		15	–	17	12	
t _{TLH} t _{THL}	Clock Rise and Fall Time	5.0	No Limit			ns
		10				
		15				
t _w	Reset Pulse Width	5.0	120	40	–	ns
		10	60	15	–	
		15	40	10	–	
t _{PHL}	Propagation Delay Time Reset to On	5.0	–	170	350	ns
		10	–	80	160	
		15	–	60	100	

5. Data labelled "Typ" is not to be used for design purposes but is intended as an indication of the IC's potential performance.

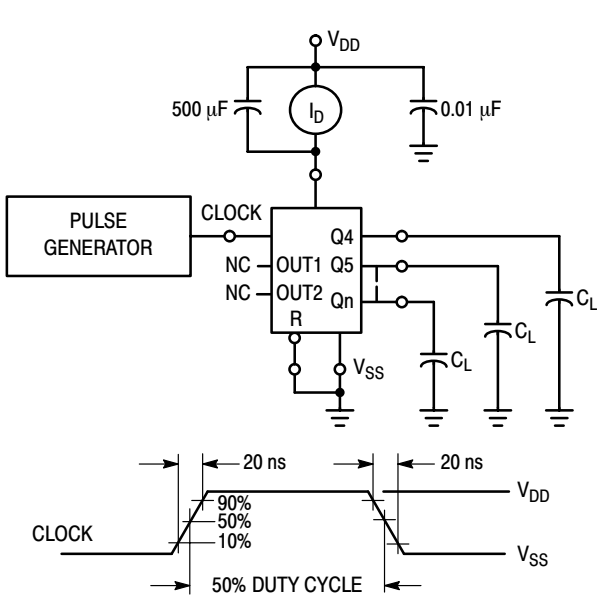

Figure 1. Power Dissipation Test Circuit and Waveform

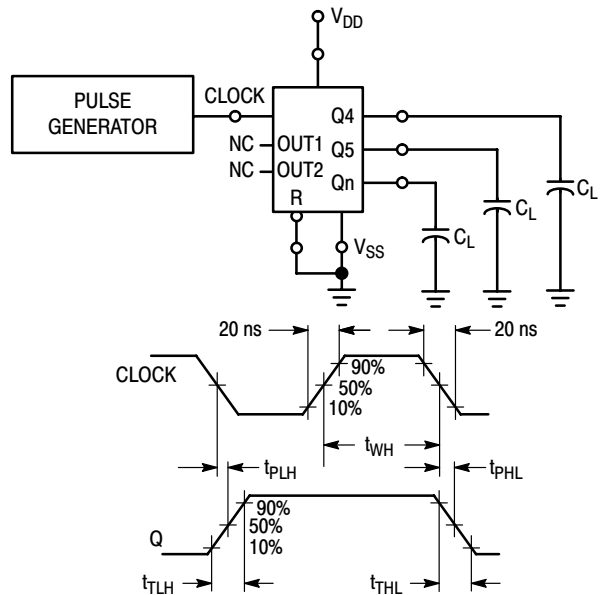
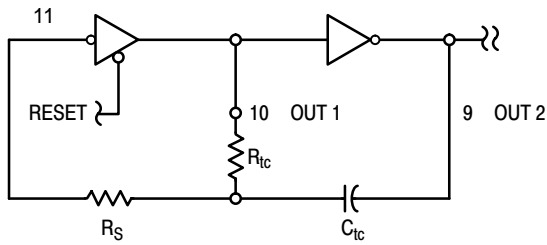

Figure 2. Switching Time Test Circuit and Waveforms

MC14060B



$$f \approx \frac{1}{2.3R_{tc}C_{tc}}$$

if $1 \text{ kHz} \leq f \leq 100 \text{ kHz}$
and $2R_{tc} < R_S < 10R_{tc}$
(f in Hz, R in ohms, C in farads)

The formula may vary for other frequencies. Recommended maximum value for the resistors in $1 \text{ M}\Omega$.

Figure 3. Oscillator Circuit Using RC Configuration

TYPICAL RC OSCILLATOR CHARACTERISTICS

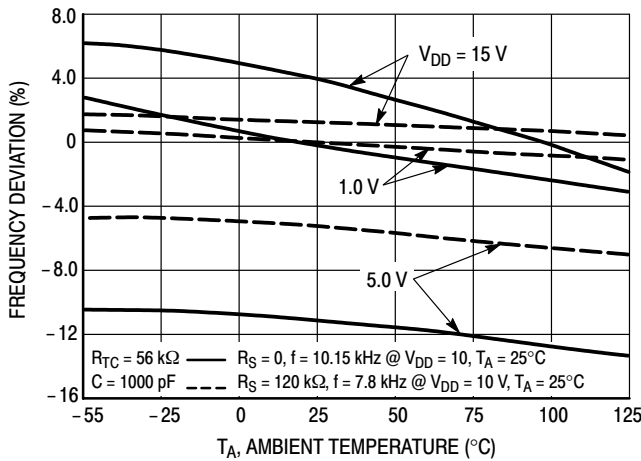

Figure 4. RC Oscillator Stability

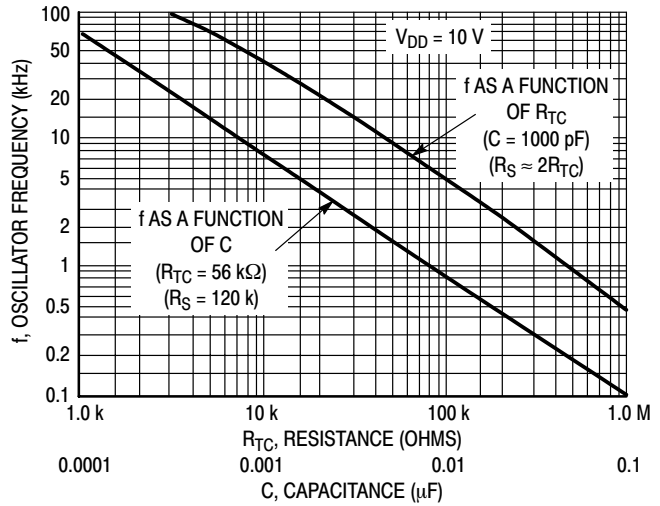

Figure 5. RC Oscillator Frequency as a Function of R_{TC} and C

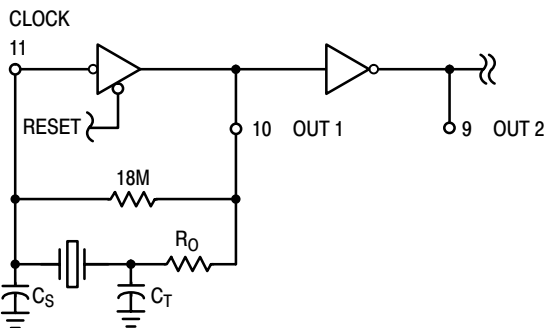

Figure 6. Typical Crystal Oscillator Circuit

Table 2. Typical Data for Crystal Oscillator Circuit

Characteristic	500 kHz Circuit	32 kHz Circuit	Unit
Crystal Characteristics			
Resonant Frequency	500	32	kHz
Equivalent Resistance, R_S	1.0	6.2	k Ω
External Resistor/Capacitor Values			
R_0	47	750	k Ω
C_T	82	82	pF
C_S	20	20	pF
Frequency Stability			
Frequency Changes as a Function of V_{DD} ($T_A = 25^\circ\text{C}$)			
V_{DD} Change from 5.0 V to 10 V	+6.0	+2.0	ppm
V_{DD} Change from 10 V to 15 V	+2.0	+2.0	ppm
Frequency Change as a Function of Temperature ($V_{DD} = 10 \text{ V}$)			
T_A Change from -55°C to $+25^\circ\text{C}$ Complete Oscillator (Note 6)	+100	+120	ppm
T_A Change from $+25^\circ\text{C}$ to $+125^\circ\text{C}$ Complete Oscillator (Note 6)	-160	-560	ppm

6. Complete oscillator includes crystal, capacitors, and resistors.

MC14060B

PACKAGE DIMENSIONS

PDIP-16
P SUFFIX
PLASTIC DIP PACKAGE
CASE 648-08
ISSUE T

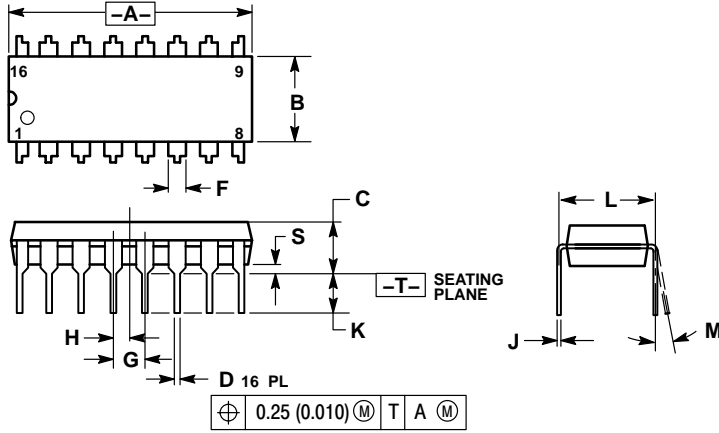

NOTES:

1. DIMENSIONING AND TOLERANCING PER ANSI Y14.5M, 1982.
2. CONTROLLING DIMENSION: INCH.
3. DIMENSION L TO CENTER OF LEADS WHEN FORMED PARALLEL.
4. DIMENSION B DOES NOT INCLUDE MOLD FLASH.
5. ROUNDED CORNERS OPTIONAL.

DIM	INCHES		MILLIMETERS	
	MIN	MAX	MIN	MAX
A	0.740	0.770	18.80	19.55
B	0.250	0.270	6.35	6.85
C	0.145	0.175	3.69	4.44
D	0.015	0.021	0.39	0.53
F	0.040	0.70	1.02	1.77
G	0.100 BSC		2.54 BSC	
H	0.050 BSC		1.27 BSC	
J	0.008	0.015	0.21	0.38
K	0.110	0.130	2.80	3.30
L	0.295	0.305	7.50	7.74
M	0°	10°	0°	10°
S	0.020	0.040	0.51	1.01

SOIC-16
D SUFFIX
PLASTIC SOIC PACKAGE
CASE 751B-05
ISSUE J

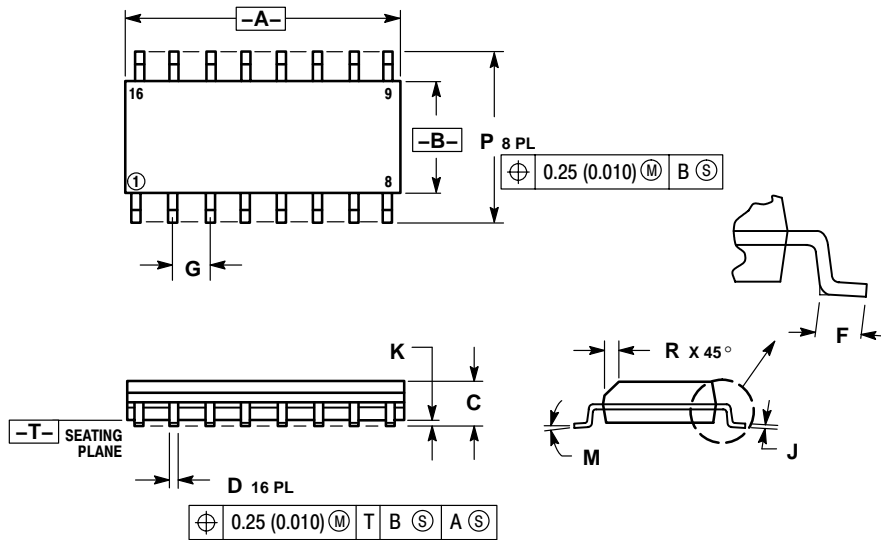

NOTES:

1. DIMENSIONING AND TOLERANCING PER ANSI Y14.5M, 1982.
2. CONTROLLING DIMENSION: MILLIMETER.
3. DIMENSIONS A AND B DO NOT INCLUDE MOLD PROTRUSION.
4. MAXIMUM MOLD PROTRUSION 0.15 (0.006) PER SIDE.
5. DIMENSION D DOES NOT INCLUDE DAMBAR PROTRUSION. ALLOWABLE DAMBAR PROTRUSION SHALL BE 0.127 (0.005) TOTAL IN EXCESS OF THE D DIMENSION AT MAXIMUM MATERIAL CONDITION.

DIM	MILLIMETERS		INCHES	
	MIN	MAX	MIN	MAX
A	9.80	10.00	0.386	0.393
B	3.80	4.00	0.150	0.157
C	1.35	1.75	0.054	0.068
D	0.35	0.49	0.014	0.019
F	0.40	1.25	0.016	0.049
G	1.27 BSC		0.050 BSC	
J	0.19	0.25	0.008	0.009
K	0.10	0.25	0.004	0.009
M	0°	7°	0°	7°
P	5.80	6.20	0.229	0.244
R	0.25	0.50	0.010	0.019

MC14060B

PACKAGE DIMENSIONS

TSSOP-16
DT SUFFIX
PLASTIC TSSOP PACKAGE
CASE 948F-01
ISSUE A

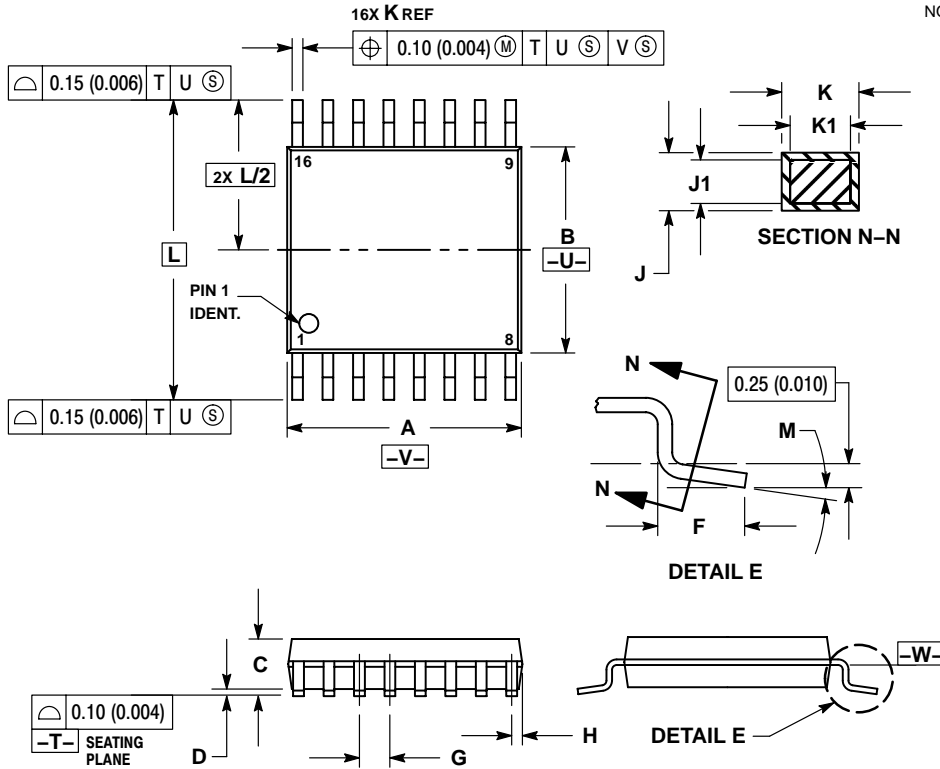

NOTES:

1. DIMENSIONING AND TOLERANCING PER ANSI Y14.5M, 1982.
2. CONTROLLING DIMENSION: MILLIMETER.
3. DIMENSION A DOES NOT INCLUDE MOLD FLASH, PROTRUSIONS OR GATE BURRS. MOLD FLASH OR GATE BURRS SHALL NOT EXCEED 0.15 (0.006) PER SIDE.
4. DIMENSION B DOES NOT INCLUDE INTERLEAD FLASH OR PROTRUSION. INTERLEAD FLASH OR PROTRUSION SHALL NOT EXCEED 0.25 (0.010) PER SIDE.
5. DIMENSION K DOES NOT INCLUDE DAMBAR PROTRUSION. ALLOWABLE DAMBAR PROTRUSION SHALL BE 0.08 (0.003) TOTAL IN EXCESS OF THE K DIMENSION AT MAXIMUM MATERIAL CONDITION.
6. TERMINAL NUMBERS ARE SHOWN FOR REFERENCE ONLY.
7. DIMENSION A AND B ARE TO BE DETERMINED AT DATUM PLANE -W-.

DIM	MILLIMETERS		INCHES	
	MIN	MAX	MIN	MAX
A	4.90	5.10	0.193	0.200
B	4.30	4.50	0.169	0.177
C	---	1.20	---	0.047
D	0.05	0.15	0.002	0.006
F	0.50	0.75	0.020	0.030
G	0.65 BSC		0.026 BSC	
H	0.18	0.28	0.007	0.011
J	0.09	0.20	0.004	0.008
J1	0.09	0.16	0.004	0.006
K	0.19	0.30	0.007	0.012
K1	0.19	0.25	0.007	0.010
L	6.40 BSC		0.252 BSC	
M	0°	8°	0°	8°

MC14060B

PACKAGE DIMENSIONS

SOEIAJ-16 F SUFFIX PLASTIC EIAJ SOIC PACKAGE CASE 966-01 ISSUE O

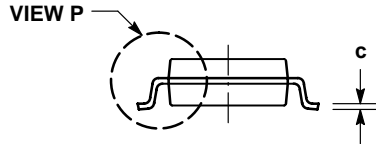
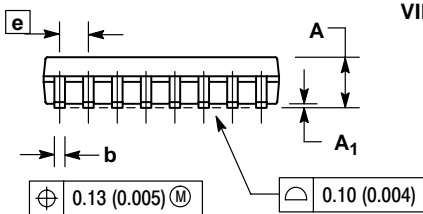
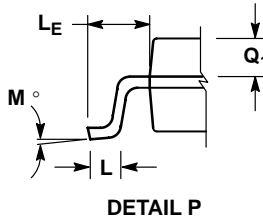
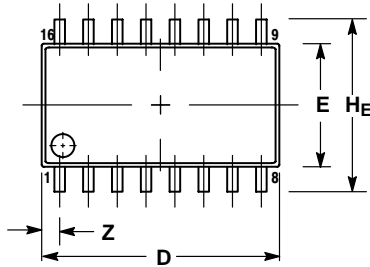

NOTES:

1. DIMENSIONING AND TOLERANCING PER ANSI Y14.5M, 1982.
2. CONTROLLING DIMENSION: MILLIMETER.
3. DIMENSIONS D AND E DO NOT INCLUDE MOLD FLASH OR PROTRUSIONS AND ARE MEASURED AT THE PARTING LINE. MOLD FLASH OR PROTRUSIONS SHALL NOT EXCEED 0.15 (0.006) PER SIDE.
4. TERMINAL NUMBERS ARE SHOWN FOR REFERENCE ONLY.
5. THE LEAD WIDTH DIMENSION (b) DOES NOT INCLUDE DAMBAR PROTRUSION. ALLOWABLE DAMBAR PROTRUSION SHALL BE 0.08 (0.003) TOTAL IN EXCESS OF THE LEAD WIDTH DIMENSION AT MAXIMUM MATERIAL CONDITION. DAMBAR CANNOT BE LOCATED ON THE LOWER RADIUS OR THE FOOT. MINIMUM SPACE BETWEEN PROTRUSIONS AND ADJACENT LEAD TO BE 0.46 (0.018).

DIM	MILLIMETERS		INCHES	
	MIN	MAX	MIN	MAX
A	---	2.05	---	0.081
A ₁	0.05	0.20	0.002	0.008
b	0.35	0.50	0.014	0.020
c	0.18	0.27	0.007	0.011
D	9.90	10.50	0.390	0.413
E	5.10	5.45	0.201	0.215
e	1.27 BSC		0.050 BSC	
H _E	7.40	8.20	0.291	0.323
L	0.50	0.85	0.020	0.033
L _E	1.10	1.50	0.043	0.059
M	0°	10°	0°	10°
Q ₁	0.70	0.90	0.028	0.035
Z	---	0.78	---	0.031

ON Semiconductor and  are registered trademarks of Semiconductor Components Industries, LLC (SCILLC). SCILLC reserves the right to make changes without further notice to any products herein. SCILLC makes no warranty, representation or guarantee regarding the suitability of its products for any particular purpose, nor does SCILLC assume any liability arising out of the application or use of any product or circuit, and specifically disclaims any and all liability, including without limitation special, consequential or incidental damages. "Typical" parameters which may be provided in SCILLC data sheets and/or specifications can and do vary in different applications and actual performance may vary over time. All operating parameters, including "Typicals" must be validated for each customer application by customer's technical experts. SCILLC does not convey any license under its patent rights nor the rights of others. SCILLC products are not designed, intended, or authorized for use as components in systems intended for surgical implant into the body, or other applications intended to support or sustain life, or for any other application in which the failure of the SCILLC product could create a situation where personal injury or death may occur. Should Buyer purchase or use SCILLC products for any such unintended or unauthorized application, Buyer shall indemnify and hold SCILLC and its officers, employees, subsidiaries, affiliates, and distributors harmless against all claims, costs, damages, and expenses, and reasonable attorney fees arising out of, directly or indirectly, any claim of personal injury or death associated with such unintended or unauthorized use, even if such claim alleges that SCILLC was negligent regarding the design or manufacture of the part. SCILLC is an Equal Opportunity/Affirmative Action Employer. This literature is subject to all applicable copyright laws and is not for resale in any manner.

PUBLICATION ORDERING INFORMATION

LITERATURE FULFILLMENT:

Literature Distribution Center for ON Semiconductor
P.O. Box 61312, Phoenix, Arizona 85082-1312 USA
Phone: 480-829-7710 or 800-344-3860 Toll Free USA/Canada
Fax: 480-829-7709 or 800-344-3867 Toll Free USA/Canada
Email: orderlit@onsemi.com

N. American Technical Support: 800-282-9855 Toll Free USA/Canada

Japan: ON Semiconductor, Japan Customer Focus Center
2-9-1 Kamimeguro, Meguro-ku, Tokyo, Japan 153-0051
Phone: 81-3-5773-3850

ON Semiconductor Website: <http://onsemi.com>

Order Literature: <http://www.onsemi.com/litorder>

For additional information, please contact your local Sales Representative.