



Air moving solutions made simple



AC Fans
DC Fans



AC Blowers
DC Blowers



AC Impellers
DC Impellers



AC
Motors



Accessories

Search

Part/Model #
Stock Check
Cross-Reference
Keyword

More Products

Heat Sinks
Fan Accessories

Engineering Tools

Airflow Calculator
Thermal Calculator
Unit Conversions
Application Notes

Custom Solutions

Company Info

Contact Info
Technical Capability
Certifications
Terms & Conditions
Employment Ops

Gateway Online

Phone: 858.348.6200 FAX: 858.566.4577

Distributors

Find a Rep

Contact Us

Muffin - MC12A7 - 032228 - No
(Family) (Model) (Part #) (In Stock)

Electrical Specifications

Operating Voltage:	12 Volts
Voltage Range:	6 - 14 Volts
Power Supply:	7.9 Watts
Line Current:	0.66 Amps
Locked Rotor Current	1.75 Amps
Nominal Speed:	3700 RPM

Mechanical Specifications

Dimensions:	4.7 x 4.7 x 1.3 in
Weight	8.5 oz
Max Airflow @ 0 in H ₂ O	102.0 CFM
Max Pressure @ 0 CFM	0.350 in H ₂ O
Noise	47.8 dBA



Detailed
Drawing



Printer-Friendly
Datasheet

Mechanical Drawing

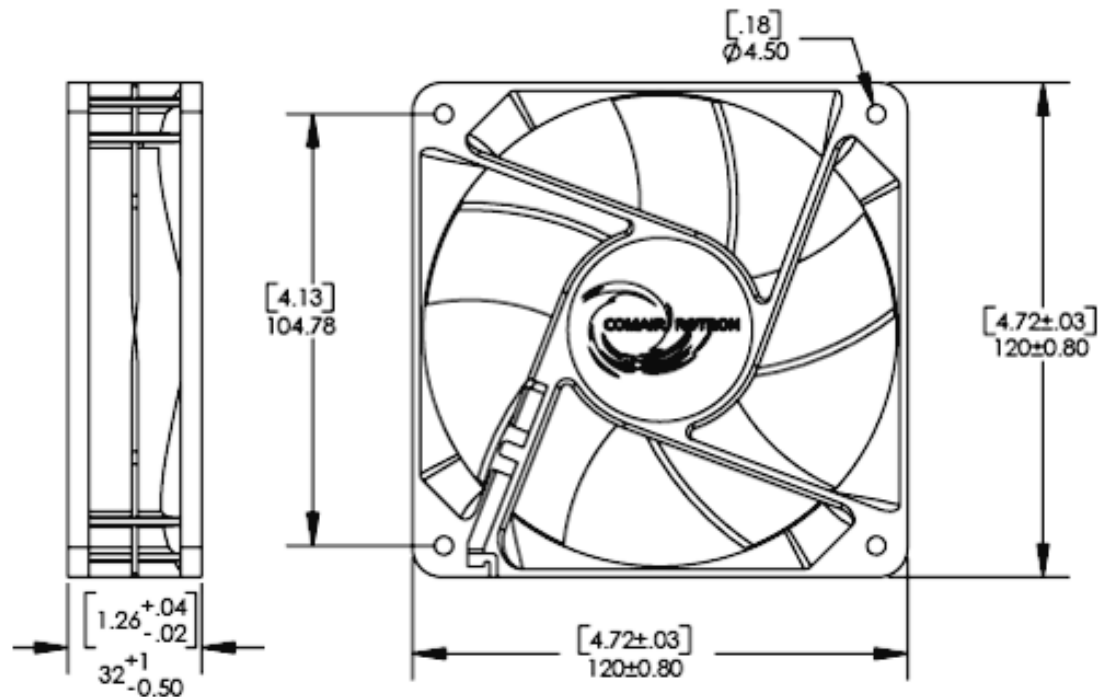

Fan Performance Curve

Fan Configuration Options

Muffin (Family)	MC12A7 (Model)	/ 032228 (Part #)	No (In Stock)	305 mm [12 inch] Leads (Features)
Fan Speeds	Fan Bearings		Fan Airflow Directions	
High Speed (4500 RPM)	Ball Bearings		Flow L (CW Rotation)	
Full Speed (3700 RPM)	Sleeve Bearings		Flow R (CCW Rotation)	
7/8 Speed (3250 RPM)				
3/4 Speed (2900 RPM)				
1/2 Speed (2170 RPM)				
Fan Terminations				
Leads				
Terminals				

No Fan Monitoring Options Required

Add Tachometer (2 pulses per revolution.)

Open Collector Output

TTL (+5V) Output

Existing Models with Tachometer Option:

MC12A7 / 032228	MC12B7 / 030598	MC12F7 / 030883	MC12G7 / 030814
MC12H7 / 031710	MC12J7 / 030706	MC12P7 / 032444	MC12R7 / 030603
MC12T7H / 032450	MC12T7HX / 031872		

Add Fan Performance Sensor (FPS)

Fan Speed Control Options

Add ThermaPro-V Fan Speed Control

Environmental Protection Options

Add Enviroshield Environmental Protection

Accessories (Click on part number for detailed drawing.)

**477663
Mounting Clip**

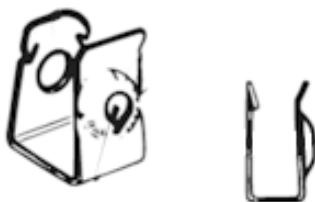

**551590
Filter Assembly**

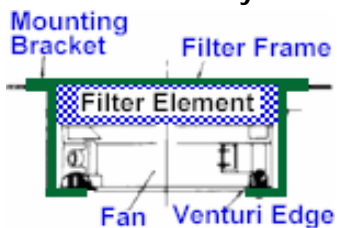

**554148
Filter Guard Assembly**

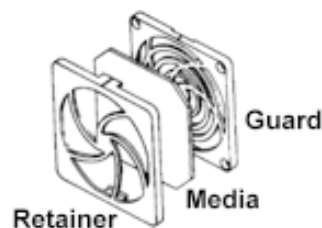

**552934
Finger Guard**

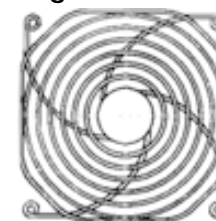

**476042
Finger Guard**

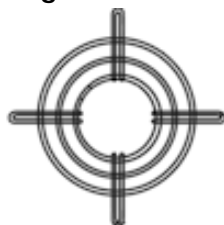

**550481
Finger Guard**



**551147
Finger Guard**

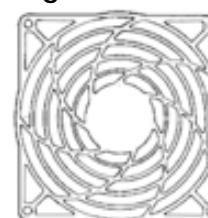

Comair Rotron, Inc.

Phone: 858.348.6200

FAX: 858.566.4577

sales@comairrotron.com

ThermaFlo, Inc.

Phone: 972.312.8609

FAX: 972.312.8617

info@thermaflo.com

Comair Rotron Europe, Ltd.

Phone: +44.1527.520525

FAX: +44.1527.520565

saleseurope@comairrotron.com

Comair Rotron Fan Company Ltd.

Phone: +86.21.52260581

FAX: +86.21.52260597

salesasia@comairrotron.com