



Low Noise GaAs MMIC Amplifier

2–3 GHz

MAAM23000

Features

- 1.1 dB Typical Noise Figure¹
- 26 dB Typical Gain¹
- On-Chip Bias Network
- DC Decoupled RF Input and Output

Electrical Specifications @ Ta = 25°C

Frequency Range	2.0–3.0 GHz	
Gain ¹	26.0 dB Typ	24.0 dB Min
Gain Flatness	±1.0 dB Typ	
Noise Figure ¹	1.6 dB Max	1.1 dB Typ
VSWR ¹	Input	1.7:1 Typ
	Output	1.3:1 Typ
Output Power at 1 dB Gain Compression	+14 dBm Typ	
Third Order Intercept	+24 dBm Typ	
Reverse Isolation	40 dB Typ	
Impedance	50 Ω Typ	
Bias Voltage	Vdd = +5 Vdc, Vgg = -5 Vdc	
Bias Conditions	Idd = 80 mA Typ, 110 mA Max Igg = 1.0 mA Typ, 1.5 mA Max	

Maximum Ratings

Voltage	+7v@Vdd, -10v@Vgg
Input Power	+20 dBm
Storage Temperature	-65°C to +150°C
Operating Temperature	-55°C to +125°C

1. 100% on-wafer tested.

Schematic

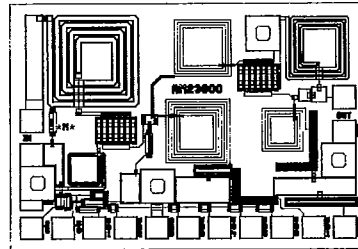
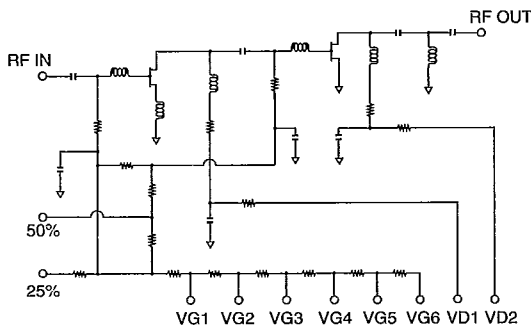

Typical Performance

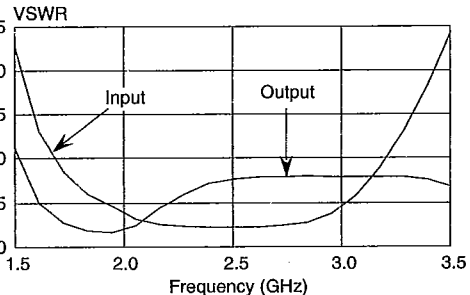
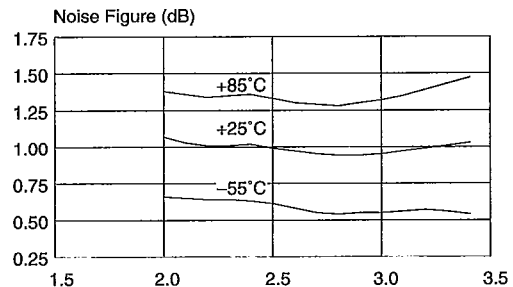
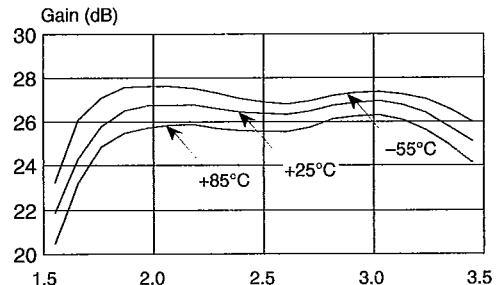

Specifications Subject to Change Without Notice

M/A-COM Inc.

1011 Pawtucket Boulevard, Lowell, MA 01853 USA

Telephone: 800-366-2266

Handling, Mounting and Bonding Procedures

MAAM23000

Handling

Permanent damage to the MAAM23000 may occur if the following precautions are not adhered to:

- Cleanliness** — The MAAM23000 should be handled in a clean environment. DO NOT attempt to clean assembly after the MAAM23000 is installed.
- Static Sensitivity** — All die handling equipment and personnel should comply with DOD-STD-1686 Class I.
- Transients** — Avoid instrument and power supply transients while bias is connected to the MAAM23000. Use shielded signal and bias cables to minimize inductive pick-up.
- General Handling** — DO NOT touch the surface of the die. It is recommended that the MAAM23000 die be handled along the long side with a sharp pair of tweezers.

Mounting

The MAAM23000 is back-metallized with Pd/Ni/Au (100/1,000/30,000Å) metallization. It can be die-mounted using Au/Sn eutectic preforms or a thermally and electrically conductive epoxy. The attachment surface should be clean and flat.

Eutectic Die Attach:

- An 80/20 Au/Sn preform is recommended with a work surface temperature of approximately 255°C and a tool temperature of 265°C. When hot 95/5 nitrogen/hydrogen gas is applied, solder temperature should be approximately 290°C.
- DO NOT expose the MAAM23000 to a temperature greater than 320°C for more than 20 seconds. No more than 3 seconds of scrubbing should be required for attachment.

Epoxy Die Attach:

- Electrically conductive epoxy is required.
- Apply a minimum amount of epoxy and place the MAAM23000 into position. A thin epoxy fillet should be visible around the perimeter of the die.
- Cure epoxy per manufacturer's recommended schedule.

Bonding

- Ball or wedge bond with 1.0 mil diameter gold wire or 3.0 mil x 0.5 mil ribbon. Thermosonic bonding with a nominal stage temperature of 150°C and a ball bonding force of 40 to 50 grams or wedge bonding force of 18 to 22 grams is recommended. Ultrasonic energy and time should be adjusted to the minimum levels necessary to achieve reliable bonds.
- Bonds should be started on the die and terminated on the package.
- Bonding pads are 4.0 x 4.0 mils.

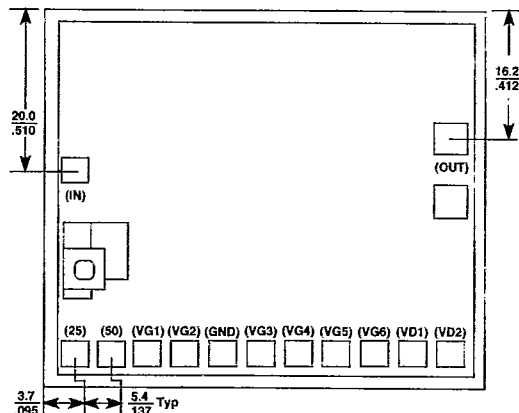
Outline

All dimensions are in mils.

Die Size

0.061" X 0.043" X 0.004"
(1.560mm X 1.080mm X 0.102mm)

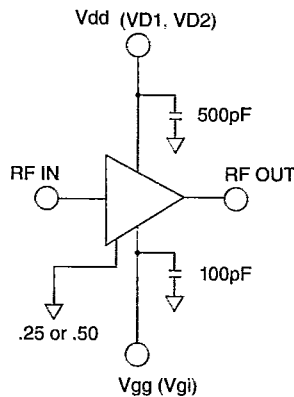
Typical Bias Configuration

- Nominal bias is obtained by grounding pad .50 and connecting Vgg to pad VG4.
- Grounding pad .25, instead of pad .50, will decrease second stage current.
- Optional biasing can be obtained by connecting Vgg to pads VG1, VG2, VG3, VG5, or VG6, instead of VG4. Connecting to VG1 results in the lowest current; VG6 will yield the highest current. Adjusting the bias can customize performance to suit special requirements.

Specifications Subject to Change Without Notice

M/A-COM Inc.

1011 Pawtucket Boulevard, Lowell, MA 01853 USA

Telephone: 800-366-2266