

Variable Gain Amplifier with Analog Control 400 - 2700 MHz

Rev. V1

Features

- Wide Frequency Range
- +42 dBm Output IP3
- 25.5 dB Gain at 2140 MHz
- 26.5 dB Attenuation Range
- Lead-Free 4 mm, 24-Lead PQFN Package
- RoHS* Compliant and 260°C Reflow Compatible

Description

The MAAM-009320 is a variable gain amplifier with 26.5 dB of gain control at 2.14 GHz. It has good input IP3 performance over the full attenuation range. External matching components are used to set the center frequency and achieve the return loss performance. The analog control is accomplished through a single control pin of 0 to +3V.

The 4 mm PQFN package is RoHS compliant and compatible with reflow temperatures to 260°C. Applications include transceivers for cellular infrastructure.

Ordering Information^{1,2}

Part Number	Package
MAAM-009320-TR3000	3000 piece reel
MAAM-009320-001SMB	Sample Board, 2140 MHz

1. Reference Application Note M513 for reel size information.
2. All sample boards include 5 loose parts.

Functional Schematic

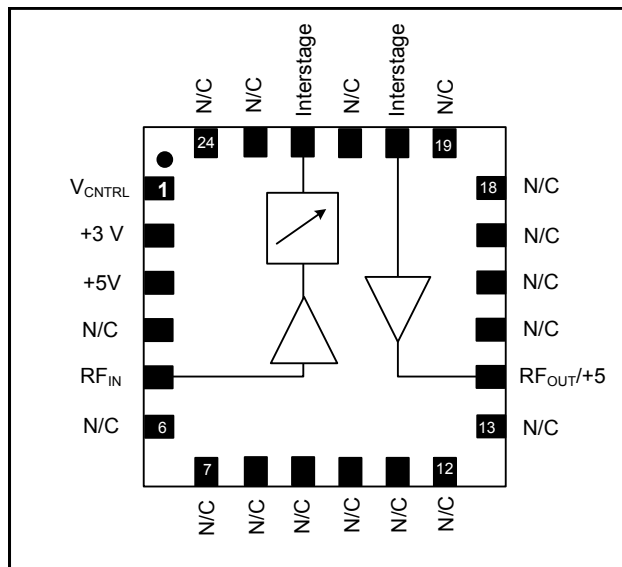

Pin Configuration³

Pin No.	Function	Pin No.	Function
1	V _{CNTRL}	13	N/C
2	+3V	14	RF _{OUT} /+5V
3	+5V	15	N/C
4	N/C	16	N/C
5	RF _{IN}	17	N/C
6	N/C	18	N/C
7	N/C	19	N/C
8	N/C	20	Interstage
9	N/C	21	N/C
10	N/C	22	Interstage
11	N/C	23	N/C
12	N/C	24	N/C
		25	Paddle ⁴

3. For optimum RF performance, all N/C's should be terminated to ground.
4. The exposed pad centered on the package bottom must be connected to RF and DC ground.

* Restrictions on Hazardous Substances, European Union Directive 2002/95/EC.

Variable Gain Amplifier with Analog Control 400 - 2700 MHz

Rev. V1

Electrical Specifications^{5,6,7}: Freq. = 2140 MHz, T_A = +25°C, Z₀ = 50 Ω

Parameter	Units	Min.	Typ.	Max.
Gain	dB	24	25.5	—
Noise Figure	dB	—	3.0	—
Input Return Loss	dB	—	13	—
Output Return Loss	dB	—	12	—
Output P1dB	dBm	—	28	—
Output IP3 P _{out} = +9 dBm per tone SCL, 1 MHz spacing	dBm	40	42	—
Attenuation Range	dB	25	26.5	—
Attenuation Control	V	—	0 to 3	—
Small Signal Current	mA	—	231	300

- Contact M/A-COM Technology Solutions' Application Engineering Department for performance and tuning at other frequencies within frequency range.
- Typical performance at no attenuation, V_{cntrl} = 0V.
- Typical small signal currents are 76 mA for stage 1 and 155 mA for stage 3.

Absolute Maximum Ratings^{8,9}

Parameter	Absolute Maximum
Input Power	+6 dBm
Voltage (all DC pins)	6 volts
Storage Temperature	-55°C to +150°C
Case Temperature	-40°C to +85°C
Junction Temp, Stage 1 ^{10,11}	150°C
Junction Temp, Stage 3 ^{10,12}	160°C

- Exceeding any one or combination of these limits may cause permanent damage to this device.
- M/A-COM Technology Solutions does not recommend sustained operation near these survivability limits.
- Junction Temperature (T_J) = T_A + Θ_{jc} * ((V * I) - (P_{OUT} - P_{IN}))
- Stage 1 typical thermal resistance (Θ_{jc}) = 106.5° C/W
- Stage 3 typical thermal resistance (Θ_{jc}) = 68.6° C/W

Handling Procedures

Please observe the following precautions to avoid damage:

Static Sensitivity

Gallium Arsenide Integrated Circuits are sensitive to electrostatic discharge (ESD) and can be damaged by static electricity. Proper ESD control techniques should be used when handling these class 1A devices.

Variable Gain Amplifier with Analog Control 400 - 2700 MHz

Rev. V1

Typical Performance Curves:

Gain, $V_{ctrl} = 0V$

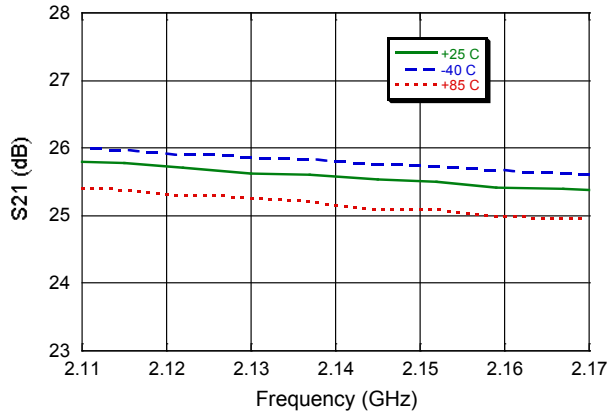

Attenuation Range

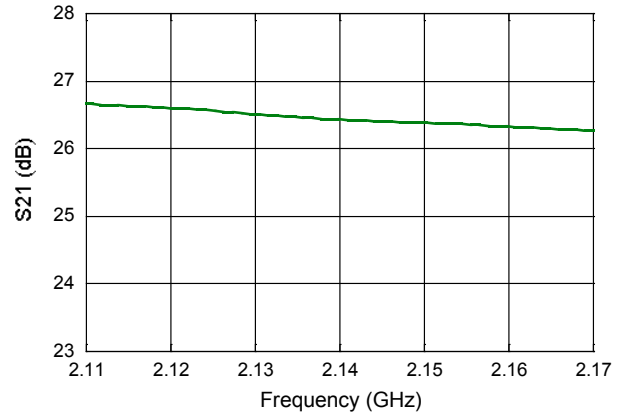

Gain vs. Control Voltage

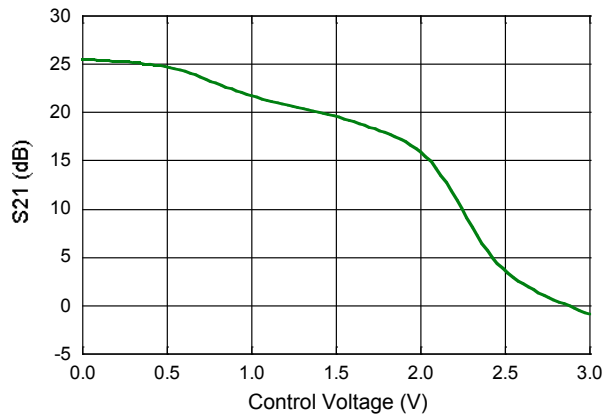

Reverse Isolation, $V_{ctrl} = 0V$

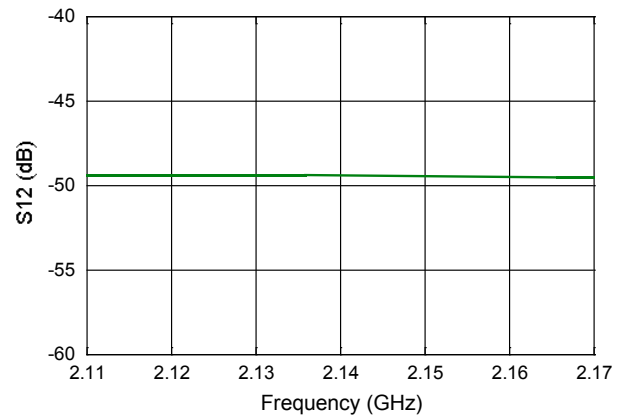

Input Return Loss

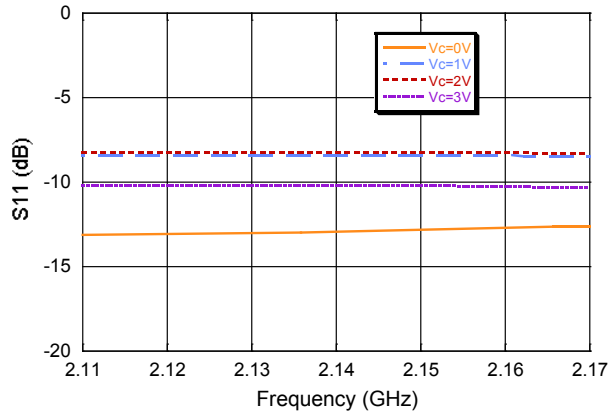

Output Return Loss

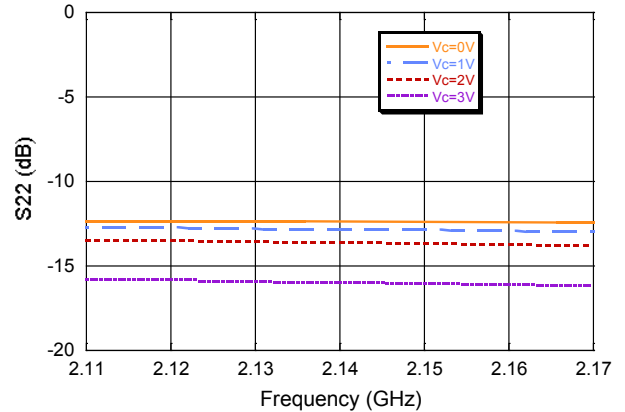

Typical Performance Curves:

Output IP3, Vcntrl = 0V

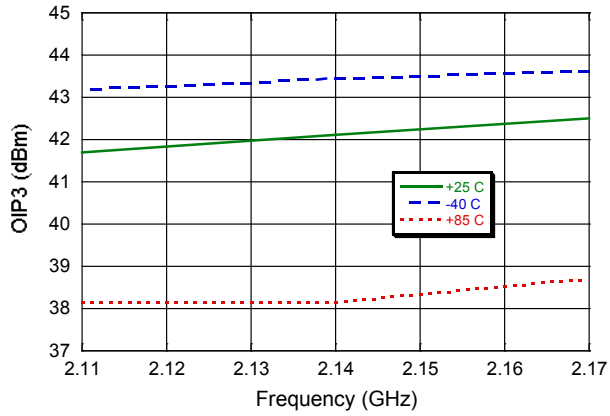

Input IP3 vs. Control Voltage

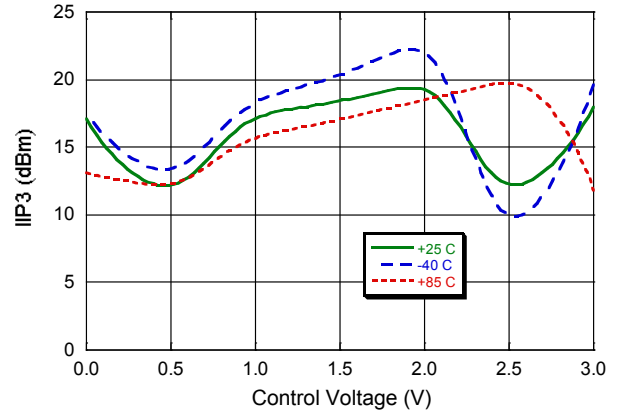

Output P1dB, Vcntrl = 0V

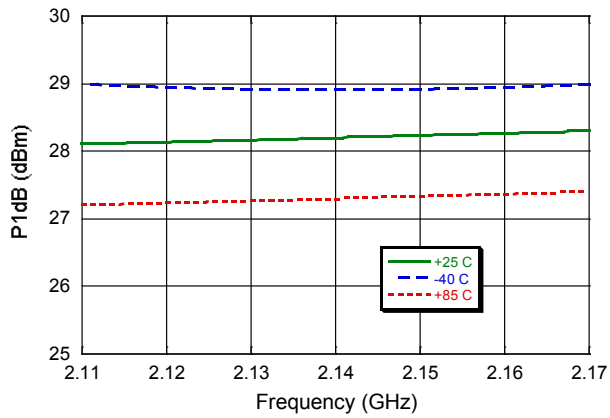

Input P1dB vs. Control Voltage

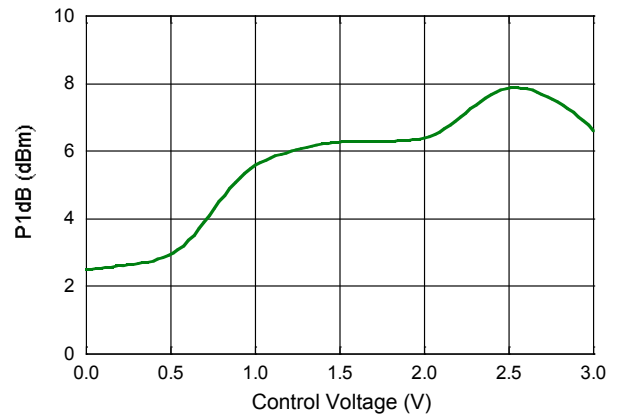

Noise Figure, Vcntrl = 0V

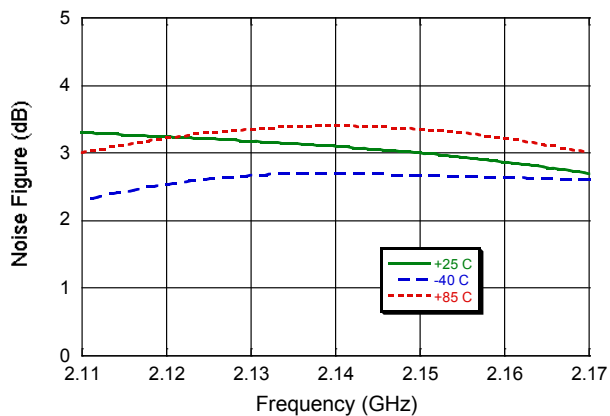

Noise Figure vs. Control Voltage

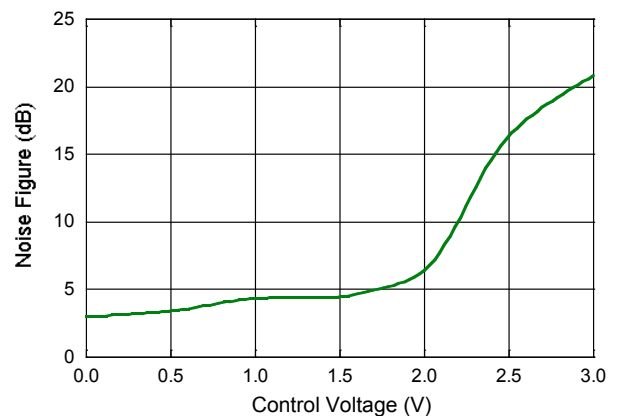

Variable Gain Amplifier with Analog Control 400 - 2700 MHz

Rev. V1

2140 MHz PCB Layout

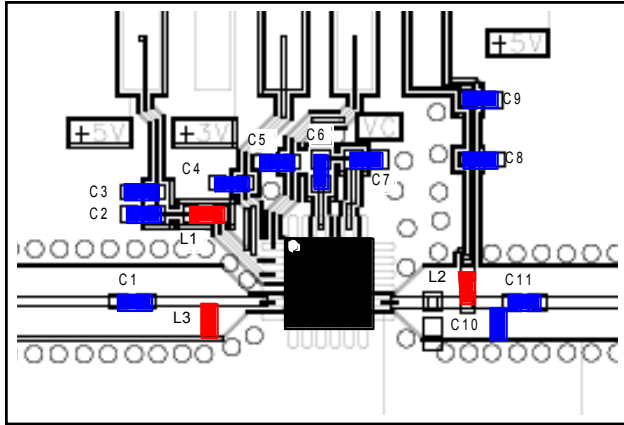

Parts List

Part	Value	Case Style
C1	68 pF	0402
C2, C4, C5, C8	1000 pF	0402
C3, C9	0.1 μF	0402
C6	12 pF	0402
C7	2.2 pF	0402
C10	1.5 pF	0402
C11	39 pF	0402
L1	39 nH	0402
L2	7.5 nH	0402
L3	3.9 nH	0402

2140 MHz Schematic

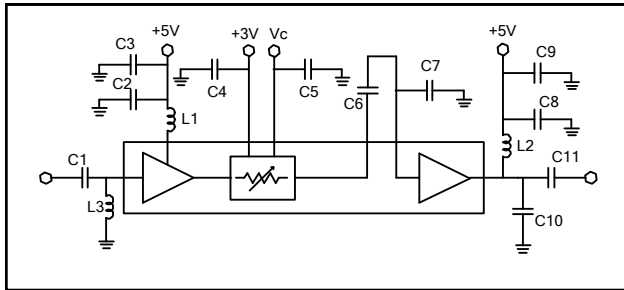

Cross Section View

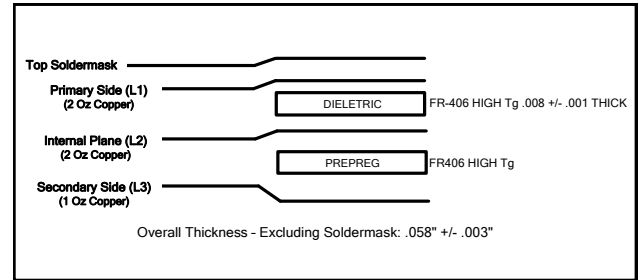

Lead Free 4 mm 24-Lead PQFN †

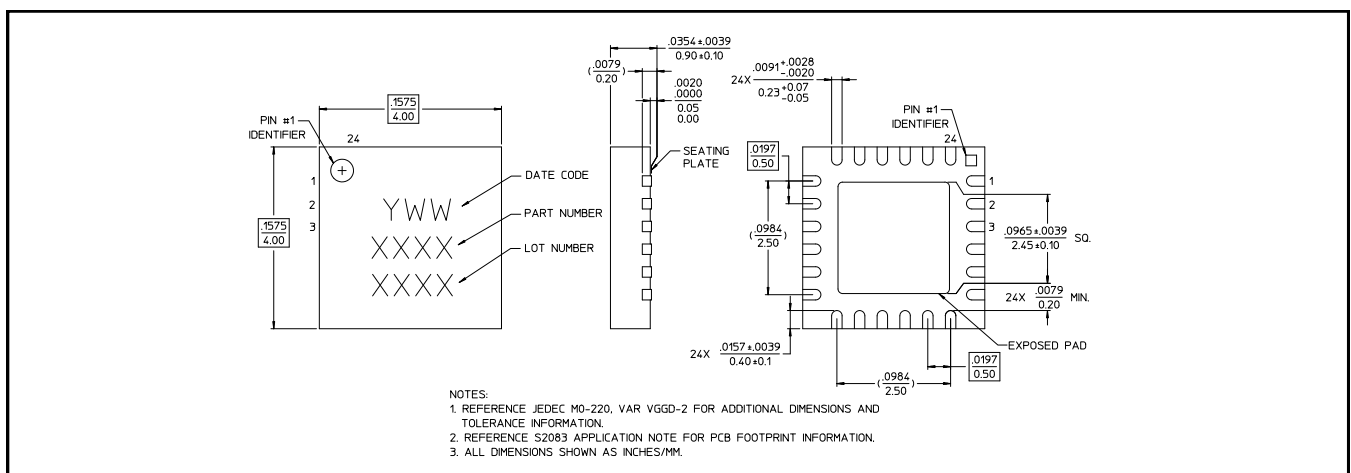

† Reference Application Note M538 for lead-free solder reflow recommendations.
 Meets JEDEC moisture sensitivity level 1 requirements.
 Plating is 100% matte tin over copper.

400 MHz Applications Section

Schematic

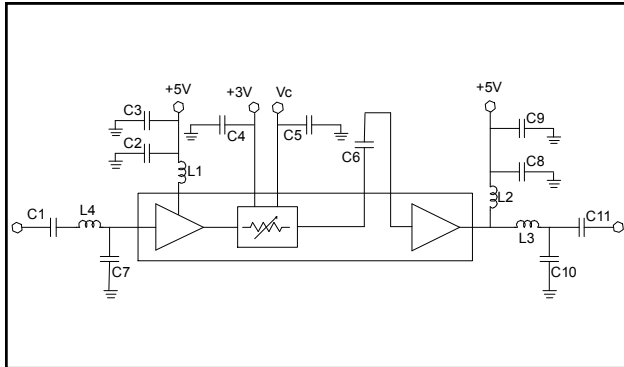

Parts List

Part	Value	Case Style
C1, C11	39 pF	0402
C2, C4, C5, C8	1000 pF	0402
C3, C9	0.1 μ F	0402
C6	4.7 pF	0402
C7	4 pF	0402
C10	18 pF	0402
L1	39 nH	0402
L2	7.5 nH	0402
L3	3.9 nH	0402
L4	12 nH	0402

Gain, Vcntrl = 0V

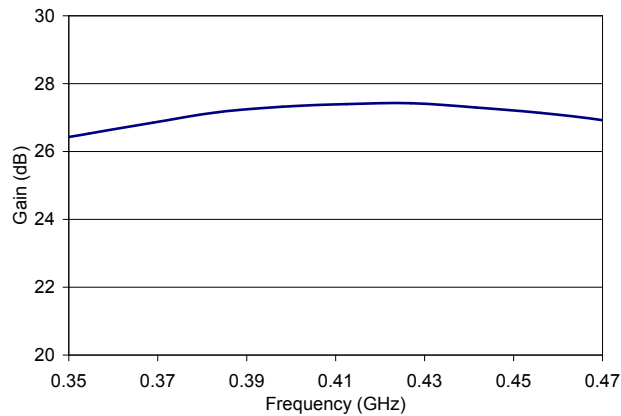

Attenuation Range

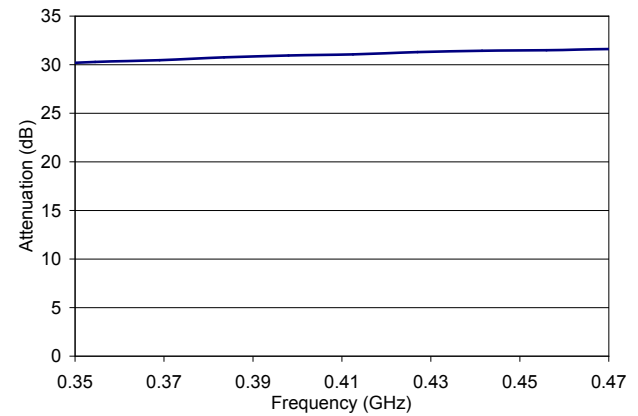

400 MHz Applications Section

Input Return Loss

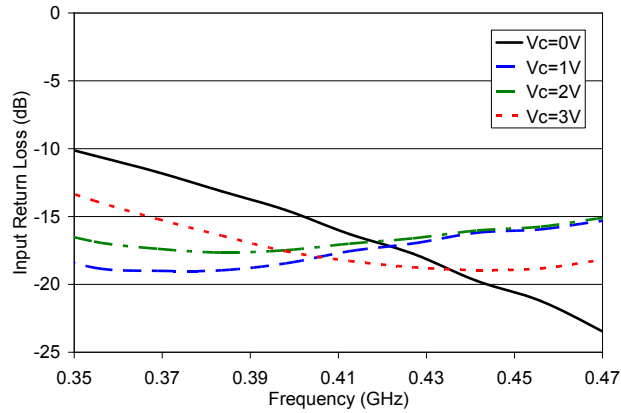

Output Return Loss

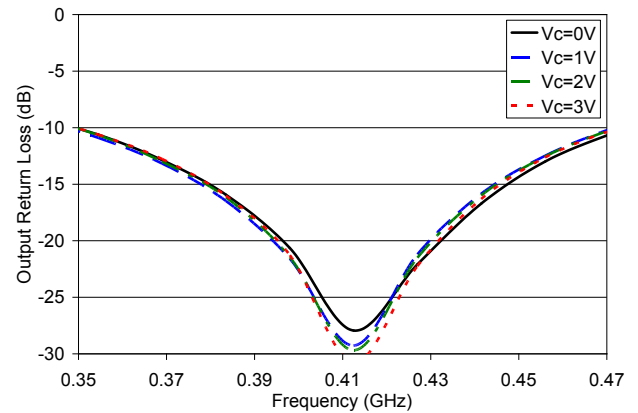

Output IP3, Vcntrl = 0V

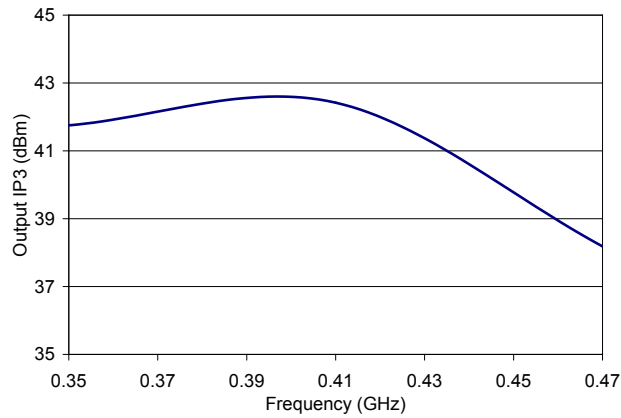

Input IP3 vs. Control Voltage

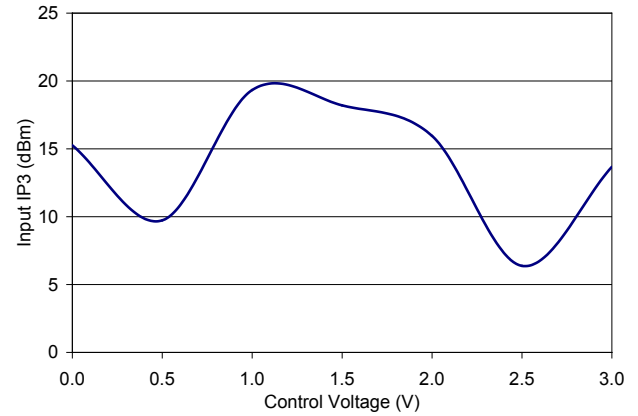

Output P1dB, Vcntrl = 0V

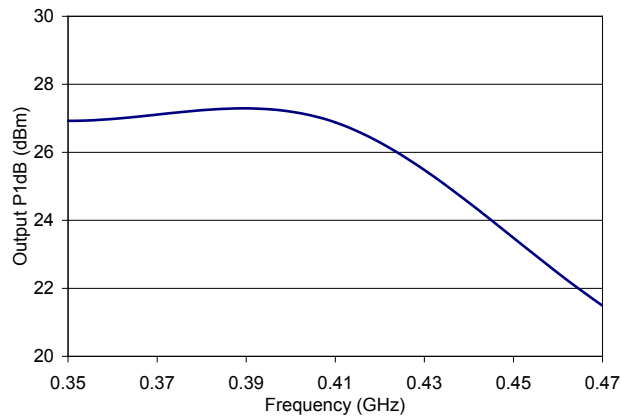

Input P1dB vs. Control Voltage

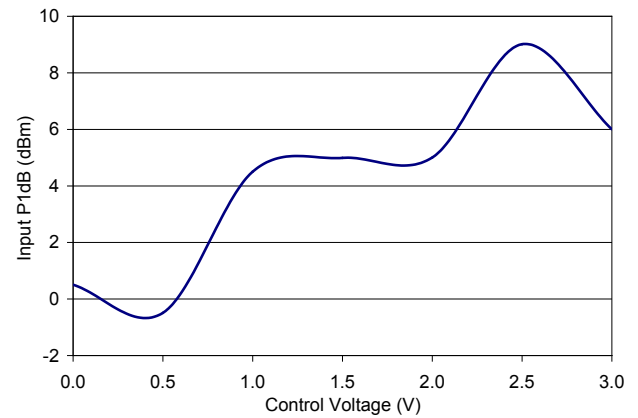

850 MHz Applications Section

Schematic

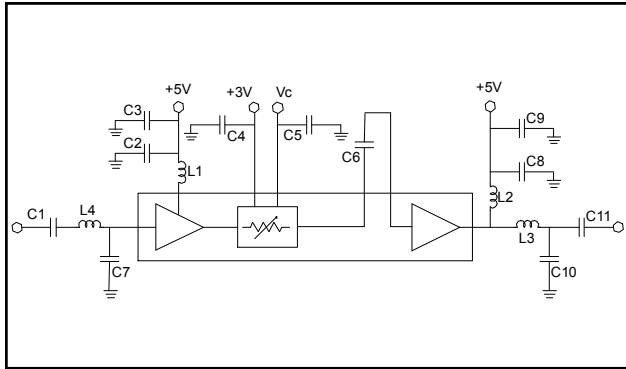

Parts List

Part	Value	Case Style
C1, C11	39 pF	0402
C2, C4, C5, C8	1000 pF	0402
C3, C9	0.1 μ F	0402
C6	4.7 pF	0402
C7	1.2 pF	0402
C10	6.8 pF	0402
L1	39 nH	0402
L2	7.5 nH	0402
L3	1 nH	0402
L4	10 nH	0402

Gain, Vcntrl = 0V

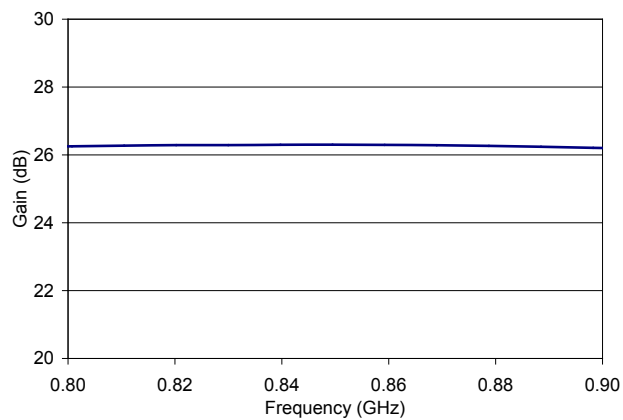

Attenuation Range

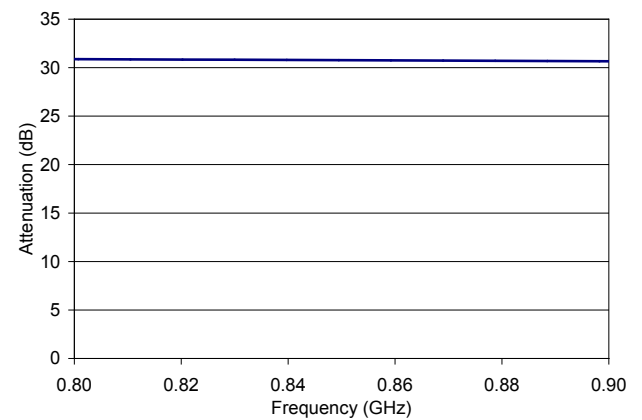

850 MHz Applications Section

Input Return Loss

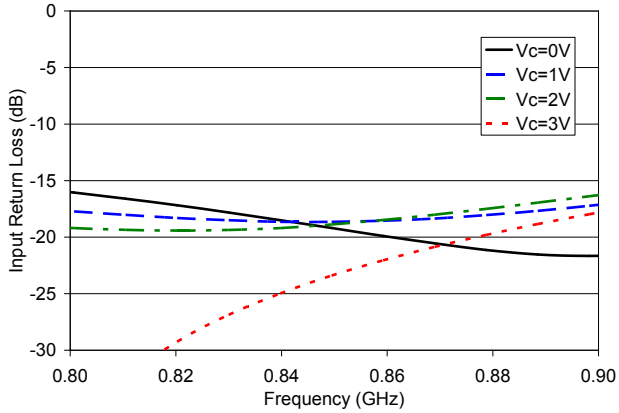

Output Return Loss

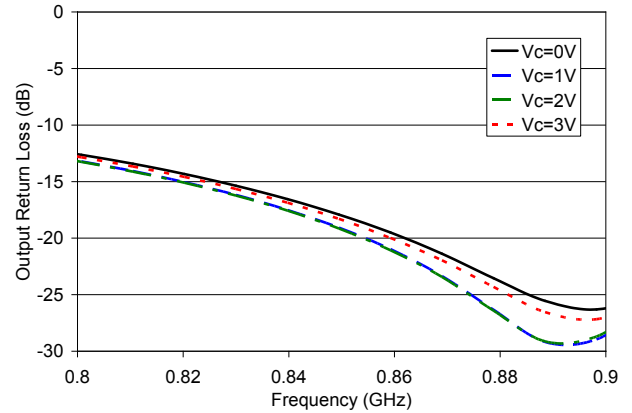

Output IP3, Vctrl = 0V

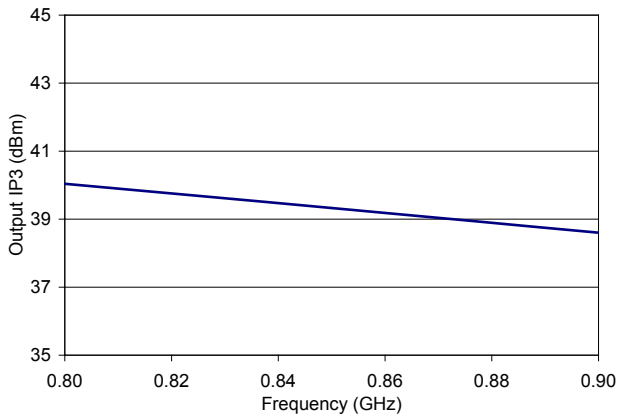

Input IP3 vs. Control Voltage

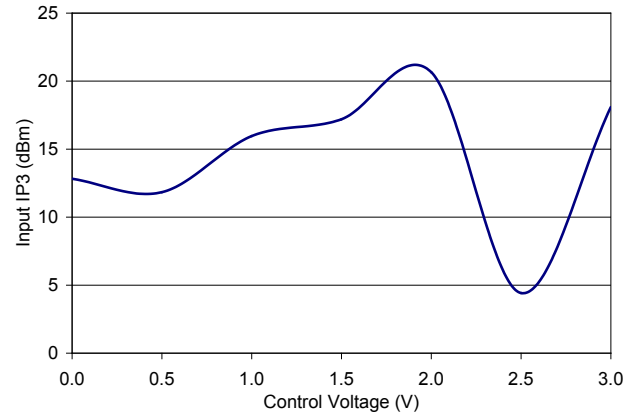

Output P1dB, Vctrl = 0V

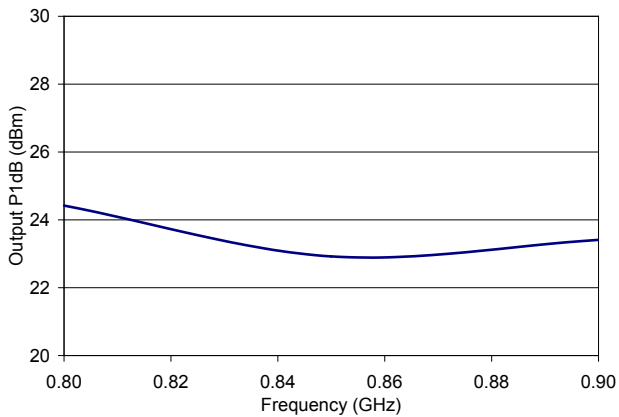

Input P1dB vs. Control Voltage

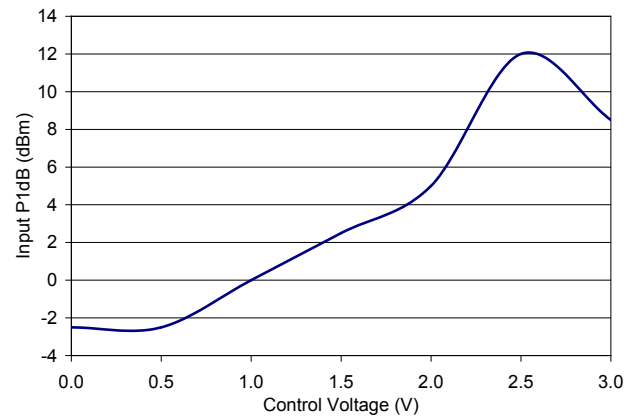

2600 MHz Applications Section

Schematic

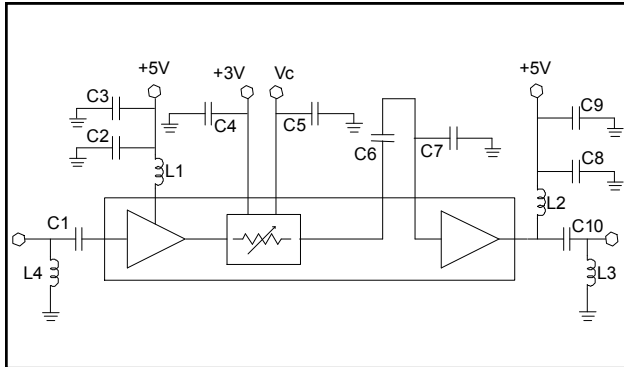

Parts List

Part	Value	Case Style
C1	3.9 pF	0402
C2, C4, C5, C8	1000 pF	0402
C3, C9	0.1 μ F	0402
C6	6.8 pF	0402
C7	1.2 pF	0402
C10	1 pF	0402
L1	39 nH	0402
L2	7.5 nH	0402
L3	1.8 nH	0402
L4	3.9 nH	0402

Gain, Vcntrl = 0V

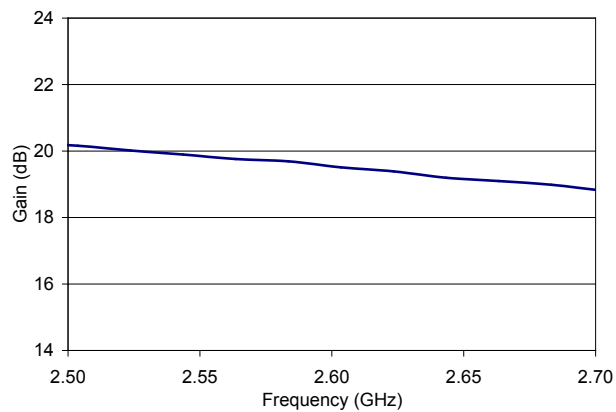

Attenuation Range

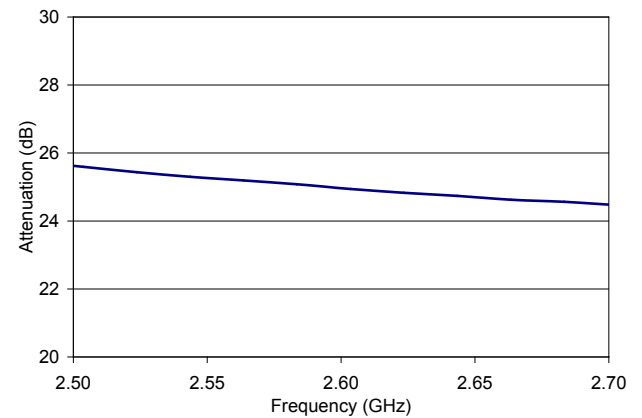

2600 MHz Applications Section

Input Return Loss

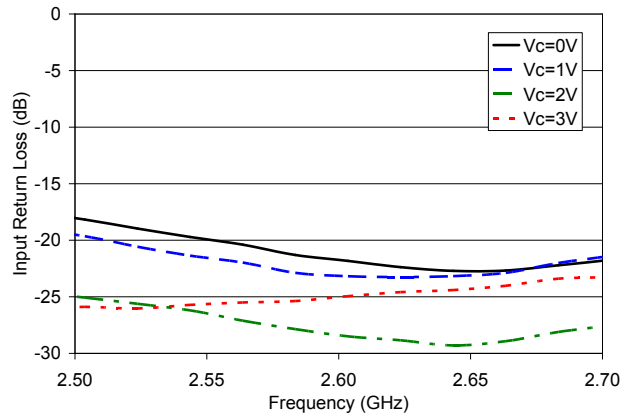

Output Return Loss

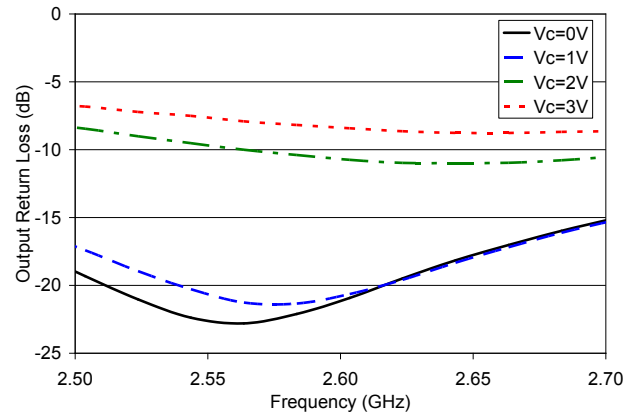

Output IP3, Vcntrl = 0V

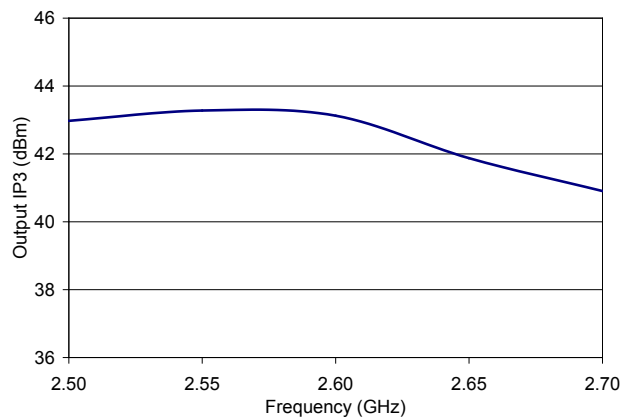

Input IP3 vs. Control Voltage

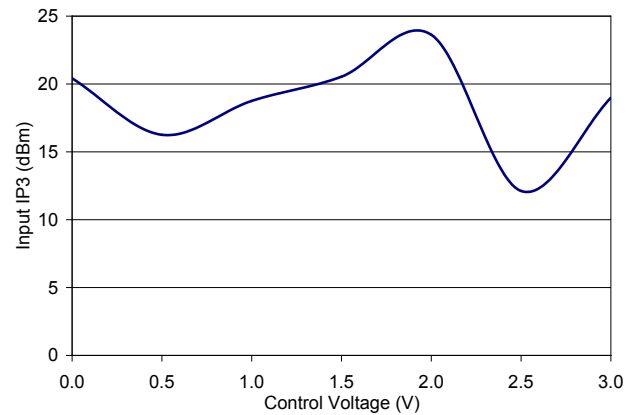

Output P1dB, Vcntrl = 0V

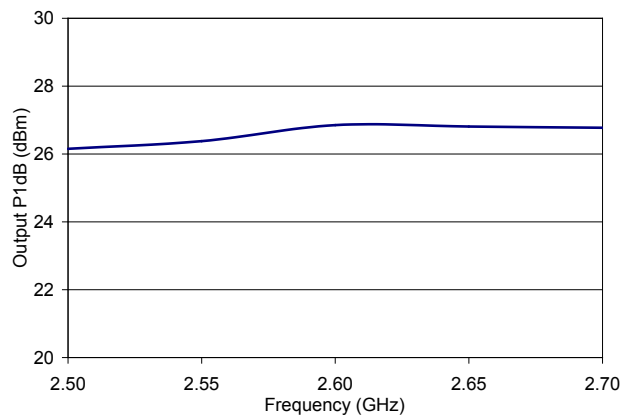

Input P1dB vs. Control Voltage

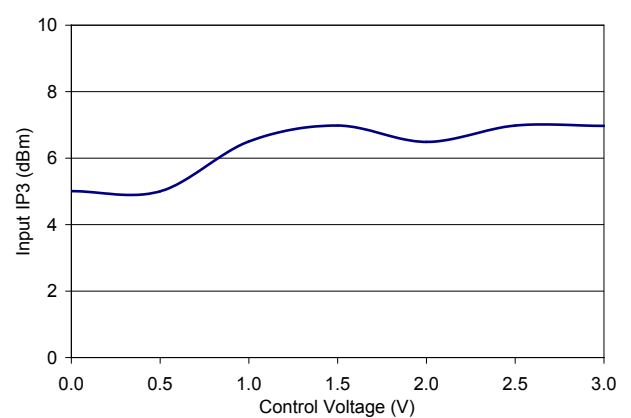

M/A-COM Technology Solutions Inc. All rights reserved.

Information in this document is provided in connection with M/A-COM Technology Solutions Inc ("MACOM") products. These materials are provided by MACOM as a service to its customers and may be used for informational purposes only. Except as provided in MACOM's Terms and Conditions of Sale for such products or in any separate agreement related to this document, MACOM assumes no liability whatsoever. MACOM assumes no responsibility for errors or omissions in these materials. MACOM may make changes to specifications and product descriptions at any time, without notice. MACOM makes no commitment to update the information and shall have no responsibility whatsoever for conflicts or incompatibilities arising from future changes to its specifications and product descriptions. No license, express or implied, by estoppel or otherwise, to any intellectual property rights is granted by this document.

THESE MATERIALS ARE PROVIDED "AS IS" WITHOUT WARRANTY OF ANY KIND, EITHER EXPRESS OR IMPLIED, RELATING TO SALE AND/OR USE OF MACOM PRODUCTS INCLUDING LIABILITY OR WARRANTIES RELATING TO FITNESS FOR A PARTICULAR PURPOSE, CONSEQUENTIAL OR INCIDENTAL DAMAGES, MERCHANTABILITY, OR INFRINGEMENT OF ANY PATENT, COPYRIGHT OR OTHER INTELLECTUAL PROPERTY RIGHT. MACOM FURTHER DOES NOT WARRANT THE ACCURACY OR COMPLETENESS OF THE INFORMATION, TEXT, GRAPHICS OR OTHER ITEMS CONTAINED WITHIN THESE MATERIALS. MACOM SHALL NOT BE LIABLE FOR ANY SPECIAL, INDIRECT, INCIDENTAL, OR CONSEQUENTIAL DAMAGES, INCLUDING WITHOUT LIMITATION, LOST REVENUES OR LOST PROFITS, WHICH MAY RESULT FROM THE USE OF THESE MATERIALS.

MACOM products are not intended for use in medical, lifesaving or life sustaining applications. MACOM customers using or selling MACOM products for use in such applications do so at their own risk and agree to fully indemnify MACOM for any damages resulting from such improper use or sale.