



**Industrial Grade
SD Card & SDChip™
Product Manual**

November 2008

Corporate Headquarters
Suite C, 15/F, Capital Trade Center
62 Tsun Yip Street, Kwun Tong
Kowloon, Hong Kong

*The information in this manual is believed to be accurate at the time of publication but is **subject to change without notice**. Cactus[®] Technologies Limited shall not be liable for technical or editorial errors or omissions contained herein; nor for incidental or consequential damages resulting from the furnishing, performance, or use of this material.*

Cactus makes no warranty, representation or guarantee regarding the suitability of its products for any particular purpose, nor does Cactus assume any liability arising out of the application or use of its products, and specifically disclaims any and all liability, including without limitation consequential or incidental damages.

Cactus products are not designed, intended or authorized for use as components in systems intended for surgical implant into the body or in other applications intended to support or sustain life or for any application where the failure of a Cactus product can result in personal injury or death. Users of Cactus products for such unintended and unauthorized applications shall assume all risk of such use and shall indemnify and hold Cactus and its officers, employees, subsidiaries, affiliates and distributors harmless against all claims, costs, damages, expenses and attorney fees arising out of, directly or indirectly, any claim of personal injury or death associated with such unintended and unauthorized use, even if such claim alleges that Cactus was negligent regarding the design or manufacture of the part.

All parts of the Cactus documentation are protected by copyright law and all rights are reserved. This documentation may not, in whole or in part, be copied, photocopied, reproduced, translated, or reduced to any electronic medium or machine-readable form without prior consent, in writing, from Cactus Corporation.

Cactus Technologies and the Cactus logo are registered trademarks of Cactus Technologies Limited.

© 2006, 2007, 2008 Cactus Technologies Limited. All rights reserved.

1.Introduction to Cactus Technologies Industrial Grade SD Card & SDChip™ Products

Features:

- Solid state design with no moving parts
- Up to 8GB of storage for SD Cards, up 4GB of storage for SDChip™
- Compatible with SDA Physical Layer Specifications, Version 2.0
- Supports SD command class 0,2,4,5,6,7,8,10
- Supports CPRM
- Supports SPI mode

Overview:

- Supports 0-25MHz operation(default) or 0-50MHz operation(high speed)
- High reliability, MTBF > 4,000,000 hrs.
- Enhanced error correction, < 1 error in 10¹⁵ bits read
- Up to 22MB/s data rate (using 4 data lines)
- Voltage range 2.7V-3.6V

The Cactus Technologies SD products are low capacity solid-state flash memory products that complies with the SD Card Association standard. Cactus SD Cards provide up to 8GB of formatted storage capacity and is designed to be used in applications which requires reliable, high performance solid state storage in a small form factor.

Cactus Technologies Industrial Grade SDChip™ provides up to 4GB of formatted storage capacity in a small 23mm x 21mm BGA form factor. It is designed to be used in an environment which requires a rugged, small form factor. By eliminating the SD socket and soldering the SDChip™ directly onto the system board, shock and vibration resistance is greatly increased as compared to the standard SD card & socket arrangement.

The Cactus Technologies Industrial Grade SD Card & SDChip™ products use high quality flash memory from well known vendors, such as Samsung Corporation. In addition, it include an on-drive intelligent controller that manages interface protocols, data storage and retrieval as well as ECC, defect handling & diagnostics, power management, and clock control. The controller's firmware is upgradeable, thus allowing feature enhancements and firmware updates in the field.

1.1. Supported Standards

Cactus Technologies SD products are fully electrically compatible with the following specification:

- SD Card Association Physical Layer Specification, Versions 1.01, 1.1 and 2.0

1.2. Product Features

Cactus Technologies Industrial SD products contain a high level, intelligent controller. This intelligent controller provides many capabilities including the following:

- SD Card register and command set handling.
- Management of erasing and programming the flash memory independent of the host system.
- Sophisticated defect managing capabilities (similar to magnetic disk drives).
- Sophisticated system for error recovery using powerful error correction code (ECC).
- Intelligent power management for low power operation.

1.2.1. Host and Technology Independence

Cactus Technologies Industrial SD products utilize a 512-byte sector which is the same as that in an IDE magnetic disk drive. To write or read a sector (or multiple sectors), the host computer software simply issues a Read or Write command to the drive and then waits for the command to complete. The host system does not need to know the details of how the flash memory is erased, programmed or read, as this is all managed by the built-in controller in the drive. Also, with the intelligent on-board controller, the host system software will not need to be updated to match new flash technologies. Thus, systems that support the Cactus Technologies Industrial SD products today will continue to work with future Cactus Technologies Industrial SD products built with new flash technology without having to update or change host software.

1.2.2. Defect and Error Management

Cactus Technologies Industrial SD products contain a sophisticated defect and error management system similar to those found in magnetic disk drives. The defect management is completely transparent to the host and does not consume any user data space.

The bit error rate for Cactus Technologies Industrial SD products is much lower than that of magnetic disk drives. When a read error does occur, the drive has sophisticated ECC to recover the data.

These defect and error management systems, coupled with the solid-state construction, give Cactus Technologies Industrial SD products extremely high reliability.

1.2.3. Intelligent Power Management

Cactus Technologies Industrial SD products employ sophisticated power management algorithms to conserve power. Upon completion of a command, the drive will automatically enter sleep mode if no further commands are received. In most situations, the drive will be in sleep mode except when the host is accessing it, thus conserving power.

When the drive is in sleep mode, any command issued to the drive will cause it to exit sleep and respond.

1.2.4. Power Supply Requirements

Cactus Technologies Industrial SD products are single voltage products and operate at a voltage range of 3.30 volts $\pm 10\%$.

2. Product Specifications

For all the following specifications, values are defined at ambient temperature and nominal supply voltage unless otherwise stated.

2.1. System Environmental Specifications

Table 2-1. Environmental Specifications

		Cactus SD Card & SDChip™
Temperature	Operating:	-25° C to +85° C (Standard) -45° C to +90° C (Extended)
Humidity	Operating & Non-Operating:	8% to 95%, non-condensing
Acoustic Noise		0 dB
Vibration	Operating & Non-Operating:	15 G peak to peak maximum
Shock	Operating & Non-Operating:	50G max. operating; 1,000 G max. non-operating
Altitude (relative to sea level)	Operating & Non-Operating:	100,000 feet maximum

2.2. System Power Requirements

Table 2-2. Power Requirements

		Cactus SD Card & SDChip™
DC Input Voltage (VCC) 100 mV max. ripple (p-p)		3.3V ±10%
(Maximum Average Value) See Notes.	Sleep:	180 µA
	Reading:	40 mA
	Writing:	60 mA

NOTES: All values quoted are typical values at room temperature and nominal supply voltage unless otherwise stated.

Sleep mode is specified under the condition that all drive inputs are static CMOS levels and in a “Not Busy” operating state and with the input clock stopped.

2.3. System Performance

All performance timings are typical values under normal operating conditions and assuming the drive controller is in the default (i.e., fastest) mode.

Table 2-3. Performance

Start Up Times	Reset to ready:	200 msec typical
Read Transfer Rate		22 MBytes/sec
Write Transfer Rate		16 MBytes/sec
Controller Overhead		2 msec maximum

2.4. System Reliability

Table 2-4. Reliability

MTBF (@ 25°C)	> 4,000,000 hours
Data Reliability	< 1 non-recoverable error in 10 ¹⁵ bits READ
Endurance:	> 2,000,000 erase/program cycles

2.5. Physical Specifications

The following sections provide the physical specifications for Cactus Technologies Industrial SD products.

2.5.1. SD Card Physical Specifications

The Cactus SD Card has the form factor or 24mm x 32mm x2.1mm.

Refer to Figure 2-2.1 for Cactus SD Card mechanical specifications.

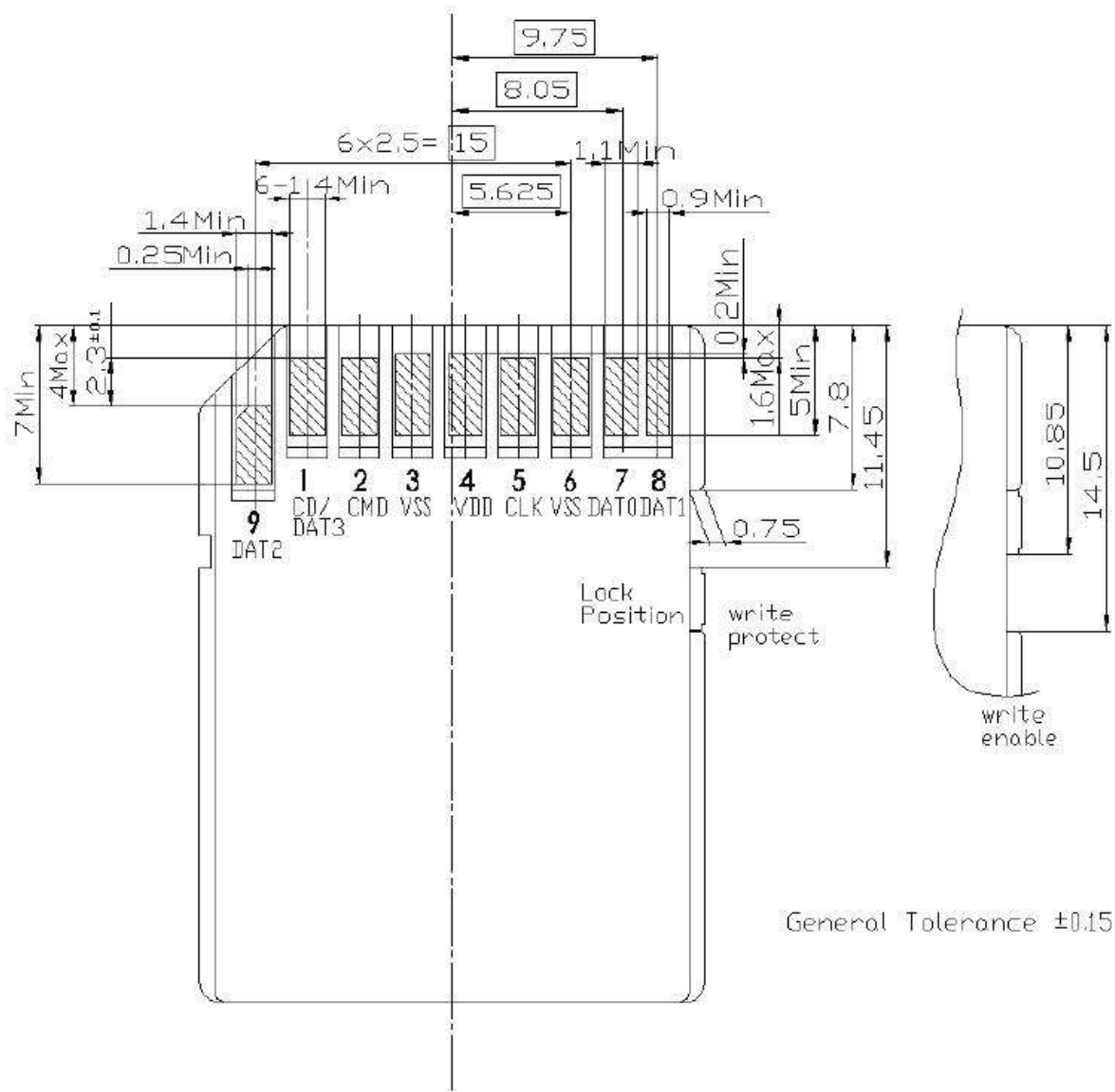

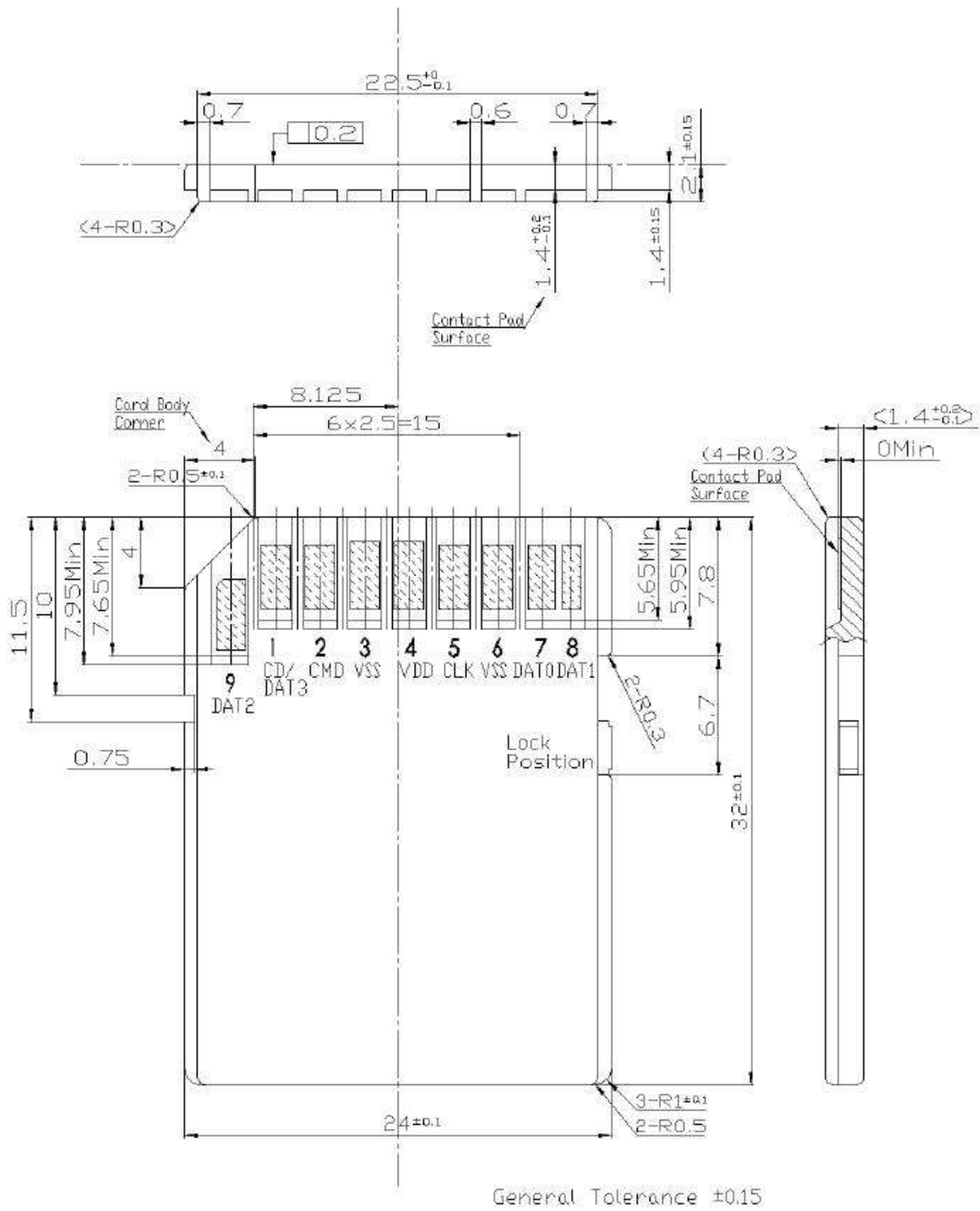

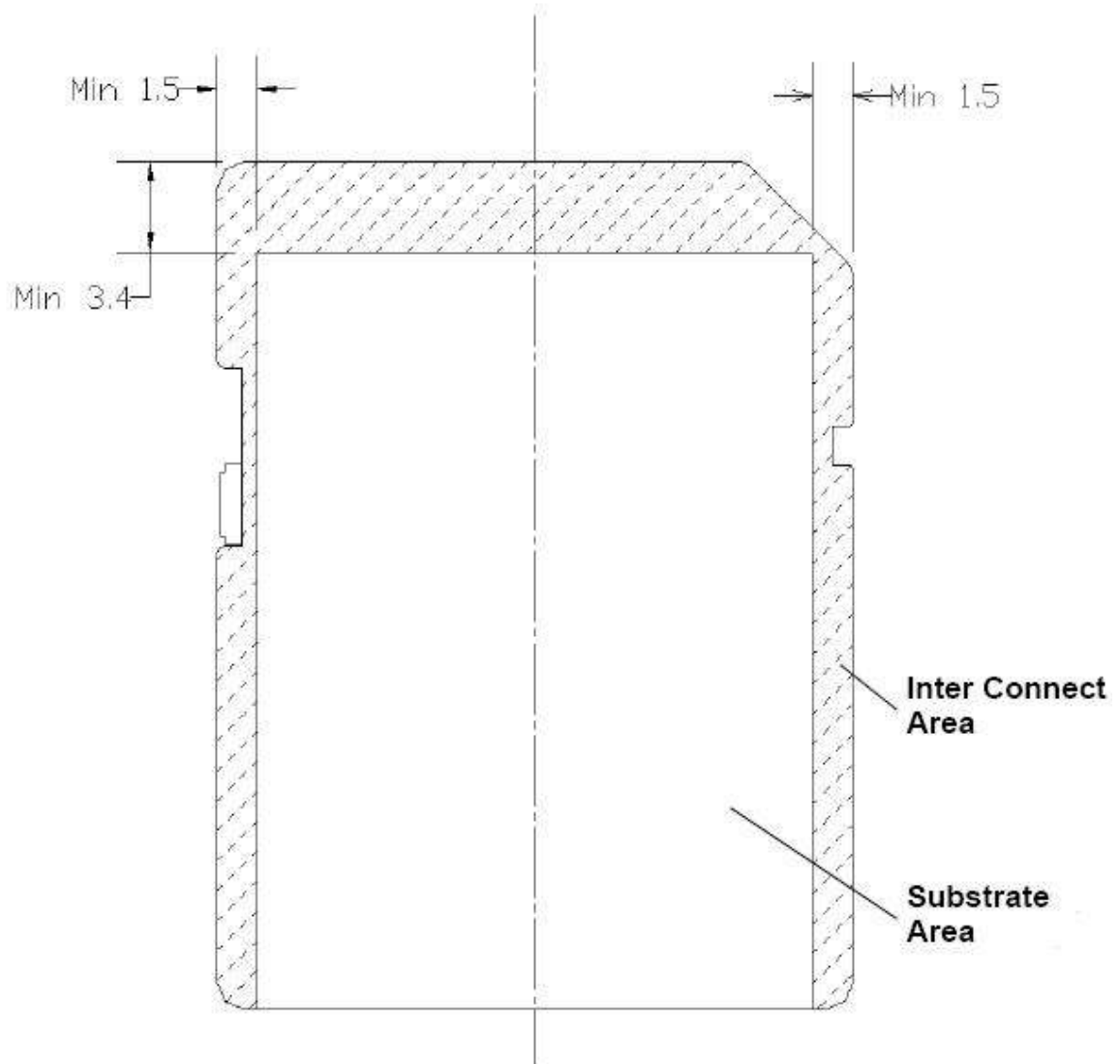
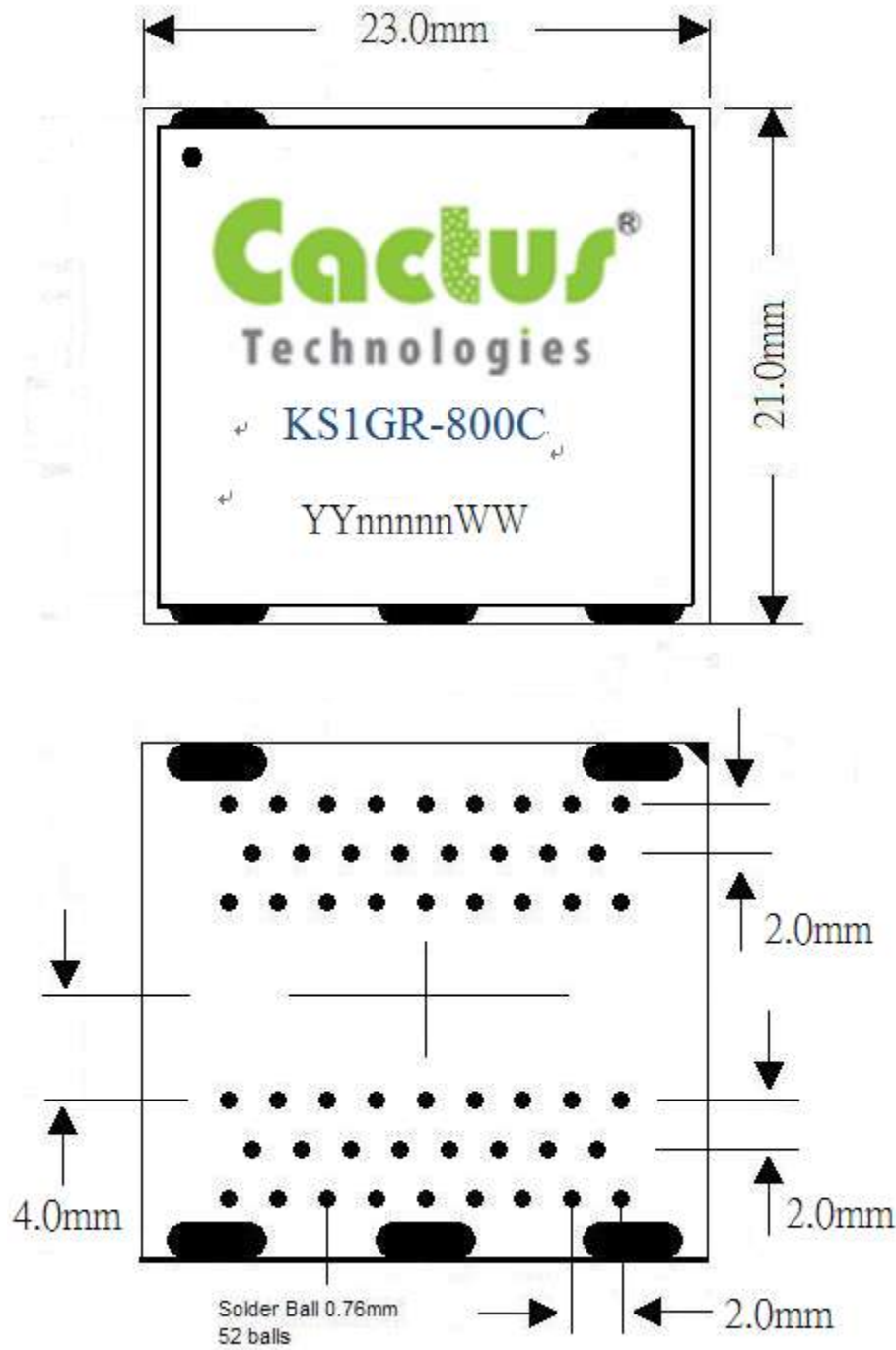
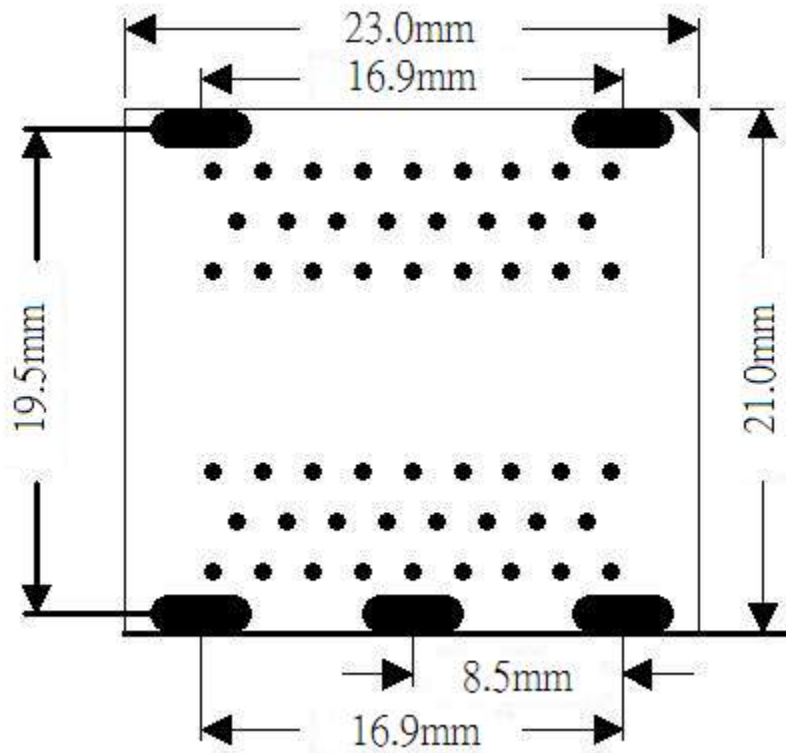

Figure 2-1. SD Card Mechanical Specifications

2.5.2. SDChip™ Physical Specifications





Encap plus PCB Thickness : 1.85mm +/-0.18mm

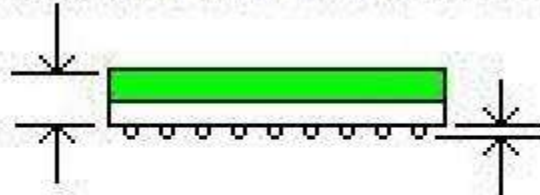

Ball Height

0.66mm +/-0.06mm

2.6. Capacity Specifications

The following sections provide capacity specifications for Cactus Technologies SD Card products.

Table 2-5 shows the specific capacity for the various models.

Table 2-5. Model Capacities

Capacity	Capacity (formatted)	Total Sectors
128MB	127,139,840 bytes	248,320
256MB	255,852,544 bytes	499,712
512MB	513,277,952 bytes	1,002,496
1GB	1,023,934,464 bytes	1,999,872
2GB	2,057,830,400 bytes	4,019,200
4GB	4,125,622,272 bytes	8,057,86
8GB*	8,269,594,624 bytes	16,151,552

Note: 8GB capacity available in SD Card products only.

3.Interface Description

The following sections provide detailed information on the Cactus Technologies Industrial SD Card interface.

3.1. SD Card Pin Assignments and Pin Type

The signal/pin assignments are listed in Table 3-6. Signals are active high unless otherwise specified.

Table 3-6. SD Card Pin Assignments and Pin Type

Pin #	SD Mode			SPI Mode		
	Signal Name	Pin Type ¹	Description	Signal Name	Pin Type	Description
1	CD/DAT3 ²	I/O/PP ³	Card Detect/ Data Line bit 3	CSN	I	Chip Select (active low)
2	CMD	PP	Command/Response	SDI	I	Serial Data In
3	VSS1	S	Supply Ground	VSS	S	Supply Ground
4	VDD	S	Supply Power	VDD	S	Supply Power
5	CLK	I	Clock	SCLK	I	Serial Clock
6	VSS2	S	Supply Ground	VSS2	S	Supply Ground
7	DAT2	I/O/PP	Data Line bit 2	SDO	O	Serial Data Out
8	DAT1	I/O/PP	Data Line bit 1	RSV		Reserved
9	DAT0	I/O/PP	Data Line bit 0	RSV		Reserved

1) S: Power; I: Input; O: output; PP: Bidirectional

2) DAT[1:3] are inputs on power up.

3) After power up, this pin is input with 50Kohm pullup. The host can disconnect the pullup by issuing a SET_CLR_CARD_DETECT command.

3.2. SDChip™ Ball Assignment

The following diagram shows the signal assignment for the BGA package:

SD chip balls assignment

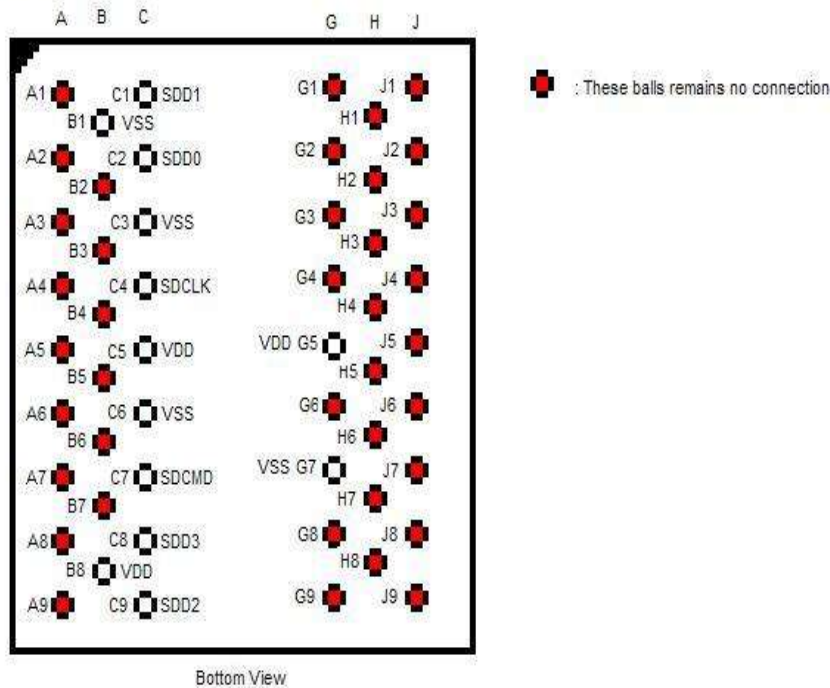

3.3. Signal Description

Table 3-7 describes the I/O signals. Signals whose source is the host are designated as inputs while signals that the SD Card sources are outputs. The SD Card logic levels conform to those specified in the *SDA Physical Layer Specification, version 1.1*.

Table 3-7. Signal Description

Signal Name	Dir.	Description
CD/DAT3/SDD3 (SD mode)	I/O/ PP	This pin is an input with 50Kohm pullup at power up time and can be used for card detection or SPI mode selection. For regular data transfer, the host should disconnect the pullup by issuing a SET_CLR_CARD_DETECT command to the card.
CSN (SPI mode)	I	In SPI mode, this is an input for chip select.
CMD/SDCMD	PP	This pin is used by the host to send command to the card and is used by the card to send response back to the host.
SDI	I	In SPI mode, this is serial data input to the card.
CLK/SDCLK	I	This is clock input to the card.

Signal Name	Dir.	Description
DAT0/SDD0	I/O/ PP	This pin is input on power up. It will function as a data line once the host has issued a SET_BUS_WIDTH command.
SDO	O	In SPI mode, this pin is serial data out from the card.
DAT1/SDD1, DAT2/SDD2	I/O/ PP	These pins are inputs on power up. They will function as data lines once the host has issued a SET_BUS_WIDTH command.

3.4. Bus Protocol

The Cactus SD products bus protocol is compliant to *SDA Physical Layer Specifications, Version 1.01, 1.1 and 2.0*. Please refer to those documents for details about bus protocol and timing.

3.5. Electrical Specification

The following table defines all D.C. Characteristics for the Cactus SD products. Unless otherwise stated, conditions are:

$$V_{cc} = 3.3V \pm 10\%$$

$$T_a = -45^{\circ}C \text{ to } 90^{\circ}C$$

3.5.1. Absolute Maximum Ratings

Parameter	Symbol	MIN	MAX	Units
Storage Temperature	T _s	-65	+150	°C
Operating Temperature	T _A	-45	+90	°C
V _{cc} with respect to GND	V _{cc}	-0.3	6.5	V

3.5.2. DC Characteristics

Parameter	Symbol	MIN	MAX	Units
Input Voltage	V _{in}	-0.5	V _{cc} + 0.5	V
Output Voltage	V _{out}	-0.3	V _{cc} + 0.3	V
Input Leakage Current	I _{LI}	-10	10	uA
Output Leakage Current	I _{LO}	-10	10	uA
Input/Output Capacitance	C _I /C _O		10	pF

Parameter	Symbol	MIN	MAX	Units
Operating Current	I_{CC}			mA
Sleep Mode			0.2	
@50MHz			80	

3.5.3. AC Characteristics

3.5.3.1. Bus Timing

Please refer to *Sections 6.7 and 6.8* of the *SDA Physical Layer Specifications, Version 1.1* for bus timing specifications for default mode and high speed mode.

4. Register Table

This section describes the values in the SD registers of Cactus SD products.

4.1. Operation Condition Register (OCR)

This 32-bit register stores the VDD voltage profile of the card. In addition, bit 31 is a status bit which is set to '1' if the card power up procedure has completed. When bit 31 is set, bit 30 will be valid and identifies whether the card is a Standard ('0') or High Capacity ('1') SD card.

OCR bit	VDD range	Value
[6:0]	Reserved	000 0000 b
[7]	1.65V – 1.95V	0 b
[14:8]	2.0V – 2.6V	000 0000 b
[23:15]	2.7V – 3.6V	1 1111 1111 b
[29:24]	Reserved	00 0000 b
[30]	Card capacity status	
[31]	Card power status	

4.2. Card Identification Register (CID)

This 128-bit register contains the identification information used during the card identification phase.

CID bit	Width	Name	Value	Field
[127:120]	8	Manufacturer ID	63h	MID
[119:104]	16	OEM/Application ID	CZ	OID
[103:64]	40	Product Name	Cactu	PNM
[63:56]	8	Product Revision	2	PRV
[55:24]	32	Product Serial Number	XXXXXXXXXh	PSN

CID bit	Width	Name	Value	Field
[23:20]	4	Reserved	----	----
[19:8]	12	Manufacturing Date	MM YY	MDT
[7:1]	7	CRC7 check sum	XXXXXXXb	CRC
[0]	1	Not used, always '1'	1	----

4.3. Relative Card Address Register (RCA)

This 16-bit register stores the card address assigned by the host during the card identification phase. The default value is 0x0000. In SD mode, the value in this register is generated by a random number generator as per SDA specifications.

4.4. Card Specific Data Register (CSD)

This 128-bit register provides information on how to access the card content. It defines such information as the data format, error correction type, maximum access time, data transfer speed, etc. The various fields in the register differ depending on whether the card is high capacity (4GB or more) or standard capacity (2GB or less).

4.4.1. High Capacity Card CSD

CSD bit	Width	Name	Field	Value	Note
[127:126]	2	CSD Structure	CSD_STRUCTURE	01 b	v.2.0
[125:120]	6	Reserved	---	---	---
[119:112]	8	Data read access time 1	TAAC	0E h	1ms (*3)
[111:104]	8	Data read access time 2	NSAC	00 h	(*3)
[103:96]	8	Max. data transfer rate	TRAN_SPEED	32 h	25MHz
[95:84]	12	Card command classes	CCC	5F5h	*1
[83:80]	4	Max. read data block length	READ_BL_LEN	9 h	512bytes(*3)
[79]	1	Partial block read allowed	READ_BL_PARTIAL	0 b	Not Supported (*3)

CSD bit	Width	Name	Field	Value	Note
[78]	1	Write block misalignment	WRITE_BLK_MISALIGN	0 b	Not Supported (*3)
[77]	1	Read block misalignment	READ_BLK_MISALIGN	0 b	Not Supported (*3)
[76]	1	DSR implemented	DSR_IMP	0 b	Not supported (*3)
[75:70]	6	Reserved	---	000000b	---
[69:48]	22	Device size	C_SIZE	*2	*2
[47]	1	Reserved	---	0 b	---
[46]	1	Erase single block enable	ERASE_BLK_EN	1 b	Allowed (*3)
[45:39]	7	Erase sector size	SECTOR_SIZE	7Fh	64KB (*3)
[38:32]	7	Write protect group size	WP_GRP_SIZE	00h	(*3)
[31]	1	Write protect group enable	WP_GRP_ENABLE	0 b	Not Supported (*3)
[30:29]	2	Reserved	---	---	---
[28:26]	3	Write speed factor	R2W_FACTOR	010 b	4X (*3)
[25:22]	4	Max. write data block length	WRITE_BL_LEN	9 h	512bytes (*3)
[21]	1	Partial block write allowed	WRITE_BL_PARTIAL	0 b	Not Supported (*3)
[20:16]	5	Reserved	---	---	---
[15]	1	File format group	FILE_FORMAT_GRP	0 b	HD FAT (*3)
[14]	1	Copy flag	COPY	0 b	Not copied
[13]	1	Permanent write protection	PERM_WRITE_PROTECT	0 b	Not protected
[12]	1	Temporary write protection	TMP_WRITE_PROTECT	0 b	Not protected
[11:10]	2	File format	FILE_FORMAT	00 b	HD FAT (*3)
[9:8]	2	ECC code	ECC	00 b	None
[7:1]	7	CRC	CRC	---	---

CSD bit	Width	Name	Field	Value	Note
[0]	1	Not used	---	1 b	---

1. Support command class 0,2,4,5,6,7,8,10. Not supported command class 1,3.
2. Varies according to memory type.
3. These parameters are set to fixed values to allow compatibility to v1.0 CSD.
4. Varies according to memory type.

4.4.2. Standard Capacity Card CSD

CSD bit	Width	Name	Field	Value	Note
[127:126]	2	CSD Structure	CSD_STRUCTURE	00 b	v1.0-v1.1 v2.0 (<= 2GB)
[125:120]	6	Reserved	---	---	---
[119:112]	8	Data read access time 1	TAAC	7F h	80ms
[111:104]	8	Data read access time 2	NSAC	FF h	25.5K clocks
[103:96]	8	Max. data transfer rate	TRAN_SPEED	32 h	25MHz
[95:84]	12	Card command classes	CCC	5F5h	*1
[83:80]	4	Max. read data block length	READ_BLK_LEN	9 h	512bytes
[79]	1	Partial block read allowed	READ_BLK_PARTIAL	1 b	Supported
[78]	1	Write block misalignment	WRITE_BLK_MISALIGN	1 b	Supported
[77]	1	Read block misalignment	READ_BLK_MISALIGN	1 b	Supported
[76]	1	DSR implemented	DSR_IMP	0 b	Not supported
[75:74]	2	Reserved	---	--	---
[73:62]	12	Device size	C_SIZE	*2	*2
[61:59]	3	Max. R_curr @ Vdd min	VDD_R_CURR_MIN	101 b	35mA
[58:56]	3	Max R_curr @ Vdd max	VDD_R_CURR_MAX	101 b	45mA
[55:53]	3	Max. W_curr @ Vdd min	VDD_W_CURR_MIN	101 b	35mA
[52:50]	3	Max W_curr @ Vdd max	VDD_W_CURR_MAX	101 b	45mA

CSD bit	Width	Name	Field	Value	Note
[49:47]	3	Device size multiplier	C_SIZE_MULT	*2	*2
[46]	1	Erase single block enable	ERASE_BLK_EN	0 b	Not Allowed
[45:39]	7	Erase sector size	SECTOR_SIZE	(*3)	(*3)
[38:32]	7	Write protect group size	WP_GRP_SIZE	(*4)	(*4)
[31]	1	Write protect group enable	WP_GRP_ENABLE	1 b	Supported
[30:29]	2	Reserved	---	---	---
[28:26]	3	Write speed factor	R2W_FACTOR	101 b	32X
[25:22]	4	Max. write data block length	WRITE_BL_LEN	9 h	512bytes
[21]	1	Partial block write allowed	WRITE_BL_PARTIAL	1 b	Supported
[20:16]	5	Reserved	---	---	---
[15]	1	File format group	FILE_FORMAT_GRP	0 b	HD FAT
[14]	1	Copy flag	COPY	0 b	Not copied
[13]	1	Permanent write protection	PERM_WRITE_PROTECT	0 b	Not protected
[12]	1	Temporary write protection	TMP_WRITE_PROTECT	0 b	Not protected
[11:10]	2	File format	FILE_FORMAT	00 b	HD FAT
[9:8]	2	ECC code	ECC	00 b	None
[7:1]	7	CRC	CRC	---	---
[0]	1	Not used	---	1 b	---

1. Support command class 0,2,4,5,6,7,8,10. Not supported command class 1,3.
2. Varies according to memory type.
3. Varies according to memory type.
4. Varies according to memory type.

4.5. SD Card Configuration Register (SCR)

This 64-bit register provides additional information about special features configured into the card.

SCR bit	Width	Name	Field	Value	Note
[63:60]	4	SCR structure	SCR_STRUCTURE	0000 b	v1.0-2.0
[59:56]	4	SD Card spec. version	SD_SPEC	0010 b	v2.0
[55]	1	Data status after erase	DATA_STAT_AFTER_ERASE	0 b	zero after erase
[54:52]	3	SD security support	SD_SECURITY	011 b	Security Protocol 2.0
[51:48]	4	DAT bus width support	SD_BUS_WIDTH	0101 b	Support 1 / 4 bits
[47:32]	16	Reserved	---	---	---
[31:0]	32	Reserved	---	---	---

Appendix A. Ordering Information

Model KSXRZ-800C

Where: X is drive capacities:

128M ----- 128MB
256M ----- 256MB
512M ----- 512MB
1G ----- 1GB
2G ----- 2GB
4G ----- 4GB
8G ----- 8GB

Where Z is temperature:

Blank ----- Standard temperature (-25° C to +85° C)
I ----- Extended temperature (-45° C to +90° C)

Where C is form factor:

Blank ----- Standard SD Card
C ----- SDChip™

Example:

(1) 512MB SD -----KS512MR-800
(2) 1GB SD Extended Temp ----- KS1GRI-800
(3) 2GB SD -----KS2GR-800
(4) 128MB SD Extended Temp ----- KS128MRI-800
(5) 1GB SDChip™ ----- KS1GR-800C

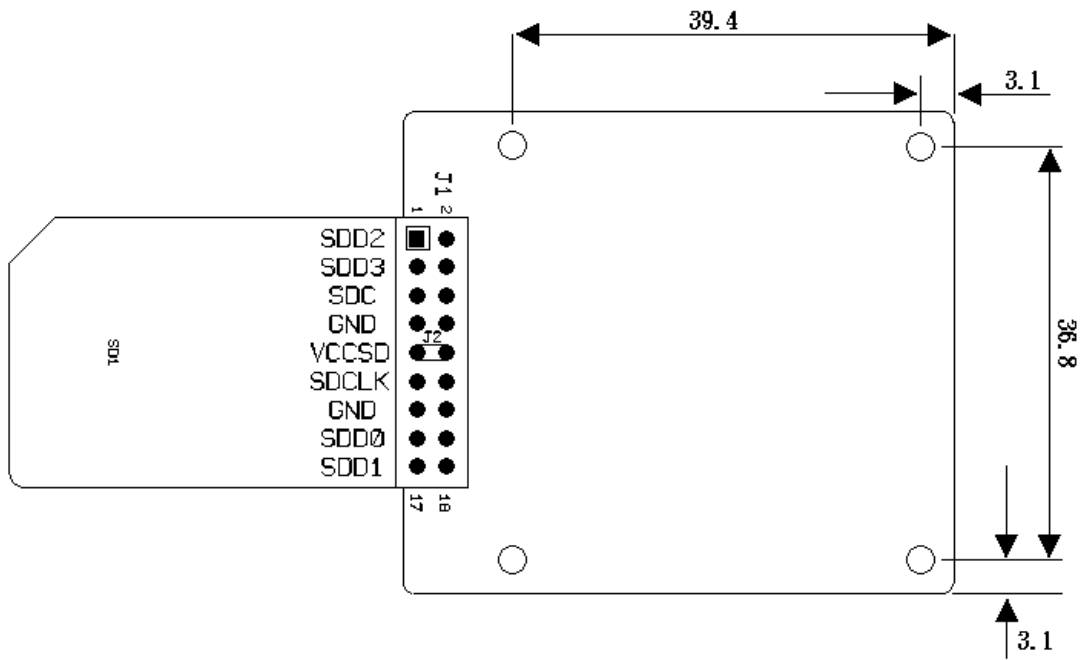

General tolerances: $\pm 0.15\text{mm}$

Please contact your local Cactus sales representative to obtain samples of this adapter.

Appendix C. Technical Support Services

C.1. Direct Cactus Technical Support

Cactus Technologies, Limited
Suite C, 15/F, Capital Trade Center
62 Tsun Yip Street, Kwun Tong
Kowloon, Hong Kong

Tel: (852) 27972261

Fax: (852) 27973777

Email: tech@cactus-tech.com

Appendix D.Cactus Worldwide Sales Offices

Cactus Technologies, Limited

Suite C, 15/F, Capital Trade Center

62 Tsun Yip Street, Kwun Tong

Kowloon, Hong Kong

Tel: (852) 27972261

Fax: (852) 27973777

Email: sales@cactus-tech.com

Appendix E.Limited Warranty

I. WARRANTY STATEMENT

Cactus Technologies warrants its Industrial Grade products only to be free of any defects in materials or workmanship that would prevent them from functioning properly for seven years from the date of purchase. This express warranty is extended by Cactus Technologies Limited

II. GENERAL PROVISIONS

This warranty sets forth the full extent of Cactus's responsibilities regarding the Cactus Industrial Grade SD Card products. In satisfaction of its obligations hereunder, Cactus, at its sole option, will either repair, replace or refund the purchase price of the product.

NOTWITHSTANDING ANYTHING ELSE IN THIS LIMITED WARRANTY OR OTHERWISE, THE EXPRESS WARRANTIES AND OBLIGATIONS OF SELLER AS SET FORTH IN THIS LIMITED WARRANTY, ARE IN LIEU OF, AND BUYER EXPRESSLY WAIVES ALL OTHER OBLIGATIONS, GUARANTIES AND WARRANTIES OF ANY KIND, WHETHER EXPRESS OR IMPLIED, INCLUDING WITHOUT LIMITATION, ANY IMPLIED WARRANTY OF MERCHANTABILITY OR FITNESS FOR A PARTICULAR PURPOSE OR INFRINGEMENT, TOGETHER WITH ANY LIABILITY OF SELLER UNDER ANY CONTRACT, NEGLIGENCE, STRICT LIABILITY OR OTHER LEGAL OR EQUITABLE THEORY FOR LOSS OF USE, REVENUE, OR PROFIT OR OTHER INCIDENTAL OR CONSEQUENTIAL DAMAGES, INCLUDING WITHOUT LIMITATION PHYSICAL INJURY OR DEATH, PROPERTY DAMAGE, LOST DATA, OR COSTS OF PROCUREMENT OF SUBSTITUTE GOODS, TECHNOLOGY OR SERVICES. IN NO EVENT SHALL THE SELLER BE LIABLE FOR DAMAGES IN EXCESS OF THE PURCHASE PRICE OF THE PRODUCT, ARISING OUT OF THE USE OR INABILITY TO USE SUCH PRODUCT, TO THE FULL EXTENT SUCH MAY BE DISCLAIMED BY LAW.

Cactus's products are not warranted to operate without failure. Accordingly, in any use of products in life support systems or other applications where failure could cause injury or loss of life, the products should only be incorporated in systems designed with appropriate redundancy, fault tolerant or back-up features.

III. WHAT THIS WARRANTY COVERS

For products found to be defective within five years of purchase, Cactus Technologies will have the option of repairing or replacing the defective product, if the following conditions are met:

- A. The defective product is returned to Cactus Technologies for failure analysis as soon as possible after the failure occurs.
- B. An incident drive filled out by the user, explaining the conditions of usage and the nature of the failure, accompanies each returned defective product.
- C. No evidence is found of abuse or operation of products not in accordance with the published specifications, or of exceeding storage or maximum ratings or operating conditions.

All failing products returned to Cactus Technologies under the provisions of this limited warranty shall be tested to the product's functional and performance specifications. Upon confirmation of failure, each product will be analyzed, by whatever means necessary, to determine the root cause of failure. If the root cause of failure is found to be not covered by the above provisions, then the product will be returned to the customer with a report indicating why the failure was not covered under the warranty.

This warranty does not cover defects, malfunctions, performance failures or damages to the unit resulting from use in other than its normal and customary manner, misuse, accident or neglect; or improper alterations or repairs.

Cactus Technologies reserves the right to repair or replace, at its discretion, any product returned by its customers, even if such product is not covered under warranty, but is under no obligation to do so.

Cactus Technologies may, at its discretion, ship repaired or rebuilt products identified in the same way as new products, provided such drives meet or exceed the same published specifications as new products. Concurrently, Cactus Technologies also reserves the right to market any products, whether new, repaired, or rebuilt, under different specifications and product designations if such products do not meet the original product's specifications.

IV. RECEIVING WARRANTY SERVICE

According to Cactus's warranty procedure, defective product should be returned only with prior authorization from Cactus Technologies Limited. Please contact Cactus's Customer Service department with the following information: product model number and description, nature of defect, conditions of use, proof of purchase and purchase date. If approved, Cactus Technologies will issue a Return Material Authorization or Product Repair Authorization number. Ship the defective product to:

Cactus Technologies, Limited
Suite C, 15/F, Capital Trade Center
62 Tsun Yip Street, Kwun Tong
Kowloon, Hong Kong