

SMPS STACKED CAPACITORS

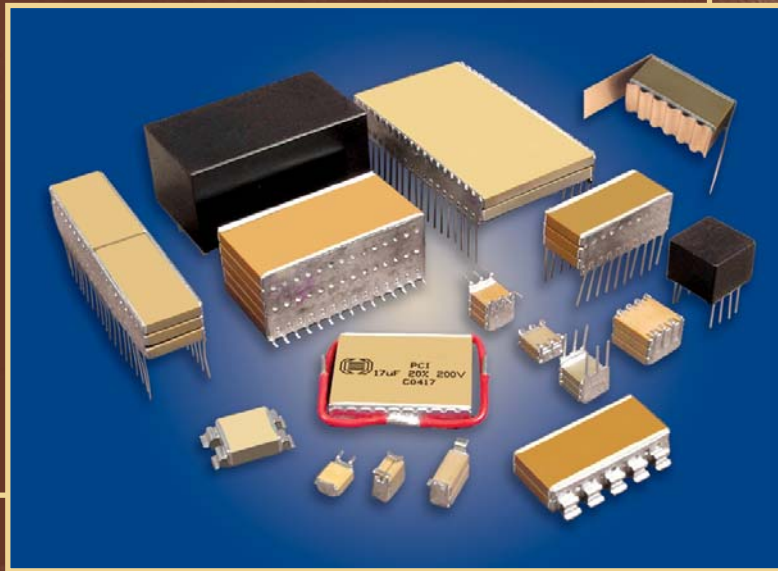

CATALOG 1001

TABLE OF CONTENTS

MIL-PRF-49470 SPECIFICATION	2
DSCC DRAWING 88011 (NPO STACKED CAPACITORS).....	2
MIL-PRF-49470 STANDARD PROFILE.....	3-4
MIL-PRF-49470 LOW PROFILE.....	5
MIL-PRF-49470 ELECTRICAL AND PERFORMANCE CHARACTERISTICS	6
MIL-PRF-49470 FREQUENCY RESPONSE CURVES.....	6
AVAILABLE TEST ROUTINES	7
SOLDERING RECOMMENDATIONS	7
STACKED CAPACITORS	8-9
HIGH VOLTAGE STACKED CAPACITORS.....	10
POWER-STACK CAPACITORS	11
LOW PROFILE 'S' LEAD CAPACITORS AND SPECIFICATIONS	12-13
HIGH FREQUENCY – HIGH POWER CAPACITORS.....	14
INTERDIGITATED STACKED CAPACITORS.....	15
CUSTOM PRODUCTS AND OTHER PRESIDIO CATALOGS	16

MIL-PRF-49470

NOTE: DSCC DRAWING 87106 HAS BEEN CANCELLED
www.dsccl.com/downloads/MilSpec/DscclDwg/87106.pdf

Mil-PRF-49470 capacitors are preferred over DSCC-DWG-87106 capacitors. The Mil-PRF-49470 specification was developed as part of a cooperative effort between the US Military, NASA and the SMPS suppliers to produce a robust replacement for the DSCC drawing. The military specification product provides additional quality assurance provisions that are NOT required by the DSCC drawing. Two product levels are offered in Mil-PRF-49470: the standard "B" level, suitable for standard Class "H" military applications, and the high reliability "T" level, suitable for Class "K" space level applications. Some of the benefits of the Mil-PRF-49470 product over the 87106 product include: Formal qualification process (QPL established); Mil-STD-790 compliance; DSCC audits; routine qualification maintenance testing (ie., life testing); Group A percent defective allowed (PDA) specified; prohibits mixing of chips from different production lots within a single SMPS stack lot.

Mil-PRF-49470 "T" Level product is recommended for all high reliability applications. Mil-PRF-49470 "T" level product requires in-process inspections and additional Group A and B screening inspections that are not part of the normal "B" level flow: In-process screening that includes non-destructive internal examination (chip level) and destructive physical analysis (chip level); Group A destructive physical analysis (finished stack level); Group B lot specific humidity, steady-state, low voltage (lot sample test); and Group B lot specific thermal shock and life test (lot sample test).

DSCC DRAWING 88011 (NPO STACKED CAPACITORS)

Popular selected values of this version of NPO are being qualified. For more information, contact Presidio Components at **858-578-9390** or visit our website at www.presidiocomponents.com.

49470 DIMENSIONS

49470 Case Code	C ± .025 in. (± .64 mm)	D inches (mm)		E (max) inches (mm)	Number of Leads Per Side
		Min	Max		
1	.450 (11.43)	1.950 (49.53)	2.075 (52.71)	.500 (12.70)	20
2	.800 (20.32)	1.450 (36.83)	1.535 (38.99)	.870 (22.10)	15
3	.450 (11.43)	.950 (24.13)	1.075 (27.31)	.500 (12.70)	10
4	.400 (10.16)	.350 (8.89)	.425 (10.80)	.440 (11.18)	4
5	.250 (6.35)	.224 (5.69)	.275 (6.99)	.300 (7.62)	3
6	1.250 (31.75)	1.950 (49.53)	2.075 (52.71)	1.350 (34.29)	20

49470 STANDARD PROFILE

49470 Lead Symbol (Last Digit of P/N)	Lead Style	Stack Height Profile (Dimension A)	Formed Lead Height inches (mm)
N	N (straight)	Standard	N/A
L	L (formed)	Standard	.070 ± .010 (1.78 ± 0.25)
M	L (formed)	Standard	.045 ± .010 (1.14 ± 0.25)
J	J (formed)	Standard	.070 ± .010 (1.78 ± 0.25)
K	J (formed)	Standard	.045 ± .010 (1.14 ± 0.25)

49470/87106/88011 LEAD STYLE AND DIMENSIONS

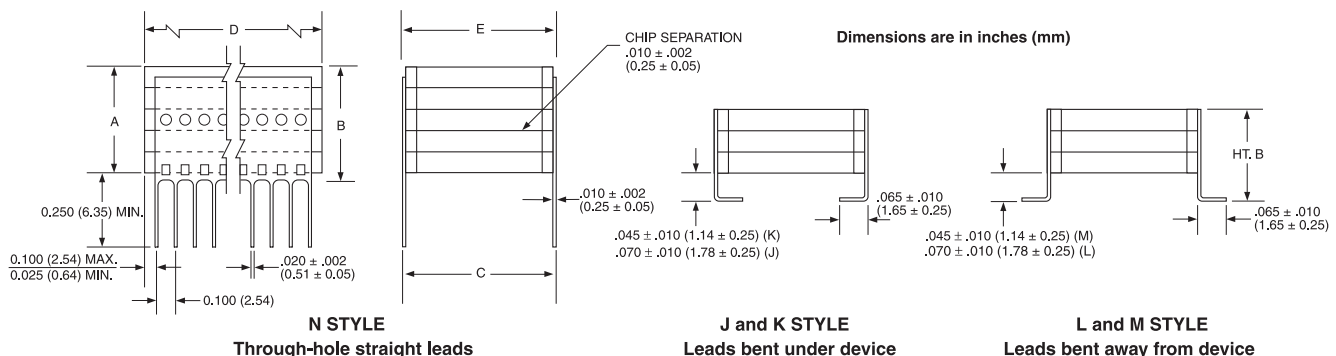

7169 Construction Court, San Diego, CA 92121 USA • Tel: 858-578-9390 • Fax: 800-538-3880 or 858-578-6225
www.presidiocomponents.com • info@presidiocomponents.com

MIL-PRF-49470 STANDARD PROFILE

M for 20% tol.

MIL-PRF-49470 (change K to M for 20% tolerance)	Cap µF	Case	Height A inches (mm)	Cap Tol. 10%	Presidio Part Number (change K to M for 20% tolerance)	Cross Reference from 87106			
						87106-xxx N-Lead		87106-xxx J-Lead	
						K Tol.	M Tol.	K Tol.	M Tol.
50V									
M49470 X 01 105 K A *	1.0	5	.120 (3.05)	10%	HR S 1 01 BX 105 K 2 * 3	001	002	241	242
M49470 X 01 125 K A *	1.2	5	.120 (3.05)	10%	HR S 1 01 BX 125 K 2 * 3	003	004	243	244
M49470 X 01 155 K A *	1.5	5	.240 (6.10)	10%	HR S 2 01 BX 155 K 2 * 3	005	006	245	246
M49470 X 01 185 K A *	1.8	5	.240 (6.10)	10%	HR S 2 01 BX 185 K 2 * 3	007	008	247	248
M49470 X 01 225 K A *	2.2	5	.240 (6.10)	10%	HR S 2 01 BX 225 K 2 * 3	009	010	249	250
M49470 X 01 275 K A *	2.7	5	.360 (9.14)	10%	HR S 3 01 BX 275 K 2 * 3	011	012	251	252
M49470 X 01 335 K A *	3.3	5	.360 (9.14)	10%	HR S 3 01 BX 335 K 2 * 3	013	014	253	254
M49470 X 01 395 K A *	3.9	5	.480 (12.19)	10%	HR S 4 01 BX 395 K 2 * 3	015	016	255	256
M49470 X 01 475 K A *	4.7	5	.480 (12.19)	10%	HR S 4 01 BX 475 K 2 * 3	017	018	257	258
M49470 X 01 565 K A *	5.6	5	.650 (16.51)	10%	HR S 5 01 BX 565 K 2 * 3	019	020	259	260
M49470 X 01 685 K A *	6.8	4	.360 (9.14)	10%	HR S 3 05 BX 685 K 2 * 4	223	224	261	262
M49470 X 01 825 K A *	8.2	4	.360 (9.14)	10%	HR S 3 05 BX 825 K 2 * 4	021	022	263	264
M49470 X 01 106 K A *	10	4	.480 (12.19)	10%	HR S 4 05 BX 106 K 2 * 4	023	024	265	266
M49470 X 01 126 K A *	12	4	.480 (12.19)	10%	HR S 4 05 BX 126 K 2 * 4	025	026	267	268
M49470 X 01 156 K A *	15	4	.650 (16.51)	10%	HR S 5 05 BX 156 K 2 * 4	027	028	269	270
M49470 X 01 186 K A *	18	3	.240 (6.10)	10%	HR S 2 13 BX 186 K 2 * 10	029	030	271	272
M49470 X 01 226 K A *	22	3	.360 (9.14)	10%	HR S 3 13 BX 226 K 2 * 10	031	032	273	274
M49470 X 01 276 K A *	27	3	.360 (9.14)	10%	HR S 3 13 BX 276 K 2 * 10	033	034	275	276
M49470 X 01 336 K A *	33	3	.360 (9.14)	10%	HR S 3 13 BX 336 K 2 * 10	035	036	277	278
M49470 X 01 396 K A *	39	3	.480 (12.19)	10%	HR S 4 13 BX 396 K 2 * 10	037	038	279	280
M49470 X 01 476 K A *	47	3	.650 (16.51)	10%	HR S 5 13 BX 476 K 2 * 10	039	040	281	282
M49470 X 01 566 K A *	56	1	.360 (9.14)	10%	HR S 3 19 BX 566 K 2 * 20	225	226	283	284
M49470 X 01 686 K A *	68	1	.480 (12.19)	10%	HR S 4 19 BX 686 K 2 * 20	041	042	285	286
M49470 X 01 826 K A *	82	1	.480 (12.19)	10%	HR S 4 19 BX 826 K 2 * 20	043	044	287	288
M49470 X 01 107 K A *	100	1	.650 (16.51)	10%	HR S 5 19 BX 107 K 2 * 20	045	046	289	290
M49470 X 01 127 K A *	120	2	.480 (12.19)	10%	HR S 4 15 BX 127 K 2 * 15	227	228	291	292
M49470 X 01 157 K A *	150	2	.650 (16.51)	10%	HR S 5 15 BX 157 K 2 * 15	047	048	293	294
M49470 X 01 187 K A *	180	6	.480 (12.19)	10%	HR S 4 18 BX 187 K 2 * 20	049	050	295	296
M49470 X 01 227 K A *	220	6	.480 (12.19)	10%	HR S 4 18 BX 227 K 2 * 20	051	052	297	298
M49470 X 01 277 K A *	270	6	.650 (16.51)	10%	HR S 5 18 BX 277 K 2 * 20	053	054	299	300
100V						K Tol.	M Tol.	K Tol.	M Tol.
M49470 X 01 684 K B *	.68	5	.120 (3.05)	10%	HR S 1 01 BX 684 K 3 * 3	055	056	301	302
M49470 X 01 824 K B *	.82	5	.240 (6.10)	10%	HR S 2 01 BX 824 K 3 * 3	057	058	303	304
M49470 X 01 105 K B *	1.0	5	.240 (6.10)	10%	HR S 2 01 BX 105 K 3 * 3	059	060	305	306
M49470 X 01 125 K B *	1.2	5	.240 (6.10)	10%	HR S 2 01 BX 125 K 3 * 3	061	062	307	308
M49470 X 01 155 K B *	1.5	5	.360 (9.14)	10%	HR S 3 01 BX 155 K 3 * 3	063	063	309	310
M49470 X 01 185 K B *	1.8	5	.360 (9.14)	10%	HR S 3 01 BX 185 K 3 * 3	065	066	311	312
M49470 X 01 225 K B *	2.2	5	.480 (12.19)	10%	HR S 4 01 BX 225 K 3 * 3	067	068	313	314
M49470 X 01 275 K B *	2.7	5	.480 (12.19)	10%	HR S 4 01 BX 275 K 3 * 3	069	070	315	316
M49470 X 01 335 K B *	3.3	5	.650 (16.51)	10%	HR S 5 01 BX 335 K 3 * 3	071	072	317	318
M49470 X 01 395 K B *	3.9	4	.360 (9.14)	10%	HR S 3 05 BX 395 K 3 * 4	073	074	319	320
M49470 X 01 475 K B *	4.7	4	.360 (9.14)	10%	HR S 3 05 BX 475 K 3 * 4	075	076	321	322
M49470 X 01 565 K B *	5.6	4	.480 (12.19)	10%	HR S 4 05 BX 565 K 3 * 4	077	078	323	324
M49470 X 01 685 K B *	6.8	4	.480 (12.19)	10%	HR S 4 05 BX 685 K 3 * 4	079	080	325	326
M49470 X 01 825 K B *	8.2	4	.650 (16.51)	10%	HR S 5 05 BX 825 K 3 * 4	081	082	327	328
M49470 X 01 106 K B *	10	3	.240 (6.10)	10%	HR S 2 13 BX 106 K 3 * 10	229	230	329	330
M49470 X 01 126 K B *	12	3	.240 (6.10)	10%	HR S 2 13 BX 126 K 3 * 10	083	084	331	332
M49470 X 01 156 K B *	15	3	.360 (9.14)	10%	HR S 3 13 BX 156 K 3 * 10	085	086	333	334
M49470 X 01 186 K B *	18	3	.360 (9.14)	10%	HR S 3 13 BX 186 K 3 * 10	087	088	335	336
M49470 X 01 226 K B *	22	3	.480 (12.19)	10%	HR S 4 13 BX 226 K 3 * 10	089	090	337	338
M49470 X 01 276 K B *	27	3	.650 (16.51)	10%	HR S 5 13 BX 276 K 3 * 10	091	092	339	340
M49470 X 01 336 K B *	33	1	.360 (9.14)	10%	HR S 3 19 BX 336 K 3 * 20	093	094	341	342
M49470 X 01 396 K B *	39	1	.480 (12.19)	10%	HR S 4 19 BX 396 K 3 * 20	095	096	343	344
M49470 X 01 476 K B *	47	1	.480 (12.19)	10%	HR S 4 19 BX 476 K 3 * 20	097	098	345	346
M49470 X 01 566 K B *	56	1	.650 (16.51)	10%	HR S 5 19 BX 566 K 3 * 20	099	100	347	348
M49470 X 01 686 K B *	68	2	.480 (12.19)	10%	HR S 4 15 BX 686 K 3 * 15	101	102	349	350
M49470 X 01 826 K B *	82	2	.650 (16.51)	10%	HR S 5 15 BX 826 K 3 * 15	103	104	351	352
M49470 X 01 107 K B *	100	6	.360 (9.14)	10%	HR S 3 18 BX 107 K 3 * 20	105	106	353	354
M49470 X 01 127 K B *	120	6	.360 (9.14)	10%	HR S 3 18 BX 127 K 3 * 20	107	108	355	356
M49470 X 01 157 K B *	150	6	.480 (12.19)	10%	HR S 4 18 BX 157 K 3 * 20	109	110	357	358
M49470 X 01 187 K B *	180	6	.650 (16.51)	10%	HR S 5 18 BX 187 K 3 * 20	111	112	359	360

Note 1: Asterisk (*) refers to lead style N through K; consult factory or DSCC website for qualification status.

Note 2: Parts can also be ordered with 20% cap tolerance; include "M" in the Presidio part number. Example: HR S 1 01 BX 105 M 2 * 3

Note 3: BP 5% tolerance available; consult factory

MIL-PRF-49470 P/N

M49470	X	01	105	K	A	N
Performance Specification Indicating MIL-PRF-49470 (for T Level parts substitute "T" for "M" in the above)	Characteristic (1.2.1.1)	Performance Specification Sheet Number Indicating MIL-PRF-49470/1	Capacitance Value (1.2.1.2)	J = 5% K = 10% M = 20% Capacitance Tolerance (1.2.1.3)	Rated Voltage (1.2.1.4)	Lead Configuration (1.2.1.5)

Call for 5% tol. (BP only)



MIL-PRF-49470 STANDARD PROFILE

M for 20% tol.

Cross Reference from 87106

MIL-PRF-49470 (change K to M for 20% tolerance)	Cap µF	Case	Height A inches (mm)	Cap Tol. 10%	Presidio Part Number (change K to M for 20% tolerance)	Cross Reference from 87106			
						87106-xxx N-Lead		87106-xxx J-Lead	
						K Tol.	M Tol.	K Tol.	M Tol.
200V									
M49470 R 01 474 K C *	.47	5	.240 (6.10)	10%	HR S 2 01 BR 474 K 4 * 3	113	114	361	362
M49470 R 01 564 K C *	.56	5	.240 (6.10)	10%	HR S 2 01 BR 564 K 4 * 3	115	116	363	364
M49470 R 01 684 K C *	.68	5	.360 (9.14)	10%	HR S 3 01 BR 684 K 4 * 3	117	118	365	366
M49470 R 01 824 K C *	.82	5	.360 (9.14)	10%	HR S 3 01 BR 824 K 4 * 3	119	120	367	368
M49470 R 01 105 K C *	1.0	5	.480 (12.19)	10%	HR S 4 01 BR 105 K 4 * 3	121	122	369	370
M49470 R 01 125 K C *	1.2	5	.480 (12.19)	10%	HR S 4 01 BR 125 K 4 * 3	123	124	371	372
M49470 R 01 155 K C *	1.5	5	.650 (16.51)	10%	HR S 5 01 BR 155 K 4 * 3	125	126	373	374
M49470 R 01 185 K C *	1.8	4	.360 (9.14)	10%	HR S 3 05 BR 185 K 4 * 4	127	128	375	376
M49470 R 01 225 K C *	2.2	4	.360 (9.14)	10%	HR S 3 05 BR 225 K 4 * 4	129	130	377	378
M49470 R 01 275 K C *	2.7	4	.480 (12.19)	10%	HR S 4 05 BR 275 K 4 * 4	131	132	379	380
M49470 R 01 335 K C *	3.3	4	.480 (12.19)	10%	HR S 4 05 BR 335 K 4 * 4	133	134	381	382
M49470 R 01 395 K C *	3.9	4	.650 (16.51)	10%	HR S 5 05 BR 395 K 4 * 4	135	136	383	384
M49470 R 01 475 K C *	4.7	3	.240 (6.10)	10%	HR S 2 13 BR 475 K 4 * 10	137	138	385	386
M49470 R 01 565 K C *	5.6	3	.240 (6.10)	10%	HR S 2 13 BR 565 K 4 * 10	139	140	387	388
M49470 R 01 685 K C *	6.8	3	.360 (9.14)	10%	HR S 3 13 BR 685 K 4 * 10	141	142	389	390
M49470 R 01 825 K C *	8.2	3	.360 (9.14)	10%	HR S 3 13 BR 825 K 4 * 10	143	144	391	392
M49470 R 01 106 K C *	10	3	.480 (12.19)	10%	HR S 4 13 BR 106 K 4 * 10	145	146	393	394
M49470 R 01 126 K C *	12	3	.650 (16.51)	10%	HR S 5 13 BR 126 K 4 * 10	147	148	395	396
M49470 R 01 156 K C *	15	1	.360 (9.14)	10%	HR S 3 19 BR 156 K 4 * 20	149	150	397	398
M49470 R 01 186 K C *	18	1	.480 (12.19)	10%	HR S 4 19 BR 186 K 4 * 20	151	152	399	400
M49470 R 01 226 K C *	22	1	.650 (16.51)	10%	HR S 5 19 BR 226 K 4 * 20	153	154	401	402
M49470 R 01 276 K C *	27	1	.650 (16.51)	10%	HR S 5 19 BR 276 K 4 * 20	155	156	403	404
M49470 R 01 336 K C *	33	2	.480 (12.19)	10%	HR S 4 15 BR 336 K 4 * 15	157	158	405	406
M49470 R 01 396 K C *	39	2	.650 (16.51)	10%	HR S 4 15 BR 396 K 4 * 15	159	160	407	408
M49470 R 01 476 K C *	47	6	.240 (6.10)	10%	HR S 2 18 BR 476 K 4 * 20	161	162	409	410
M49470 R 01 566 K C *	56	6	.360 (9.14)	10%	HR S 3 18 BR 566 K 4 * 20	163	164	411	412
M49470 R 01 686 K C *	68	6	.360 (9.14)	10%	HR S 3 18 BR 686 K 4 * 20	165	166	413	414
M49470 R 01 826 K C *	82	6	.480 (12.19)	10%	HR S 4 18 BR 826 K 4 * 20	167	168	415	416
M49470 R 01 107 K C *	100	6	.650 (16.51)	10%	HR S 5 18 BR 107 K 4 * 20	169	170	417	418
M49470 R 01 127 K C *	120	6	.650 (16.51)	10%	HR S 5 18 BR 127 K 4 * 20	171	172	419	420
500V						K Tol.	M Tol.	K Tol.	M Tol.
M49470 Q 01 154 K E *	.15	5	.120 (3.05)	10%	HR S 1 01 BQ 154 K 6 * 3	173	174	421	422
M49470 Q 01 184 K E *	.18	5	.240 (6.10)	10%	HR S 2 01 BQ 184 K 6 * 3	175	176	423	424
M49470 Q 01 224 K E *	.22	5	.240 (6.10)	10%	HR S 2 01 BQ 224 K 6 * 3	177	178	425	426
M49470 Q 01 274 K E *	.27	5	.240 (6.10)	10%	HR S 2 01 BQ 274 K 6 * 3	179	180	427	428
M49470 Q 01 334 K E *	.33	5	.360 (9.14)	10%	HR S 3 01 BQ 334 K 6 * 3	181	182	429	430
M49470 Q 01 394 K E *	.39	5	.360 (9.14)	10%	HR S 3 01 BQ 394 K 6 * 3	183	184	431	432
M49470 Q 01 474 K E *	.47	5	.360 (9.14)	10%	HR S 3 01 BQ 474 K 6 * 3	185	186	433	434
M49470 Q 01 564 K E *	.56	5	.480 (12.19)	10%	HR S 4 01 BQ 564 K 6 * 3	187	188	435	436
M49470 Q 01 684 K E *	.68	5	.650 (16.51)	10%	HR S 5 01 BQ 684 K 6 * 3	189	190	437	438
M49470 Q 01 824 K E *	.82	4	.360 (9.14)	10%	HR S 3 05 BQ 824 K 6 * 4	231	232	439	440
M49470 Q 01 105 K E *	1.0	4	.360 (9.14)	10%	HR S 3 05 BQ 105 K 6 * 4	191	192	441	442
M49470 Q 01 125 K E *	1.2	4	.360 (9.14)	10%	HR S 3 05 BQ 125 K 6 * 4	193	194	443	444
M49470 Q 01 155 K E *	1.5	4	.480 (12.19)	10%	HR S 4 05 BQ 155 K 6 * 4	195	196	445	446
M49470 Q 01 185 K E *	1.8	4	.650 (16.51)	10%	HR S 5 05 BQ 185 K 6 * 4	197	198	447	448
M49470 Q 01 225 K E *	2.2	3	.240 (6.10)	10%	HR S 2 13 BQ 225 K 6 * 10	233	234	449	450
M49470 Q 01 275 K E *	2.7	3	.360 (9.14)	10%	HR S 3 13 BQ 275 K 6 * 10	199	200	451	452
M49470 Q 01 335 K E *	3.3	3	.360 (9.14)	10%	HR S 3 13 BQ 335 K 6 * 10	201	202	453	454
M49470 Q 01 395 K E *	3.9	3	.360 (9.14)	10%	HR S 3 13 BQ 395 K 6 * 10	203	204	455	456
M49470 Q 01 475 K E *	4.7	3	.480 (12.19)	10%	HR S 4 13 BQ 475 K 6 * 10	205	206	457	458
M49470 Q 01 565 K E *	5.6	3	.650 (16.51)	10%	HR S 5 13 BQ 565 K 6 * 10	207	208	459	460
M49470 Q 01 685 K E *	6.8	1	.480 (12.19)	10%	HR S 4 19 BQ 685 K 6 * 20	235	236	461	462
M49470 Q 01 825 K E *	8.2	1	.480 (12.19)	10%	HR S 4 19 BQ 825 K 6 * 20	209	210	463	464
M49470 Q 01 106 K E *	10	1	.480 (12.19)	10%	HR S 4 19 BQ 106 K 6 * 20	211	212	465	466
M49470 Q 01 126 K E *	12	1	.650 (16.51)	10%	HR S 5 19 BQ 126 K 6 * 20	213	214	467	468
M49470 Q 01 156 K E *	15	2	.650 (16.51)	10%	HR S 5 15 BQ 156 K 6 * 15	237	238	469	470
M49470 Q 01 186 K E *	18	2	.650 (16.51)	10%	HR S 4 15 BQ 186 K 6 * 15	215	216	471	472
M49470 Q 01 226 K E *	22	6	.360 (9.14)	10%	HR S 3 18 BQ 226 K 6 * 20	239	240	473	474
M49470 Q 01 276 K E *	27	6	.360 (9.14)	10%	HR S 3 18 BQ 276 K 6 * 20	217	218	475	476
M49470 Q 01 336 K E *	33	6	.480 (12.19)	10%	HR S 4 18 BQ 336 K 6 * 20	219	220	477	478
M49470 Q 01 396 K E *	39	6	.650 (16.51)	10%	HR S 4 18 BQ 396 K 6 * 20	221	222	479	480

Note 1: Asterisk (*) refers to lead style N through K; consult factory or DSCC website for qualification status.

Note 2: Parts can also be ordered with 20% cap tolerance; include "M" in the Presidio part number. Example: HR S 2 01 BX 105 M 2 * 3

Note 3: BP available; consult factory

MIL-PRF-49470 P/N

M49470

X

01

684

K

B

N

Performance Specification Indicating MIL-PRF-49470 (for T Level parts substitute "T" for "M" in the above)

Characteristic (1.2.1.1)

Performance Specification Sheet Number Indicating MIL-PRF-49470/1

Capacitance Value (1.2.1.2)

J = 5%
K = 10%
M = 20%
Capacitance Tolerance (1.2.1.3)

Rated Voltage (1.2.1.4)

Lead Configuration (1.2.1.5)

Call for 5% tol. (BP only)



PRESIDIO COMPONENTS, INC.

7169 Construction Court, San Diego, CA 92121 USA • Tel: 858-578-9390 • Fax: 800-538-3880 or 858-578-6225
www.presidiocomponents.com • info@presidiocomponents.com

MIL-PRF-49470 LOW PROFILE REDUCED HEIGHT-LARGER CASE SIZE

M for 20% tol.

MIL-PRF-49470 (change K to M for 20% tol.)	Cap µF	Case	Height A inches (mm)	Cap Tol. 10%	Presidio Part No. (change K to M for 20% tol.)
50V					
M49470 X 01 475 K A *	4.7	4	.240 (6.10)	10%	HR S 205 BX 475 K 2 * 4
M49470 X 01 565 K A *	5.6	4	.240 (6.10)	10%	HR S 205 BX 565 K 2 * 4
M49470 X 01 156 K A *	15	3	.240 (6.10)	10%	HR S 213 BX 156 K 2 * 10
M49470 X 01 476 K A *	47	2	.240 (6.10)	10%	HR S 215 BX 476 K 2 * 15
M49470 X 01 566 K A *	56	2	.240 (6.10)	10%	HR S 215 BX 566 K 2 * 15
M49470 X 01 686 K A *	68	2	.360 (9.14)	10%	HR S 315 BX 686 K 2 * 15
M49470 X 01 826 K A *	82	2	.360 (9.14)	10%	HR S 315 BX 826 K 2 * 15
M49470 X 01 107 K A *	100	2	.480 (12.19)	10%	HR S 415 BX 107 K 2 * 15

MIL-PRF-49470 (change K to M for 20% tol.)	Cap µF	Case	Height A inches (mm)	Cap Tol. 10%	Presidio Part No. (change K to M for 20% tol.)
100V					
M49470 X 01 225 K B *	2.2	4	.240 (6.10)	10%	HR S 205 BX 225 K 3 * 4
M49470 X 01 335 K B *	3.3	4	.240 (6.10)	10%	HR S 205 BX 335 K 3 * 4
M49470 X 01 825 K B *	8.2	3	.240 (6.10)	10%	HR S 213 BX 825 K 3 * 10
M49470 X 01 276 K B *	27	2	.240 (6.10)	10%	HR S 215 BX 276 K 3 * 15
M49470 X 01 336 K B *	33	2	.240 (6.10)	10%	HR S 215 BX 336 K 3 * 15
M49470 X 01 396 K B *	39	2	.360 (9.14)	10%	HR S 315 BX 396 K 3 * 15
M49470 X 01 476 K B *	47	2	.360 (9.14)	10%	HR S 315 BX 476 K 3 * 15

MIL-PRF-49470 (change K to M for 20% tol.)	Cap µF	Case	Height A inches (mm)	Cap Tol. 10%	Presidio Part No. (change K to M for 20% tol.)
200V					
M49470 R 01 105 K C *	1.0	4	.120 (3.05)	10%	HR S 105 BR 105 K 4 * 4
M49470 R 01 125 K C *	1.2	4	.240 (6.10)	10%	HR S 205 BR 125 K 4 * 4
M49470 R 01 155 K C *	1.5	4	.240 (6.10)	10%	HR S 205 BR 155 K 4 * 4
M49470 R 01 395 K C *	3.9	3	.240 (6.10)	10%	HR S 213 BR 395 K 4 * 10
M49470 R 01 126 K C *	12	2	.240 (6.10)	10%	HR S 215 BR 126 K 4 * 15
M49470 R 01 156 K C *	15	2	.240 (6.10)	10%	HR S 215 BR 156 K 4 * 15
M49470 R 01 186 K C *	18	2	.360 (9.14)	10%	HR S 315 BR 186 K 4 * 15
M49470 R 01 226 K C *	22	2	.360 (9.14)	10%	HR S 315 BR 226 K 4 * 15
M49470 R 01 276 K C *	27	2	.480 (12.19)	10%	HR S 415 BR 276 K 4 * 15

MIL-PRF-49470 (change K to M for 20% tol.)	Cap µF	Case	Height A inches (mm)	Cap Tol. 10%	Presidio Part No. (change K to M for 20% tol.)
500V					
M49470 Q 01 564 K E *	.56	4	.240 (6.10)	10%	HR S 205 BQ 564 K 6 * 4
M49470 Q 01 684 K E *	.68	4	.240 (6.10)	10%	HR S 205 BQ 684 K 6 * 4
M49470 Q 01 185 K E *	1.8	3	.240 (6.10)	10%	HR S 213 BQ 185 K 6 * 10
M49470 Q 01 565 K E *	5.6	2	.240 (6.10)	10%	HR S 215 BQ 565 K 6 * 15
M49470 Q 01 685 K E *	6.8	2	.240 (6.10)	10%	HR S 215 BQ 685 K 6 * 15
M49470 Q 01 825 K E *	8.2	2	.360 (9.14)	10%	HR S 315 BQ 825 K 6 * 15
M49470 Q 01 106 K E *	10	2	.360 (9.14)	10%	HR S 315 BQ 106 K 6 * 15
M49470 Q 01 126 K E *	12	2	.480 (12.19)	10%	HR S 415 BQ 126 K 6 * 15

For these parts low profile indicates the height has been reduced by using a larger case code and reducing the number of chips per stack.

Asterisk (*) refers to lead style A – F; consult factory or DSCC website for qualification status.

49470 LOW PROFILE

49470 Lead Symbol (Last Digit of P/N)	Lead Style	Stack Height Profile (Dimension A)	Formed Lead Height inches (mm)
A	N (straight)	Low	N/A
B	L (formed)	Low	.070 ± .010 (1.78 ± 0.25)
D	L (formed)	Low	.045 ± .010 (1.14 ± 0.25)
C	J (formed)	Low	.070 ± .010 (1.78 ± 0.25)
F	J (formed)	Low	.045 ± .010 (1.14 ± 0.25)

49470 DIMENSIONS

49470 Case Code	C ± .025 in. (± .64 mm)	D inches (mm)		E (max) inches (mm)	Number of Leads Per Side
		Min	Max		
1	.450 (11.43)	1.950 (49.53)	2.075 (52.71)	.500 (12.70)	20
2	.800 (20.32)	1.450 (36.83)	1.535 (38.99)	.870 (22.10)	15
3	.450 (11.43)	.950 (24.13)	1.075 (27.31)	.500 (12.70)	10
4	.400 (10.16)	.350 (8.89)	.425 (10.80)	.440 (11.18)	4
5	.250 (6.35)	.224 (5.69)	.275 (6.99)	.300 (7.62)	3
6	1.250 (31.75)	1.950 (49.53)	2.075 (52.71)	1.350 (34.29)	20

49470/87106/88011 LEAD STYLE AND DIMENSIONS

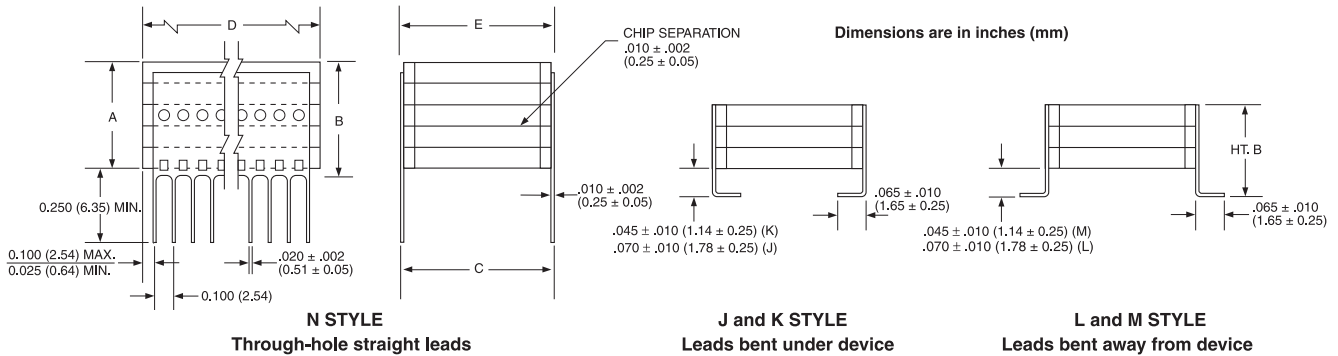

MIL-PRF-49470 P/N

M49470	X	01	475	K	A	A
Performance Specification Indicating MIL-PRF-49470 (for T Level parts substitute "T" for "M" in the above)	Characteristic (1.2.1.1)	Performance Specification Sheet Number Indicating MIL-PRF-49470/1	Capacitance Value (1.2.1.2)	J = 5% K = 10% M = 20% Capacitance Tolerance (1.2.1.3)	Rated Voltage (1.2.1.4)	Lead Configuration (1.2.1.5)

Call for 5% tol. (BP only)



PRESIDIO COMPONENTS, INC.

7169 Construction Court, San Diego, CA 92121 USA • Tel: 858-578-9390 • Fax: 800-538-3880 or 858-578-6225
www.presidiocomponents.com • info@presidiocomponents.com

MIL-PRF-49470 ELECTRICAL AND PERFORMANCE CHARACTERISTICS (ALL CHARACTERISTICS AND TEST METHODS IAW MIL-PRF-49470)

ELECTRICAL CHARACTERISTICS

Rated Voltage: 50/100/200/500 volts.

Temperature Coefficient:

Dielectric Type	Bias = 0 Volt	Bias = Rated Voltage
BP All Voltages	±30PPM	±30PPM
BX 50/100V	±15%	+15, -25%
BR 200V	±15%	+15, -40%
BQ 500V	±15%	+15, -50%

Capacitance: Measured at 1.0 volt (open circuit) and 1KHz. See tables on pages 2 through 5.

Capacitance Tolerance: J = ±5%, K = ±10%, M = ±20%.

Dissipation Factor: When tested at 1.0 volt (open circuit) and 1KHz, BP characteristic shall be .15% maximum and BX/BR/BQ characteristic shall be 2.5% maximum.

Dielectric Withstanding Voltage: Dielectric withstanding voltage will be tested at 250% of rated voltage except for 500V rated parts which will be tested at 150% of rated voltage.

Insulation Resistance:

At +25°C, rated voltage: $10^{11} \Omega$ or 1000 MΩ-μF, whichever is less.

At +125°C, rated voltage: $10^{10} \Omega$ or 100 MΩ-μF, whichever is less.

PERFORMANCE CHARACTERISTICS AND TEST METHODS (M49470 PART NUMBERS)

Operating Temperature Range: The operating temperature range is -55°C to +125°C.

Thermal Shock: All parts are cycled between -55°C and +125°C, 5 times.

Voltage Conditioning: All parts are tested for 96 hours at 125°C and 200% of rated voltage except 500V rated parts are tested at 120% of rated voltage. The overall percent defective allowed (PDA) is 10%.

Solderability: Meets Mil-STD-202 and J-STD-001 requirements.

Resistance to Soldering Heat: Parts withstand 260°C for 10 seconds with no degradation in electrical performance or lead attachment.

Terminal Strength: Leads will withstand 5 pounds (4 pounds for case code 5) of applied force without rupturing.

Moisture Resistance: Every 3 months, parts are tested for 20 cycles at 90% RH and between -10°C to +65°C. Bias is applied during the first 10 cycles.

Life: Parts are tested for 1000 hours at +125°C and 200% of rated voltage except 500V rated parts shall be tested at 120% of rated voltage.

Barometric Pressure: Parts will operate at rated voltage (80% of rated voltage for 500 volt parts) at reduced pressure up to 100,000 feet.

Shock, Specified Pulse: Parts remain operational during and after impacts of 100 G's.

Vibration: Parts remain operational during and after operating in high vibration environments of up to 20 G's.

Marking: Marking shall be in accordance with Mil-STD-1285 and Mil-PRF-49470. Minimum marking will be "JB", manufacturer's code (PCI), capacitance and tolerance, and date code. Full marking will be included on the package.

Cage Code 60212: Presidio Components, Inc.

ADDITIONAL REQUIREMENTS (T49470 PART NUMBERS)

Ultrasonic Imaging: All parts are imaged during in-process testing to remove voids and delaminations IAW EIA 469.

Destructive Physical Analysis: A sample of chips is examined prior to assembly for defects in the microstructure. As part of Group A, an additional sample is examined for cracks or assembly defects.

Thermal Shock: Prior to voltage conditioning, all parts are cycled between -55°C and +125°C, 20 times. Prior to life test sample pieces receive 100 cycles under conditions outlined above.

Voltage Conditioning: All parts are tested for 168 - 264 hours at 125°C and 200% of rated voltage except 500V rated parts are tested at 120% of rated voltage. The overall percent defective allowed (PDA) is 5% for case codes 4 and 5 and 8% for all other case codes. The PDA in the last 48 hours of voltage conditioning is .5% for case codes 4 and 5, and 1% for all other case codes, or 1 piece whichever is greater.

Life: For qualification, parts are tested for 4000 hours at +125°C and 200% of rated voltage except 500V rated parts shall be tested at 120% of rated voltage. For each lot, 12 pieces are tested for a 1000 hours under conditions outlined above.

Humidity, Steady State, Low Voltage: Six pieces are tested from each lot at 1.3 volts, 85% RH and 85°C, to ensure the absence of low voltage failure mechanisms. These mechanisms include microcracking.

Marking: Parts will be marked as M49470 parts except "JB" is replaced with "JT".

MIL-PRF-49470 FREQUENCY RESPONSE CURVES

DOWNLOADABLE GRAPHS IN PDF FORMAT

VISIT our library
of Power Supply Capacitors
Frequency Response Curves

LOG ON TO PRESIDIO'S WEBSITE AT:
www.presidiocomponents.com/curves

All graphs in PDF format for easy viewing.

10μF, 50 VOLT M49470X01106_A_
PRESIDIO PN S405BX106_2_4

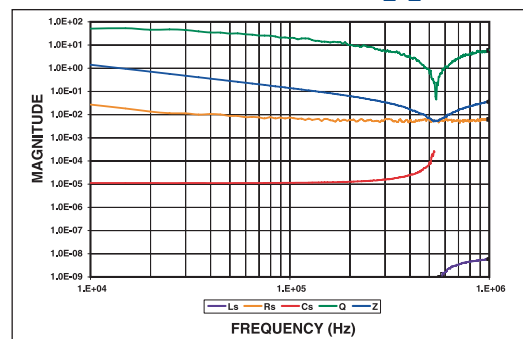

 PRESIDIO COMPONENTS, INC.

7169 Construction Court, San Diego, CA 92121 USA • Tel: 858-578-9390 • Fax: 800-538-3880 or 858-578-6225
www.presidiocomponents.com • info@presidiocomponents.com

PRESIDIO COMPONENTS, INC.
AVAILABLE TEST ROUTINES

	Presidio Standard (All Test Methods IAW Mil-PRF-49470)			DSCC Standard	
	Commercial	“HR” Stack	“SR” Stack	Mil-PRF-49470 B Level	Mil-PRF-49470 T Level
Description	For Commercial Applications	Similar to Mil-PRF-49470 B Level or Per SCD	Similar to Mil-PRF-49470 T Level or Per SCD	High Reliability Military	High Reliability Space
Chip DPA	Yes Presidio Internal Requirement	Yes Presidio Internal Requirement	Yes Presidio Internal Requirement	Yes Presidio Internal Requirement	Yes Specification Requirement
Ultrasonic Imaging C-Scan	Not Required	Not Required or per SCD	Optional	Not Required	Required
Thermal Shock As Part Of Group A	Not Required	5 Cycles or per SCD	20 Cycles or per SCD	5 Cycles	20 Cycles
Voltage Conditioning (Duration)	Not Required	8 Hours Min. or per SCD	168 - 264 Hours	96 Hours	168 - 264 Hours
Visual/100% Electrical (Cap/DF/IR/DWV)	Yes	Yes	Yes	Yes	Yes
IR 125°C	Not Required	Optional	Optional	Required	Required
Stack DPA	Not Required	Not Required or per SCD	Optional	Not Required	Required
Life Test	Not Required	Optional	Optional	Not Required on Lot Basis	Yes - Includes 100 Thermal Shock Cycles
Humidity, Steady State, Low Voltage	Not Required	Not Required or per SCD	Optional	Not Required	Yes
Mil-STD-790 Approved Facility	Yes	Yes	Yes	Yes	Yes

SOLDERING RECOMMENDATIONS FOR CERAMIC STACKED CAPACITORS

The following are general recommendations for soldering of ceramic stacked capacitors. In general, Presidio Components recommends against hand soldering for this type of large ceramic device. However, if hand soldering cannot be avoided, it should be done with care to avoid thermally cracking the parts. Soldering of these parts to the circuit board, if done in a careless manner, is the most likely source of reliability problems.

PREHEATING AND MOUNTING. For reflow soldering, the parts should be preheated to within 50°C - 60°C of the reflow temperature, or as close as is practical. A convection-style reflow oven with nitrogen is ideal, but other types of reflow will also work. The heat-up and cool-down rates (dT/dt) should be kept well under 4°C/sec. and preferably under 2°C/sec. After soldering, allow the parts to air cool to room temperature before cleaning.

Note: Presidio Components' parts are designed to reliably withstand reflow temperatures of 265°C maximum. If higher temperature reflow is required, consult factory.

HAND SOLDERING. If hand soldering must be used, preheat the parts as recommended above. A hot-air gun is an ideal tool for preheating. When hand soldering, avoid excessive heat, and keep the tip of the soldering iron as far away from the ceramic as possible.

As an example, for through-hole leaded parts, solder from the backside of the board. This will minimize the risk of thermally cracking the ceramic. After soldering, allow the parts to air cool to room temperature before cleaning.

PRE-TINNING LEADS. The leads do not need to be pre-tinned as they have already been tinned with Sn63 as part of our process.

In addition to the above, the following rules apply:

1. Do not dip stacked capacitors into a solder pot (to pre-tin, for example).
2. Do not touch-up a solder joint with a soldering iron. If touch up is necessary follow preheating and hand soldering recommendations above.
3. Do not deform leads or use excessive force to install parts.

Further, in accordance with Mil-PRF-49470, the following precaution should be followed:

“Precautionary Note: Capacitors covered by this specification sheet are very susceptible to thermal shock damage due to their large ceramic mass. Temperature profiles used should provide adequate temperature rise and cool-down time to prevent damage from thermal shock.”



STACKED CAPACITORS

X7R AND NPO

MAXIMUM CAPACITANCE (μF)

Ex: S201NP0134J1N3
(.13 μF , 25V, .200" total height)

Ex: S208X7R245K2J2
(2.4 μF , 50V, .220" total height)

Most popular sizes
shown in yellow

PRESIDIO CASE SIZE																				"B" Ht. Max. inch (mm)	No. of Caps per stack	
Case Code	08		17		32		36		16		01		47		42		21		06			
Dielectric	X7R	NPO	X7R	NPO	X7R	NPO	X7R	NPO	X7R	NPO	X7R	NPO	X7R	NPO	X7R	NPO	X7R	NPO	X7R	NPO		
25V (voltage code=1)	1.4	.036	1.8	.045	2.0	.050	2.0	.050	2.3	.060	2.5	.065	3.0	.080	3.3	.080	3.9	.10	5.0	.13	.150 (3.81)	1
	2.8	.072	3.6	.090	4.0	.10	4.0	.10	4.6	.12	5.0	.13	6.0	.16	6.6	.16	7.8	.20	10	.26	.200 (5.08)	2
	4.2	.11	5.4	.13	6.0	.15	6.0	.15	6.9	.18	7.5	.19	9.0	.24	10	.24	11	.30	15	.39	.275 (6.99)	3
	--	--	7.2	.18	--	--	--	--	9.2	.24	10	.26	12	.32	--	--	15	.40	20	.52	.350 (8.89)	4
	--	--	9.0	.22	--	--	--	--	11	.30	12	.32	15	.40	--	--	19	.50	25	.65	.425 (10.80)	5
50V (voltage code=2)	1.2	.030	1.5	.040	1.7	.040	1.7	.040	1.9	.050	2.1	.055	2.7	.070	2.7	.070	3.3	.080	4.5	.11	.150 (3.81)	1
	2.4	.060	3.0	.080	3.4	.080	3.4	.080	3.8	.10	4.2	.11	5.4	.14	5.4	.14	6.6	.16	9.0	.22	.220 (5.59)	2
	3.6	.090	4.5	.12	5.1	.12	5.1	.12	5.7	.15	6.3	.16	8.1	.21	8.1	.21	10	.24	13	.33	.310 (7.87)	3
	--	--	6.0	.16	--	--	--	--	7.6	.20	8.4	.22	10	.28	--	--	13	.32	18	.44	.400 (10.16)	4
	--	--	7.5	.20	--	--	--	--	9.5	.25	10	.27	13	.35	--	--	16	.40	22	.55	.490 (12.45)	5
75V (voltage code=2.5)	1.5	.035	1.8	.045	2.0	.050	2.0	.050	2.2	.055	2.4	.060	2.8	.075	2.8	.075	3.3	.085	4.8	.12	.160 (4.06)	1
	3.0	.070	3.6	.090	4.0	.10	4.0	.10	4.4	.11	4.8	.12	5.6	.15	5.6	.15	6.6	.18	9.0	.24	.240 (7.11)	2
	4.5	.105	5.4	.135	6.0	.15	6.0	.15	6.6	.165	7.2	.18	8.4	.21	8.4	.21	10	.24	13	.33	.400 (10.16)	3
	--	--	7.5	.21	--	--	--	--	9.5	.25	10	.27	13	.35	--	--	16	.40	22	.55	.520 (13.21)	4
	--	--	9.0	.24	--	--	--	--	11	.30	12	.33	15	.42	--	--	19	.50	25	.65	.760 (19.30)	6
100V (voltage code=3)	0.22	.012	0.3	.016	.36	.018	.36	.018	.39	.020	0.42	.022	.60	.027	.60	.030	.70	.036	1.0	.047	.160 (4.06)	1
	0.44	.024	0.6	.032	.72	.036	.72	.036	.78	.040	0.84	.044	1.2	.054	1.2	.060	1.4	.072	2.0	.094	.280 (7.11)	2
	--	--	0.9	.048	--	--	--	--	1.1	.060	1.2	.066	1.8	.071	--	--	2.1	.11	3.0	.14	.400 (10.16)	3
	--	--	1.2	.064	--	--	--	--	1.5	.080	1.7	.088	2.4	.11	--	--	2.8	.14	4.0	.19	.520 (13.21)	4
	--	--	--	--	--	--	--	--	1.9	.10	2.1	.11	3.0	.13	--	--	3.5	.18	5.0	2.3	.760 (19.30)	6
200V (voltage code=4)	0.11	.0060	0.14	.0075	.15	.0080	.15	.0080	0.18	.010	0.19	.011	.25	.013	.25	.013	.30	.016	.42	.022	.160 (4.06)	1
	0.22	.012	0.28	.015	.30	.016	.30	.016	0.36	.020	0.38	.022	.50	.026	.50	.026	.60	.032	.84	.044	.280 (7.11)	2
	--	--	0.42	.022	--	--	--	--	0.54	.030	0.57	.033	.75	.039	--	--	.90	.048	1.2	.066	.400 (10.16)	3
	--	--	0.56	.030	--	--	--	--	0.72	.040	0.76	.044	1.0	.052	--	--	1.2	.064	1.6	.088	.520 (13.21)	4
	--	--	--	--	--	--	--	--	0.90	.050	0.95	.055	1.2	.065	--	--	1.5	.080	2.1	.11	.760 (19.30)	6
DIMENSIONS inches (mm)	.215 (5.46)		.185 (4.70)		.300 (7.62)		.355 (9.02)		.235 (5.97)		.275 (6.99)		.310 (7.87)		.400 (10.16)		.300 (7.62)		.375 (9.53)		C \pm.025 (0.64)	
	.215 (5.46)		.275 (6.99)		.180 (4.57)		.150 (3.81)		.275 (6.99)		.275 (6.99)		.270 (6.86)		.220 (5.59)		.330 (8.38)		.375 (9.53)		D (Max) Width	
	.240 (6.10)		.210 (5.33)		.325 (8.26)		.380 (9.65)		.260 (6.60)		.300 (7.62)		.335 (8.51)		.425 (10.80)		.325 (8.26)		.400 (10.16)		E (Max) Length	
Leads per Side	2		3		2		2		3		3		3		2		3		4			
Chip Size	2018		1725		2917		3415		2225		2627		3026		3920		2832		3736			

Presidio's most popular sizes are highlighted. Choose these for best price, delivery and availability.

Notes:

1. "B" height dimensions are based on commonly ordered parts. Custom heights are available.
2. 75V parts are also available. Capacitance values of 75V parts are half-way between 50V and 100V parts.
3. Vertical stacks are sometimes useful for reducing the footprint; for availability, consult factory.

HOW TO ORDER

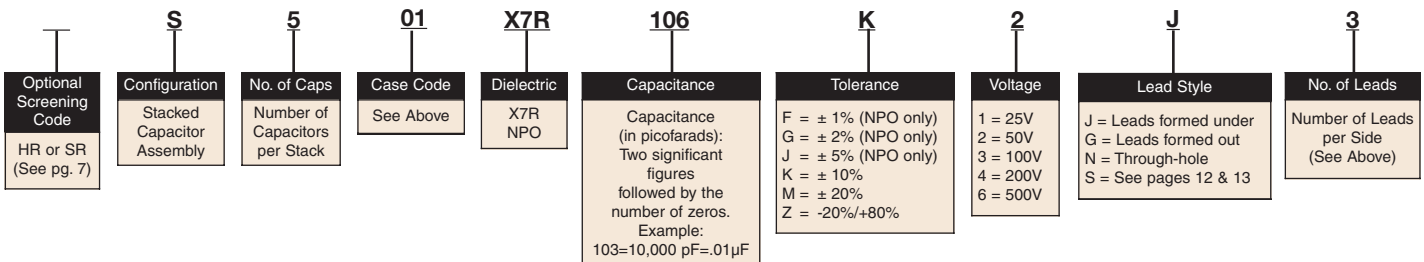

STACKED CAPACITORS X7R AND NPO MAXIMUM CAPACITANCE (µF)

Ex: 5205NP0324K1J4
(.32µF, 25V, .200" total height)

PRESIDIO CASE SIZE																		"B" Ht. Max. inch (mm)	No. of Caps per stack	
Case Code	02		03		07		37		05		04		48		44		13			
Dielectric	X7R	NPO	X7R	NPO	X7R	NPO	X7R	NPO	X7R	NPO	X7R	NPO	X7R	NPO	X7R	NPO	X7R			NPO
25V (voltage code=1)	5.6	.14	6.0	.15	6.5	.17	6.5	.17	7.0	.16	8.0	.20	8.0	.20	13	.33	20	.50	.150 (3.81)	1
	11	.28	12	.30	13	.34	13	.34	14	.32	16	.40	16	.40	26	.66	40	1.0	.200 (5.08)	2
	17	.42	18	.45	19	.51	19	.51	21	.48	24	.60	24	.60	39	1.0	60	1.5	.275 (6.99)	3
	22	.56	24	.60	26	.68	26	.68	28	.64	32	.80	32	.80	52	1.3	80	2.0	.350 (8.89)	4
	28	.70	30	.75	32	.85	32	.85	35	.80	40	1.0	40	1.0	65	1.6	100	2.5	.425 (10.80)	5
	33	.84	36	.90	39	1.0	39	1.0	42	.96	48	1.2	48	1.2	78	2.0	120	3.0	.500 (12.70)	6
50V (voltage code=2)	4.7	.12	5.0	.13	5.6	.14	5.6	.14	5.6	.14	6.8	.17	6.8	.17	10	.27	18	.40	.150 (3.81)	1
	9.4	.24	10	.26	11	.28	11	.28	11	.28	13	.34	13	.34	20	.54	36	.80	.220 (5.59)	2
	14	.36	15	.39	16	.42	16	.42	17	.42	20	.51	20	.51	30	.71	54	1.2	.310 (7.87)	3
	19	.48	20	.52	22	.56	22	.56	22	.56	27	.68	27	.68	40	1.1	72	1.6	.400 (10.16)	4
	23	.60	25	.65	28	.70	28	.70	28	.70	34	.85	34	.85	50	1.3	90	2.0	.490 (12.45)	5
	28	.72	30	.78	33	.84	33	.84	33	.84	41	1.0	41	1.0	60	1.6	110	2.4	.580 (14.73)	6
100V (voltage code=3)	3.2	.085	3.3	.090	3.7	.10	3.7	.10	4.0	.10	4.5	.12	4.5	.12	7.0	.20	12	.30	.160 (4.06)	1
	6.4	.17	6.6	.18	7.4	.20	7.4	.20	8.0	.20	9.0	.24	9.0	.24	14	.40	24	.60	.280 (7.11)	2
	9.6	.25	10	.27	11	.30	11	.30	12	.30	13	.36	13	.36	21	.60	36	.90	.400 (10.16)	3
	12	.34	13	.36	15	.40	15	.40	16	.40	18	.48	18	.48	28	.80	48	1.2	.520 (13.21)	4
	16	.42	16	.45	18	.50	18	.50	20	.50	22	.60	22	.60	35	1.0	60	1.5	.640 (16.26)	5
	--	--	--	--	--	--	--	--	--	--	--	--	27	.72	42	1.2	72	1.8	.760 (19.30)	6
200V (voltage code=4)	1.0	.050	1.0	.050	1.2	.060	1.2	.060	1.2	.056	1.5	.075	1.5	.075	2.2	.12	3.5	.18	.160 (4.06)	1
	2.0	.10	2.0	.10	2.4	.12	2.4	.12	2.4	.11	3.0	.15	3.0	.15	4.4	.24	7.0	.36	.280 (7.11)	2
	3.0	.15	3.0	.15	3.6	.18	3.6	.18	3.6	.17	4.5	.22	4.5	.22	6.6	.36	10	.54	.400 (10.16)	3
	4.0	.20	4.0	.20	4.8	.24	4.8	.24	4.8	.22	6.0	.30	6.0	.30	8.8	.48	14	.72	.520 (13.21)	4
	5.0	.25	5.0	.25	6.0	.30	6.0	.30	6.0	.28	7.5	.37	7.5	.37	11	.60	17	.90	.640 (16.26)	5
	--	--	--	--	--	--	--	--	--	--	--	--	9.0	.44	13	.72	21	1.1	.760 (19.30)	6
500V (voltage code=6)	.44	.024	.46	.025	.50	.027	.50	.027	0.55	.028	.60	.035	.60	.035	1.0	.056	1.6	.080	.160 (4.06)	1
	.88	.048	.92	.050	1.0	.054	1.0	.054	1.1	.056	1.2	.070	1.2	.070	2.0	.11	3.2	.16	.280 (7.11)	2
	1.3	.072	1.3	.075	1.5	.071	1.5	.071	1.6	.084	1.8	.10	1.8	.10	3.0	.16	4.8	.24	.400 (10.16)	3
	1.7	.096	1.8	.10	2.0	.11	2.0	.11	2.2	.11	2.4	.14	2.4	.14	4.0	.22	6.4	.32	.520 (13.21)	4
	2.2	.12	2.3	.12	2.5	.13	2.5	.13	2.7	.14	3.0	.17	3.0	.17	5.0	.28	8.0	.40	.640 (16.26)	5
	--	--	--	--	--	--	--	--	--	--	--	--	3.6	.21	6.0	.33	9.6	.48	.760 (19.30)	6
DIMENSIONS inches (mm)	.350 (8.89)		.415 (10.54)		.375 (9.53)		.550 (13.97)		.400 (10.16)		.475 (12.07)		.400 (10.16)		.375 (9.53)		.450 (11.43)		C ±.025 (0.64)	
	.400 (10.16)		.385 (9.78)		.425 (10.80)		.310 (7.87)		.425 (10.80)		.420 (10.67)		.500 (12.70)		.825 (20.96)		1.075 (27.31)		D (Max) Width	
	.375 (9.53)		.440 (11.18)		.400 (10.16)		.575 (14.61)		.440 (11.18)		.500 (12.70)		.425 (10.80)		.400 (10.16)		.500 (12.70)		E (Max) Length	
Leads per Side	4		4		4		3		4		4		5		8		10			
Chip Size	3439		4036		3640		5330		3941		4540		3949		3680		4399			

See Note 2

Presidio's most popular sizes are highlighted. Choose these for best price, delivery and availability.

Notes:

1. "B" height dimensions are based on commonly ordered parts. Custom heights are available.
2. 75V parts are also available. Capacitance values of 75V parts are half-way between 50V and 100V parts.
3. Vertical stacks are sometimes useful for reducing the footprint; for availability, consult factory.

Ex: 5513X7R805K6G10
(8µF, 500V, .640" total height)

HOW TO ORDER

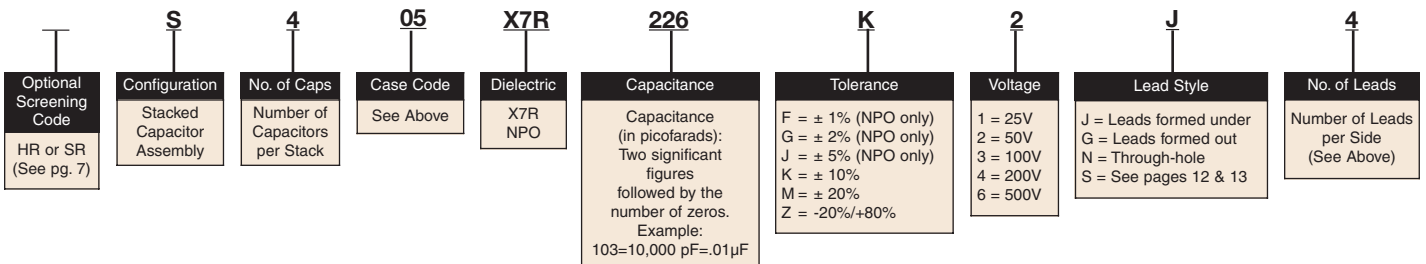

HIGH VOLTAGE STACKED CAPACITORS

PRESIDIO COMMON SIZES - X7R AND NPO

MAXIMUM CAPACITANCE (μF)

Ex: S156NPO303K9J6
(.03 μF , 1KV, .200" total height)

Ex: S358X7R214K13N6
(.21 μF , 3KV, .500" total height)

PRESIDIO CASE SIZE																"B" Ht. Max. Inch	No. of Caps per stack	
Case Code	52		53		37		54		55		56		57		58			
Dielectric	X7R	NPO	X7R	NPO	X7R	NPO	X7R	NPO	X7R	NPO	X7R	NPO	X7R	NPO	X7R	NPO		
1000V (voltage code=9)	.040	.0036	.080	.0075	.12	.010	.16	.014	.25	.022	.35	.030	.38	.033	.70	.060	.200 (5.08)	1
	.080	.0072	.16	.015	.24	.020	.32	.028	.50	.044	.70	.060	.76	.066	1.4	.12	.350 (8.89)	2
	.12	.011	.24	.022	.36	.030	.48	.042	.75	.066	1.0	.090	1.1	.10	2.1	.18	.500 (12.70)	3
	.16	.014	.32	.030	.48	.040	.64	.056	1.0	.088	1.4	.12	1.5	.13	2.8	.24	.650 (16.51)	4
2000V (voltage code=11)	.0080	.00075	.019	.0017	.027	.0024	.035	.0032	.055	.0050	.080	.0070	.090	.0082	.17	.015	.200 (5.08)	1
	.016	.0015	.038	.0034	.054	.0048	.070	.0064	.11	.010	.16	.014	.18	.016	.34	.030	.350 (8.89)	2
	.024	.0022	.057	.0051	.081	.0072	.10	.0096	.16	.015	.24	.021	.27	.024	.51	.045	.500 (12.70)	3
	.032	.0030	.076	.0068	.10	.0096	.14	.013	.22	.020	.32	.028	.36	.033	.68	.060	.650 (16.51)	4
3000V (voltage code=13)	--	--	.0070	.00065	.011	.0010	.014	.0013	.022	.0021	.033	.0030	.039	.0035	.070	.0065	.200 (5.08)	1
	--	--	.014	.0013	.022	.0020	.028	.0026	.044	.0042	.066	.0060	.078	.0070	.14	.013	.350 (8.89)	2
	--	--	.021	.0019	.033	.0030	.042	.0039	.066	.0063	.10	.0090	.11	.010	.21	.019	.500 (12.70)	3
	--	--	.028	.0026	.044	.0040	.056	.0052	.088	.0084	.13	.012	.15	.014	.28	.026	.650 (16.51)	4
4000V (voltage code=14)	--	--	--	--	.0055	.00050	.007	.00060	.012	.0010	.017	.0015	.020	.0018	.039	.0035	.200 (5.08)	1
	--	--	--	--	.011	.0010	.014	.0012	.024	.0020	.034	.0030	.040	.0036	.078	.0070	.350 (8.89)	2
	--	--	--	--	.016	.0015	.021	.0018	.036	.0030	.051	.0045	.060	.0054	.11	.010	.500 (12.70)	3
	--	--	--	--	.022	.0020	.028	.0024	.048	.0040	.068	.0060	.080	.0072	.15	.014	.650 (16.51)	4
5000V (voltage code=15)	--	--	--	--	.0030	.00033	.0040	.00042	.0065	.00070	.0090	.0010	.011	.012	.022	.0024	.200 (5.08)	1
	--	--	--	--	.0060	.00066	.0080	.00084	.013	.0014	.018	.0020	.022	.024	.044	.0048	.350 (8.89)	2
	--	--	--	--	.0090	.0010	.012	.0012	.019	.0021	.027	.0030	.033	.036	.066	.0072	.500 (12.70)	3
	--	--	--	--	.012	.0013	.016	.0016	.026	.0028	.036	.0040	.044	.048	.088	.0096	.650 (16.51)	4
DIMENSIONS inches (mm)	.300 (7.62)		.415 (10.54)		.550 (13.97)		.500 (12.70)		.600 (15.24)		.700 (17.78)		.975 (24.77)		1.375 (34.93)		C \pm .025 (0.64)	
	.260 (6.60)		.350 (8.89)		.320 (8.13)		.460 (11.68)		.560 (14.22)		.660 (16.76)		.520 (13.21)		.670 (17.02)		D (Max.) Width	
	.325 (8.26)		.440 (11.18)		.580 (14.73)		.525 (13.34)		.625 (15.88)		.725 (18.42)		1.000 (25.40)		1.400 (35.56)		E (Max.) Length	
Leads per Side	3		4		3		4		5		6		5		6			
Chip Size	2824		3933		5330		4844		5854		6864		9650		13565			

PRESIDIO LEAD STYLE AND DIMENSIONS

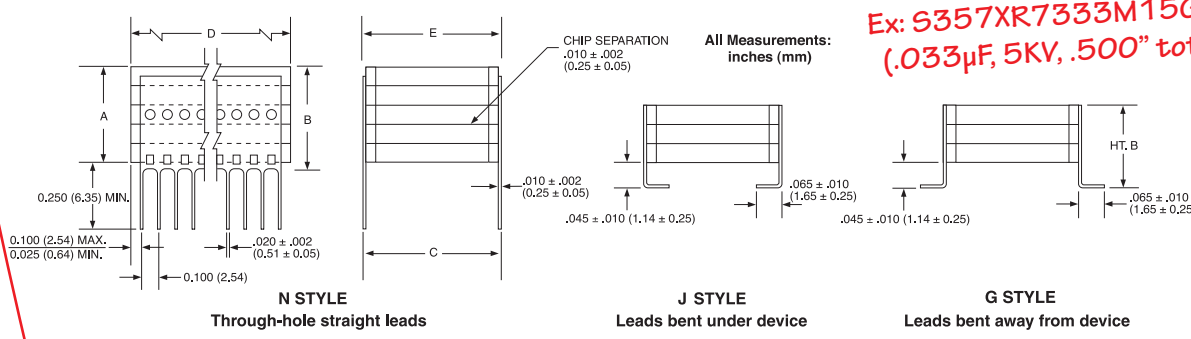

HOW TO ORDER

Optional Screening Code HR or SR (See pg. 7)	S Configuration Stacked Capacitor Assembly	3 No. of Caps Number of Capacitors per Stack	52 Case Code See Above	X7R Dielectric X7R NPO	124 Capacitance Capacitance (in picofarads): Two significant figures followed by the number of zeros. Example: 103=10,000 pF=.01 μF	K Tolerance F = \pm 1% (NPO only) G = \pm 2% (NPO only) J = \pm 5% (NPO only) K = \pm 10% M = \pm 20% Z = -20%/+80%	9 Voltage 9 = 1000V 11 = 2000V 13 = 3000V 14 = 4000V 15 = 5000V	J Lead Style J = Leads formed under G = Leads formed out N = Through-hole S = See pages 12 & 13	3 No. of Leads Number of Leads per Side (See Above)
---	--	--	------------------------------	---------------------------------	---	--	---	--	---

PRESIDIO COMPONENTS, INC.

7169 Construction Court, San Diego, CA 92121 USA • Tel: 858-578-9390 • Fax: 800-538-3880 or 858-578-6225
www.presidiocomponents.com • info@presidiocomponents.com

POWER-STACK™ CAPACITORS

STACKED CERAMIC CAPACITORS FOR USE IN HIGH POWER, HIGH VIBRATION,
AND HIGH MECHANICAL SHOCK ENVIRONMENTS
AVAILABLE IN ALL DIELECTRIC TYPES AND VOLTAGE RATINGS



SUPERIOR PERFORMANCE

ESL is typically less than half of a 49470 style device, as a result of the vertical plate design of the capacitors, and the current flow symmetry of the flying lead design.

ESR is low due to both the vertical layer chip attachment to the base plate, and the dual attachment of the top lead assembly.

HEAT DISSIPATION is achieved by conduction through the robust base plate connection.

VIBRATION PERFORMANCE The robust base plate and the dual top lead attachment provide superior tolerance for vibration.

VOLTAGES 25V to 1000V

DIELECTRICS

K14	NPQ Porcelain	K2000	BX
K100	NPO/BP	K5000	X7R
K500	N2T		

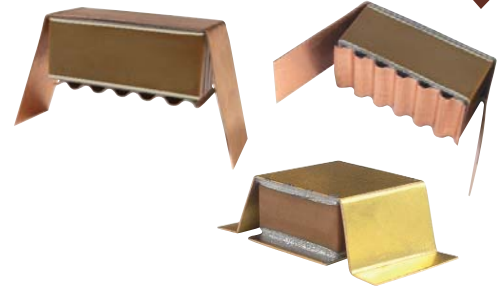

ASSEMBLY DETAILS

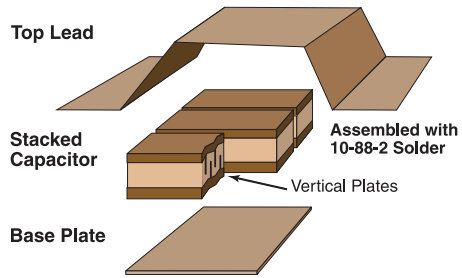

DIMENSIONS

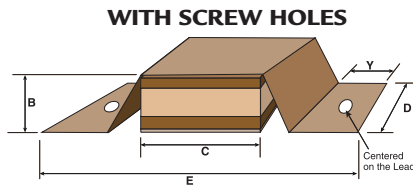
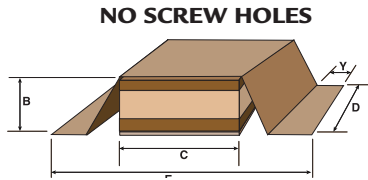

THROUGH-HOLE RIBBON

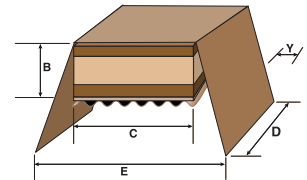

SIZE	NO SCREW HOLES		WITH SCREW HOLES		THROUGH-HOLE RIBBON		
	HEIGHT B Inches (mm)	LENGTH C Inches (mm)	WIDTH D Inches (mm)	OVERALL LENGTH E Inches (mm)	FOOT WIDTH Y Inches (mm)	OVERALL LENGTH E Inches (mm)	FOOT WIDTH Y Through-Hole Ribbon
	MAX	± 0.015 (0.38)	± .025 (0.64)	± .025 (0.64)	± 0.015 (0.38)	± .025 (0.64)	± .020 (0.51)
PS4	0.250 (6.35)	0.400 (10.16)	0.400 (10.16)	0.640 (16.26)	0.060 (1.52)	1.100 (27.94)	0.300 (7.62)
PS9	0.500 (12.70)	1.050 (26.67)	0.500 (12.70)	1.400 (35.56)	0.100 (2.54)	1.800 (45.72)	0.300 (7.62)
							Call Presidio for More Information

AVAILABLE CAPACITANCE VALUES

	PS4					PS9				
	NPQ	NPO	N2T	BX	X7R	NPQ	NPO	NT2	BX	X7R
25V				5.6µF	15µF				56µF	120µF
50V		180nF	1µF	4.7µF	10µF		2µF	10µF	47µF	100µF
100V	27nF	100nF	.47µF	2.7µF	5.6µF	.22µF	1µF	4.7µF	22µF	47µF
200V	12nF	47nF	.33µF	1.2µF	1.8µF	.1µF	.39µF	3.3µF	10µF	15µF
500V	6.8nF	27nF	.27µF	.68µF	.82µF	47nF	.18µF	2.2µF	4.7µF	5.6µF
1000V	1.8nF	6.8nF	82nF	.18µF	.22µF	12nF	47nF	.56µF	1.2µF	1.5µF

EXAMPLE: PS4X7R106K3

HOW TO ORDER

PS4	X7R	106	K	3	H
Size Code	Dielectric Code	Capacitance	Tolerance Code	Voltage Code	Mounting
See Above	NPQ BX NPO X7R N2T	(in picofarads) Two significant figures followed by the number of zeros. Example: 103 = 10,000pF = .01µF	F = 1% (NPO + NPQ) G = 2% (NPO + NPQ) J = 5% (NPO + NPQ) K = ± 10% M = ± 20% Z = +80% / -20% P = +100% / -0%	1 = 25 V 2 = 50 V 3 = 100 V 4 = 200 V 6 = 500 V 9 = 1000 V	Part includes Screw Holes (optional) Blank = No Screw Holes

PRESIDIO COMPONENTS, INC.

17169 Construction Court, San Diego, CA 92121 USA • Tel: 858-578-9390 • Fax: 800-538-3880 or 858-578-6225
www.presidiocomponents.com • info@presidiocomponents.com

LOW PROFILE 'S' LEAD CAPACITORS

LOW PROFILE · LOW STANDOFF

APPLICATIONS:

- Industrial
- Military
- Space

FEATURES:

- Low center of gravity
- Excellent thermal coefficient of expansion compliance with board
- Tested to 49470
- Available in most chip sizes



CERAMIC TYPE:

- NPO, NPQ, N2T, BX or X7R

TOP VIEW — END VIEW — SIDE VIEW

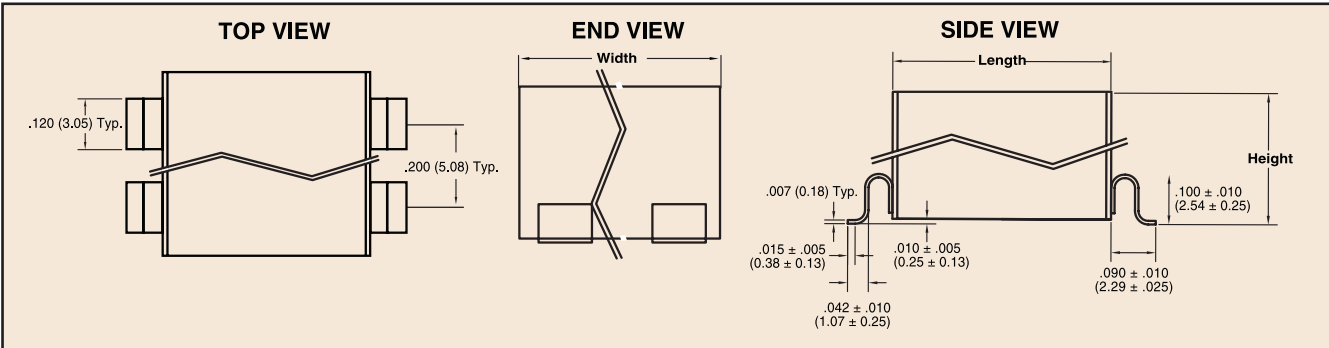

LOW STANDOFF COMPARISON

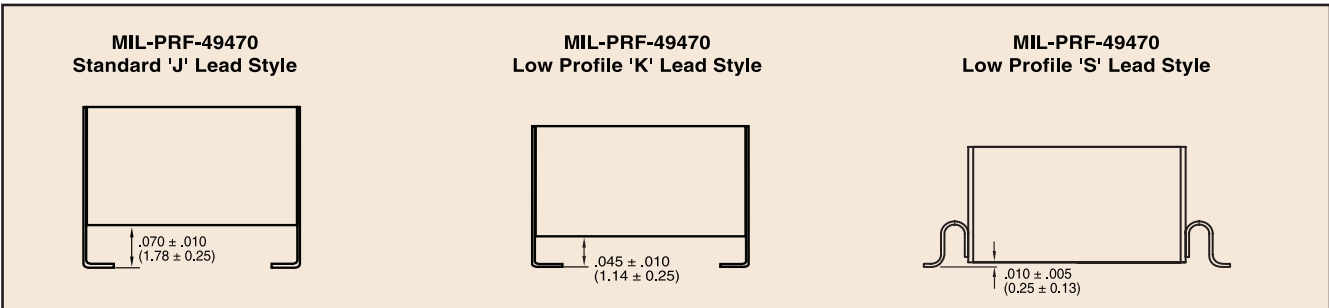

HOW TO ORDER

HR	S	3	01	X7R	605	K	2	S	1
Screening Code HR or SR (See pg. 7)	Product Code Stacked Capacitor Assembly	Stack Size Number of Capacitor Chips	Case Size Available in many sizes	Dielectric X7R, BX, NPO, NPQ, BR, BQ	Capacitance Capacitance (in picofarads): Two significant figures followed by the number of zeros. Example: 103=10,000 pF=.01μF	Tolerance J = ± 5% K = ± 10% M = ± 20% Z = -20% / +80%	Voltage 1 = 25V 2 = 50V 3 = 100V 4 = 200V 6 = 500V	Lead Style 'S' Leads	Leads Number of Leads per Side

LOW PROFILE 'S' LEAD CAPACITORS MAXIMUM CAPACITANCE

MIL-PRF-49470 STYLE CASE SIZES								
49470 Case Size	Style 5		Style 4		Style 3		Height B inches (mm)	# Chips (per stack)
Presidio Case Size	01		05		13			
Dielectric	BX/BR/BQ (µF)	BP (µF)	BX/BR/BQ (µF)	BP (µF)	BX/BR/BQ (µF)	BP (µF)		
50V (BX)	1.2	.056	3.0	.12	10	.39	.135 (3.43)	1
	2.2	.10	6.0	.27	18	.82	.255 (6.48)	2
	3.3	.15	8.2	.33	33	1.2	.375 (9.53)	3
	—	—	12	.47	39	1.8	.495 (12.57)	4
	—	—	15	.56	47	2.2	.665 (16.89)	5
100V (BX)	0.68	.039	1.5	.10	5.6	.3	.135 (3.43)	1
	1.2	.082	2.7	.22	12	.68	.255 (6.48)	2
	1.8	.12	4.7	.27	18	1.0	.375 (9.53)	3
	—	—	6.8	.39	22	1.5	.495 (12.57)	4
	—	—	8.2	.56	27	1.8	.665 (16.89)	5
200V (BR)	0.27	.022	0.68	.068	2.7	.18	.135 (3.43)	1
	0.56	.039	1.5	.10	5.6	.39	.255 (6.48)	2
	0.82	.056	2.2	.15	8.2	.56	.375 (9.53)	3
	—	—	3.3	.22	10	.68	.495 (12.57)	4
	—	—	3.9	.27	12	1.0	.665 (16.89)	5
500V (BQ)	0.15	.010	.39	.022	1.0	.082	.135 (3.43)	1
	0.27	.018	.68	.039	2.2	.18	.255 (6.48)	2
	0.47	.027	1.2	.068	3.9	.27	.375 (9.53)	3
	—	—	1.5	.10	4.7	.33	.495 (12.57)	4
	—	—	1.8	.12	5.6	.39	.665 (16.89)	5
C ± .025 in. (± .64 mm)	.250 (6.35)		.400 (10.16)		.450 (11.43)			
D Max. in. (mm)	.275 (6.99)		.425 (10.80)		1.075 (27.31)			
E Max. in. (mm)	.300 (7.62)		.440 (11.18)		1.075 (27.31)			
Leads per Side	1		2		5			

PRESIDIO CASE SIZES — X7R AND NPO DIELECTRIC								
Presidio Case Size	01		05		13		Height inches (mm)	# Chips (per stack)
Chip Size	2627		3941		4399			
Dielectric	X7R (µF)	NPO (µF)	X7R (µF)	NPO (µF)	X7R (µF)	NPO (µF)		
25V	2.5	0.065	7.0	0.16	20.0	0.5	.110 (2.79)	1
	5.0	0.13	14.0	0.32	40.0	1.0	.160 (4.06)	2
	7.5	0.19	21.0	0.48	60.0	1.5	.235 (5.97)	3
	10.0	0.26	28.0	0.64	80.0	2.0	.310 (7.87)	4
	—	—	35.0	0.80	100.0	2.5	.385 (9.78)	5
	—	—	42.0	0.96	120.0	3.0	.460 (11.68)	6
50V	2.1	0.055	5.6	0.14	18.0	0.4	.110 (2.79)	1
	4.2	0.11	11.0	0.28	36.0	0.8	.180 (4.57)	2
	6.3	0.16	17.0	0.42	54.0	1.2	.270 (6.86)	3
	8.4	0.22	22.0	0.56	72.0	1.6	.360 (9.14)	4
	—	—	28.0	0.70	90.0	2.0	.450 (11.43)	5
	—	—	33.0	0.84	110.0	2.4	.540 (13.72)	6
100V	1.4	0.04	4.0	0.1	12.0	0.3	.120 (3.05)	1
	2.8	0.08	8.0	0.2	24.0	0.6	.240 (6.10)	2
	4.2	0.12	12.0	0.3	36.0	0.9	.360 (9.14)	3
	—	—	16.0	0.4	48.0	1.2	.480 (12.19)	4
	—	—	20.0	0.5	60.0	1.5	.600 (15.24)	5
	—	—	—	—	72.0	1.8	.720 (18.29)	6
200V	0.42	0.022	1.2	0.056	3.5	0.18	.120 (3.05)	1
	0.84	0.044	2.4	0.11	7.0	0.36	.240 (6.10)	2
	1.20	0.066	3.6	0.17	10.0	0.54	.360 (9.14)	3
	—	—	4.8	0.22	14.0	0.72	.480 (12.19)	4
	—	—	6.0	0.28	17.0	0.90	.600 (15.24)	5
	—	—	—	—	21.0	1.10	.720 (18.29)	6
500V	0.19	0.011	0.55	0.028	1.6	0.08	.120 (3.05)	1
	0.38	0.022	1.10	0.056	3.2	0.16	.240 (6.10)	2
	0.57	0.033	1.60	0.084	4.8	0.24	.360 (9.14)	3
	—	—	2.20	0.110	6.4	0.32	.480 (12.19)	4
	—	—	2.70	0.140	8.0	0.40	.600 (15.24)	5
	—	—	—	—	9.6	0.48	.720 (18.29)	6
C ± .025 in. (± .64 mm)	.275 (6.99)		.400 (10.16)		.450 (11.43)			
D Max. in. (mm)	.275 (6.99)		.425 (10.80)		1.075 (27.31)			
E Max. in. (mm)	.300 (7.62)		.440 (11.18)		.500 (12.70)			
Leads per Side	1		2		5			

Height dimensions based on commonly ordered parts. Custom heights available.

Notes: 1. 75V parts are also available. Capacitance values of 75V parts are half-way between 50V and 100V.
2. Other sizes and capacitance values available. Consult factory.



PRESIDIO COMPONENTS, INC.

7169 Construction Court, San Diego, CA 92121 USA • Tel: 858-578-9390 • Fax: 800-538-3880 or 858-578-6225
www.presidiocomponents.com • info@presidiocomponents.com

HIGH FREQUENCY-HIGH POWER CAPACITORS

FOR AC LINE FILTERING OR HIGH POWER RF APPLICATIONS

TYPE N2200 DIELECTRIC

APPLICATIONS:

- AC line filtering, typically from 110-230 volts AC, 80 to 400 Hz
- High power RF at high voltages, 500 volts to 5,000 volts

FEATURES:

- Low dissipation factor (DF)
- Low self-heating
- Low ESR over a wide frequency range
- High reliability
- Stable capacitance vs frequency
- No aging rate

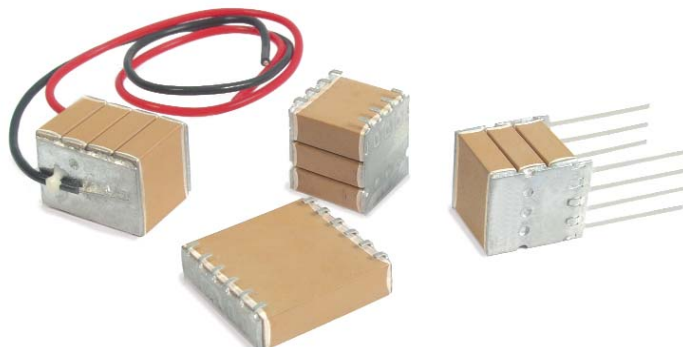

CERAMIC TYPE:

- Type N2200, NTC dielectric (combines the high K of an X7R dielectric with the stability of an NPO dielectric)
- Temperature coefficient: -2200ppm/°C typical
- N2200 Dielectric code is "N2T"

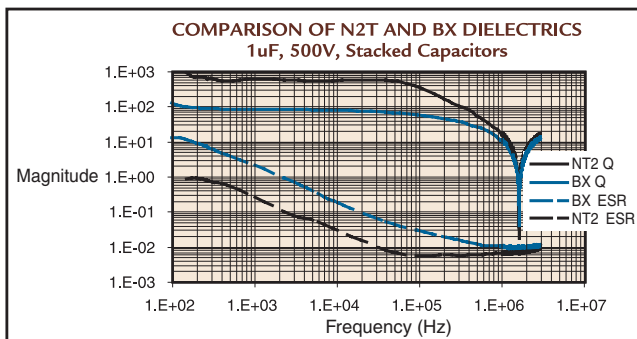
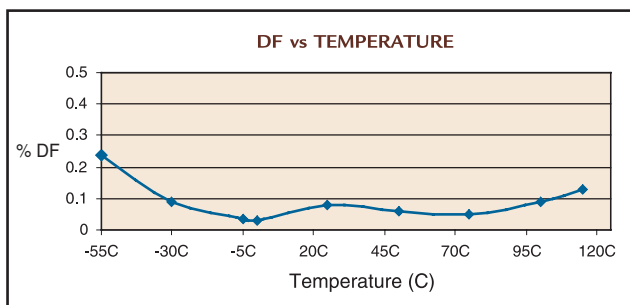
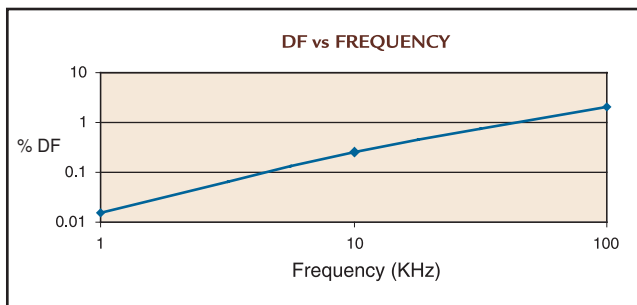
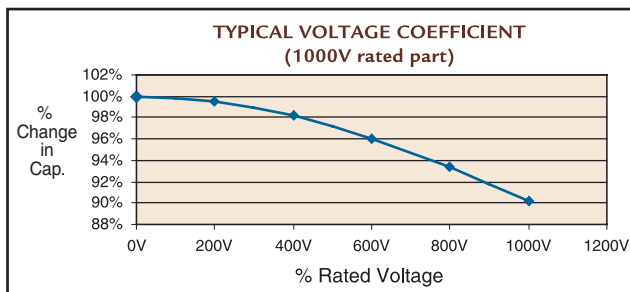
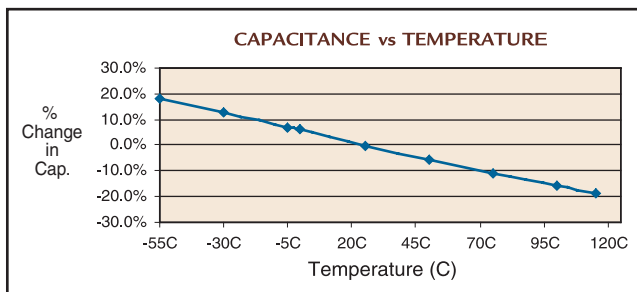

POPULAR PART NUMBERS		
Capacitance	Voltage	Part Number
.068 μF	500 V	RL2422N2T683K6E250
.330 μF	500 V	RL3941N2T334K6E400
1 μF	500 V	S405N2T105K6N4
.050 μF	1000 V	RL3736N2T503K9E375
.015 μF	5000 V	RL8557N2T153K15E850

Notes: 1. Capacitors available as radial leaded or stacked.
 2. Other sizes and voltages are available; consult factory.

INTERDIGITATED STACKED CAPACITORS

FOR HIGHER FREQUENCY SWITCH MODE POWER SUPPLIES

APPLICATIONS:

- Output filtering in Switch Mode Power Supplies (SMPS)
- Applications that require higher self-resonant frequency than conventional SMPS capacitors
- Gives less noise on power supply output

FEATURES:

- Lower inductance (ESL)
- Higher self-resonant frequency
- Opposite polarity on each lead gives opposing magnetic fields, resulting in lower ESL while the capacitor is charging
- High capacitance
- Meets standard SMPS capacitor specifications

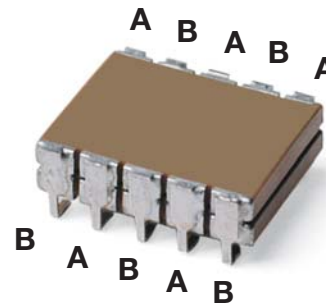

Interdigitated configuration results in reduced ESL

CERAMIC TYPE:

- X7R high K dielectric
- Temperature coefficient: $\pm 15\%$ maximum, -55°C to $+125^{\circ}\text{C}$

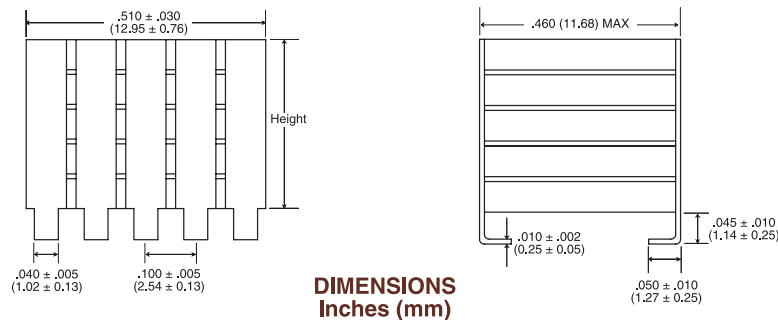
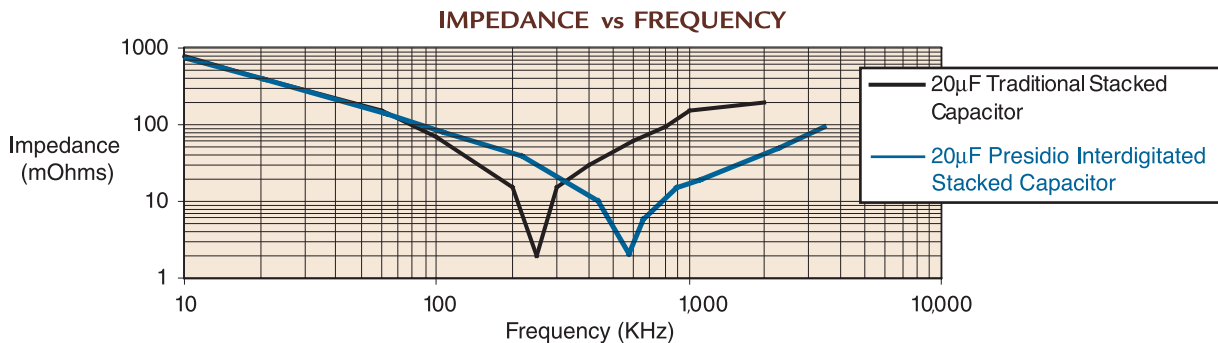

POPULAR PART NUMBERS				
Height inches (mm)	50 Volt		25 Volt	
.200 (5.08)	10 μF	HRSI214X7R106M2J5	15 μF	HRSI214X7R156M1J5
.300 (7.62)	15 μF	HRSI314X7R156M2J5	22 μF	HRSI314X7R226M1J5
.400 (10.16)	20 μF	HRSI414X7R206M2J5	30 μF	HRSI414X7R306M1J5
.500 (12.70)	25 μF	HRSI514X7R256M2J5	39 μF	HRSI514X7R396M1J5

PRESIDIO CUSTOM PRODUCTS



CUSTOM LEADS

PRESIDIO COMPONENTS, INC. maintains more than 70 million standard commercial and military parts in inventory. If you need a custom product, call our engineering team.



'S' LEADS

Custom products include non-standard part sizes and voltages such as high voltage, high temperature, high "Q", custom leads, cryogenic ceramics, negative and positive temperature characteristic ceramics, and piezoelectric formulations. European sizes are also available.

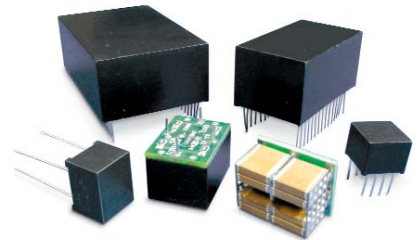

ENCAPSULATED

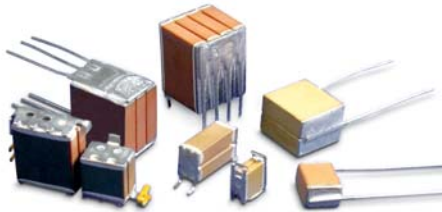

**CUSTOM STACKED
CUSTOM ASSEMBLY**

Backed with numerous patents and hundreds of years of combined experience, Presidio's engineering team is ready and able to create the ideal solution for any application.



**HIGH TEMP
DOWN HOLE OIL**



**MULTILAYER CO-FIRED
PIEZO**



**POWER-STACK™
CAPACITORS**

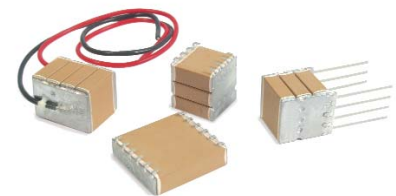

**HIGH FREQUENCY
HIGH POWER**

OTHER PRESIDIO PRODUCT CATALOGS

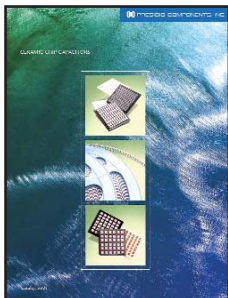

**CERAMIC CHIP
CAPACITORS**



**MIL-PRF-49470
VS 87106 CROSS
REFERENCE**



**EUROPEAN SIZES
SMPS STACKED
CAPACITORS**

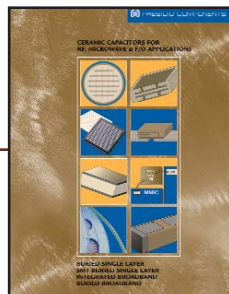

**CERAMIC
CAPACITORS
FOR RF,
MICROWAVE
& FIBER OPTIC
APPLICATIONS**

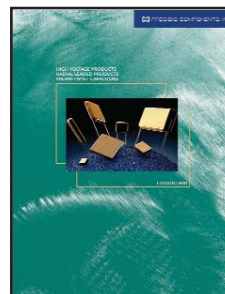

**HIGH VOLTAGE PRODUCTS
RADIAL LEADED PRODUCTS
MIL-PRF-49467 CAPACITORS**

