

1.0 INTRODUCTION

To support designers and manufacturers of electronic circuitry, FERROXCUBE manufactures a comprehensive line of ferrite EMI-suppression products for use on circuit boards, through-hole as well as surface-mountable.

The demand for SMD-suppression components is still growing. Therefore FERROXCUBE has focused its effort and expertise to develop new types and sizes through a continuously optimized design process to complete our SMD selection:

- **Low profiled SMD-bead for flat designs**
- **SMD-Current Compensated Chokes**
- **SMD-Wide Band Chokes**
- **Gapped SMD-bead for Power inductor**

Our recognized know-how and staff of application engineers are the basis of the technical support, which is entirely at your disposal for your comments and inquiries.

Well controlled manufacturing processes, automated production lines and measuring equipment and a long experience in ferrites make FERROXCUBE a flexible, capable and reliable partner, able to advise and provide also custom-designed products, either completely new or similar to existing types.

FERROXCUBE offers smart solutions to comply with the more and more severe EMC norms and requirements: our new SMD-components are suitable to prevent generated interference and to suppress incoming noise signals and parasitic oscillations.

2.0 EMI INTERFERENCE SUPPRESSION AND EMC ELECTROMAGNETIC COMPATIBILITY

With the ever increasing intensive use of electronic equipment Electromagnetic Compatibility (EMC) has become an important issue. Since 1928 laws specify limits of the level of interference caused by equipment (EME; Electromagnetic Emission) and also the sensitivity of equipment to incoming interference (EMS; Electromagnetic Susceptibility).

Limiting curves are defined by international organizations and national agencies such as CISPR, FCC in the USA, the VDE in Germany and VCCI in Japan. Since density of equipment increases, laws will become more stringent in the near future. EMC principles are explained in figure 1.

During the design phase, problems with interference can be avoided to some extent. Often additional suppression components such as capacitors and inductors will be necessary to meet the required levels. Inductive components are very effective in blocking interfering signals, especially at high frequencies.

Capacitors are used as shunt impedance (ZP) for the unwanted signal. Unfortunately for high frequencies, most capacitors do not have the low impedance one might expect because of parasitic inductance or resistance (Fig. 2).

Inductors (ZFXC) are used in series with the load impedance (ZL). Most inductive interference suppression components (choke, bead) are based upon a ferrite core.

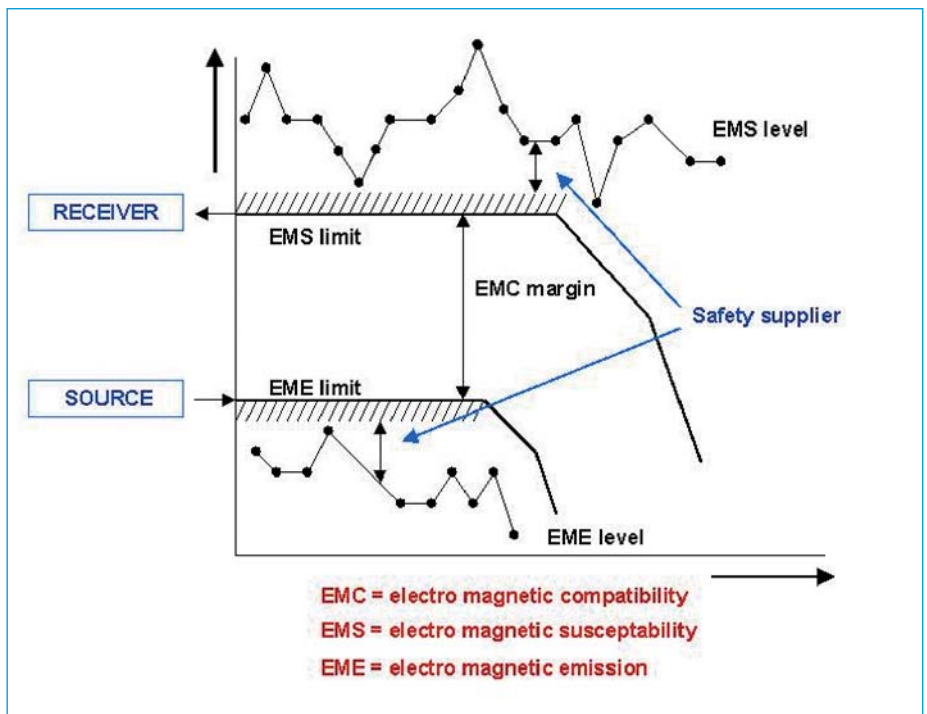

Figure 1. Principles of EMC

Ferrite inductors provide low impedance for the wanted signal, but high impedance for the interfering, unwanted signal (noise).

The effectiveness of noise suppression is found by comparing the situation without and with ferrite inductor (see figure 3. A measure for the suppressors effectiveness is the insertion loss (attenuation), which is defined as the ratio of noise voltages (U_{Ia} / U_{Ib}) across the load impedance Z_L without and with inductor Z_{fxc} :

Insertion loss is given by:

$$20 \times \log (U_{Ia} / U_{Ib}) = 20 \times \log (1 + (Z_{fxc} / ((Z_i + (Z_L)))) \text{ in [dB]}$$

The parameter to characterize the inductor performance, independent of a circuit, is its impedance as a function of frequency ($Z_{fxc} = f(\text{Freq})$).

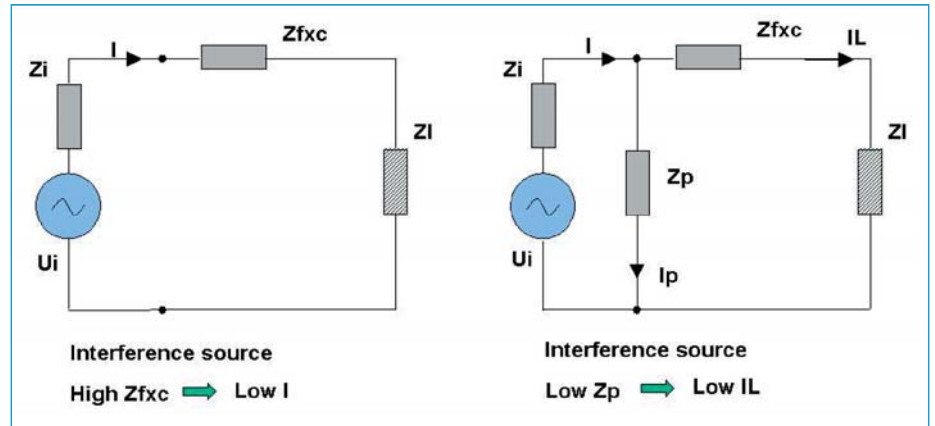

Figure 2. Basic suppression circuits

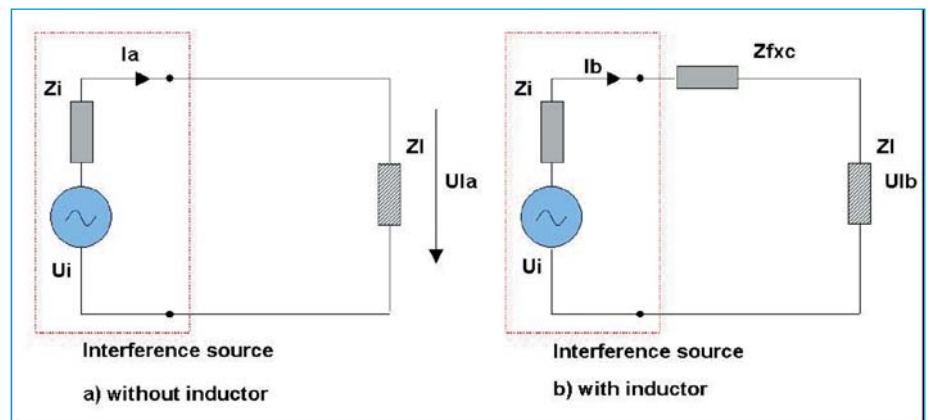

Figure 3. Interference basic circuit with inductance

3.0 MATERIAL CHARACTERISTICS

• 3S1 and 4S2

Symbol	Conditions			Value / grade		Unit
				3S1	4S2	
μ	≤ 10 KHz	0.1 mT	25°C	4000 \pm 20%	850 \pm 20%	-
B	10 KHz	250 A / m	25°C	\approx 350	\approx 270	mT
	10 KHz	250 A / m	100°C	\approx 180	\approx 180	mT
Z	1 MHz		25°C	≥ 30	-	Ω
	10 MHz		25°C	≥ 60	-	Ω
	30 MHz			-	≥ 50	Ω
	300 MHz			-	≥ 90	Ω
ρ	DC		25°C	≈ 1	$\approx 10^5$	Ωm
Tc				≥ 125	≥ 125	°C
DENSITY				≈ 4900	≈ 5000	Kg/m ³

Table 1. 3S1 and 4S2 characteristics

• 3S4 and 4B1

Symbol	Conditions			Value / grade		Unit
				3S4	4B1	
μ	≤ 10 KHz	0.1 mT	25°C	1700 \pm 20%	250 \pm 20%	-
B	10 KHz	250 A / m	25°C	\approx 320	\approx 310	mT
	10 KHz	250 A / m	100°C	\approx 170	\approx 260	mT
tan δ / μi	1 MHz	0.1 mT	25°C	-	$\leq 90 \cdot 10^6$	-
	3 MHz	0.1 mT	25°C	-	$\leq 300 \cdot 10^6$	-
Z	3 MHz			≥ 25	-	Ω
	30 MHz			≥ 60	-	Ω
	100 MHz			≥ 80	-	Ω
	300 MHz			≥ 90	-	Ω
ρ	DC		25°C	$\approx 10^3$	$\approx 10^5$	Ωm
Tc				≥ 110	≥ 250	°C
DENSITY				≈ 4800	≈ 4600	Kg/m ³

Table 2. 3S4 and 4B1 characteristics

• 3C96 and 4S3

Symbol	Conditions			Value / grade		Unit
				3C96	4S3	
μ	≤ 10 KHz	0.1 mT	25°C	2000 \pm 20%	250 \pm 20%	-
B	10 KHz	250 A / m	25°C	\approx 500	\approx 310	mT
	10 KHz	250 A / m	100°C	\approx 440	\approx 260	mT
$\tan \delta / \%$	1 MHz	0.1 mT	25°C	-	$\leq 90 \cdot 10^6$	-
	3 MHz	0.1 mT	25°C	-	$\leq 300 \cdot 10^6$	-
Z	30 MHz			-	≥ 10	Ω
	50 MHz			-	≥ 40	Ω
	200 MHz			-	≥ 200	Ω
	500 MHz			-	≥ 250	Ω
ρ	DC		25°C	\approx 5	$\approx 10^5$	Ωm
Tc				≥ 240	≥ 250	°C
DENSITY				\approx 4800	\approx 4600	Kg/m ³

Table 3. 3C96 and 4S3 characteristics

• 3S5 and 4S60

Symbol	Conditions			Value / grade		Unit
				3S5	4S60	
μ	≤ 10 KHz	0.1 mT	25°C	3800 \pm 20%	2000 \pm 20%	-
B	10 KHz	250 A / m	25°C	\approx 545	\approx 260	mT
	10 KHz	250 A / m	100°C	\approx 435	\approx 85	mT
Q factor	0.1 MHz	-	25°C	-	40	-
Z	1 MHz			≥ 20	-	Ω
	10 MHz			≥ 40	-	Ω
ρ	DC		25°C	\approx 10	$\approx 10^5$	Ωm
Tc				≥ 255	≥ 100	°C
DENSITY				\approx 4800	4700 - 5100	Kg/m ³

Table 4. 3S5 and 4S60 characteristics

4.0 CHIP BEADS FOR INTERFERENCE SUPPRESSION

Ferroxcube ferrite beads are well known to suppress unwanted interference. They are supplied as:

- Suppression bead for shifting on a wire
- Bead-on-wire for through-hole mounting on a PCB

In response to market demands for smaller lighter and more integrated electronic devices FERROXCUBE added a series of SMD-type chip beads to the bead families. The ferrite chip bead EMI-suppressor provide a powerful means of EMI / RFI attenuation for electronic equipment. Four compact sizes are standardized and available in suppression material grades 3S1, 4S2, 4S3, 3S5 and 4S60 according to impedance/frequency requirements at each application.

4.1 PRODUCT APPLICATION

Chip beads have the same application area as beads-on-wire, but in addition they offer the full advantages of SMD technology like economical mounting, high packing density of components, reliable soldering etc. Applications for these components can be found in e.g.:

- Office automation equipment
- Electronic data processing equipment
- Telecommunication
- Automotive
- Consumer electronic products (audio / video)
- Domestic appliances

4.2 PRODUCT SPECIFICATION

4.2.1 GENERAL SPECIFICATION

Chip beads are available in four standard sizes and five suppression material grades. A chip bead is made of a ferrite tube with a rectangular cross section and a lead through flat tinned copper wire, which is bending around the edges and forms the terminals of the component. This design offers many superior mechanical and electrical features.

FEATURES:

- Low magnetic leak inductance due to magnetic closed circuit
- Resistant to mechanical shocks and pressure
- Excellent solder ability (reflow soldering, flow soldering, iron soldering)
- Terminals are highly resistant to pull forces
- Low tolerances of mechanical dimensions enable automatic mounting

APPLICATIONS:

- EMI-suppression
- Decoupling
- Damping parasitic oscillations

APPLICABLE MATERIALS:

- 3S5 for frequencies up to 30 MHz
- 3S1 for frequencies up to 100 MHz
- 4S60 for frequencies up to 300 MHz
- 4S2 for frequencies up to 1000 MHz
- 4S3 for frequencies up to 1200 MHz

TYPE DESCRIPTION:

e.g. BDS3/1.8/5.3-3S1-Z
(1)(2) (3) (4) (5) (6)

- (1) Product type (BDS = Bead for Surface mounting)
- (2) Width (in mm)
- (3) Height (in mm)
- (4) Length (in mm)
- (5) Material grade (e.g. 3S1)
- (6) -Z lead-free version*

*Note: Not lead-free old version available depending on stock. All new codes are leadfree (not -Z included on type description)

ORDERING CODE (12 NC):

e.g. 433003036301

The first 11 digits of the 12NC are sufficient to order the desired chip bead. The type description is additional information.

4.2.2 SHAPE AND DIMENSIONS

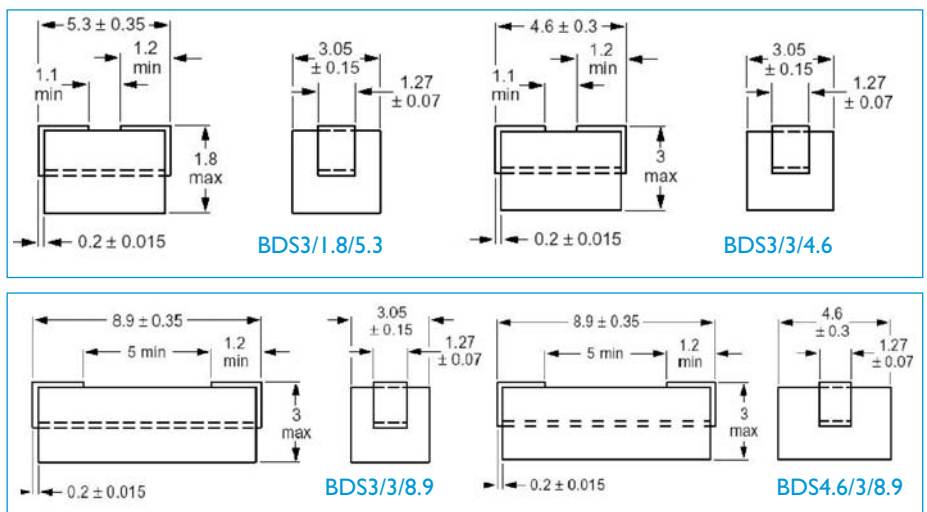

Figure 4. Chip bead dimensions (in millimeters)

4.2.3 ELECTRICAL CHARACTERISTICS

TYPE	IMPEDANCE [Ω] AT FREQUENCY [MHz]								Mass (g)
	1	3	10	25	30	100	300	700	
BDS3/1.8/5.3-3S1	-	-	28	33	-	25	-	-	\approx 0.15
BDS3/1.8/5.3-4S2	-	-	-	25	-	38	45	-	\approx 0.3
BDS3/3/4.6-3S1	-	25	45	35	-	-	-	-	\approx 0.15
BDS3/3/4.6-4S2	-	-	-	30	-	50	55	-	\approx 0.3
BDS3/3/4.6-3S5	15	-	35	-	30	-	-	-	\approx 0.15
BDS3/3/4.6-4S60	-	-	25	-	35	38	-	-	\approx 0.3
BDS3/3/4.6-4S3	-	-	-	-	-	47	66	70	\approx 0.3
BDS3/3/8.9-3S1	-	55	80	55	-	-	-	-	\approx 0.5
BDS3/3/8.9-4S2	-	-	-	65	-	100	110	-	\approx 0.5
BDS4.6/3/8.9-4S2	-	-	-	65	-	100	110	-	\approx 0.5

Table 5. Chip bead Z characteristics*

***Note:** Typical impedance values measured at 25°C with Agilent-4191A impedance analyzer. |Z|_{min} is -20% typical specified.

TYPE	Maximum Vdc	DC resistance	Isat*	Imax (A)	
	Volts	(m Ω)	mA	25°	125°
BDS3/1.8/5.3-3S1	60	< 0.6	\approx 300	10	8.5
BDS3/1.8/5.3-4S2	60	< 0.6	\approx 500	10	8.5
BDS3/3/4.6-3S1	60	< 0.6	\approx 300	10	8.5
BDS3/3/4.6-4S2	60	< 0.6	\approx 1000	10	8.5
BDS3/3/4.6-3S5	60	< 0.6	\approx 1500	10	8.5
BDS3/3/4.6-4S60	60	< 0.6	\approx 500	10	8.5
BDS3/3/4.6-4S3	60	< 0.6	\approx 500	10	8.5
BDS3/3/8.9-3S1	80	< 1.0	\approx 300	10	8.5
BDS3/3/8.9-4S2	80	< 1.0	\approx 1000	10	8.5
BDS4.6/3/8.9-4S2	80	< 1.0	\approx 1000	10	8.5

Table 6. Chip bead electrical characteristics*

***Note:** Isat is defined with DC bias value at which Z specification decreases around 50%.

4.2.4 PACKAGING AND ORDERING CODES

TYPE	PACKING QUANTITY [PCS / REEL]	ORDERING CODE [12 NC]	RoHS complaint
BDS3/1.8/5.3-3S1-Z	3000	43300305573_	yes
BDS3/1.8/5.3-4S2-Z	3000	43300305566_	yes
BDS3/3/4.6-3S5	3000	43300307237_	yes
BDS3/3/4.6-4S60	3000	43300307238-	yes
BDS3/3/4.6-4S3	3000	43300307239_	yes
BDS3/3/4.6-3S1-CZ	3000	43300305561_	yes
BDS3/3/4.6-4S2-Z	3000	43300305550_	yes
BDS3/3/8.9-3S1-CZ	2800	43300305564_	yes
BDS3/3/8.9-4S2-Z	2800	43300305547_	yes
BDS4.6/3/8.9-4S2-Z	2400	43300305551_	yes
BDS3/1.8/5.3-3S1	3000	43300303685_	no*
BDS3/1.8/5.3-4S2	3000	43300303682_	no*
BDS3/3/4.6-4S2	3000	43300303629_	no*
BDS3/3/8.9-4S2	2800	43300303630_	no*
BDS4.6/3/8.9-4S2	2400	43300303652_	no*

The chip beads are delivered taped and reeled, ready for use in automatic mounting machines. The packaging is according to IEC 286-A and EIA 481-A

Table 7. Chip bead packaging quantities and ordering code

* Check disponibility. Upon request

4.2.5 BLISTER TAPE AND REEL DIMENSIONS

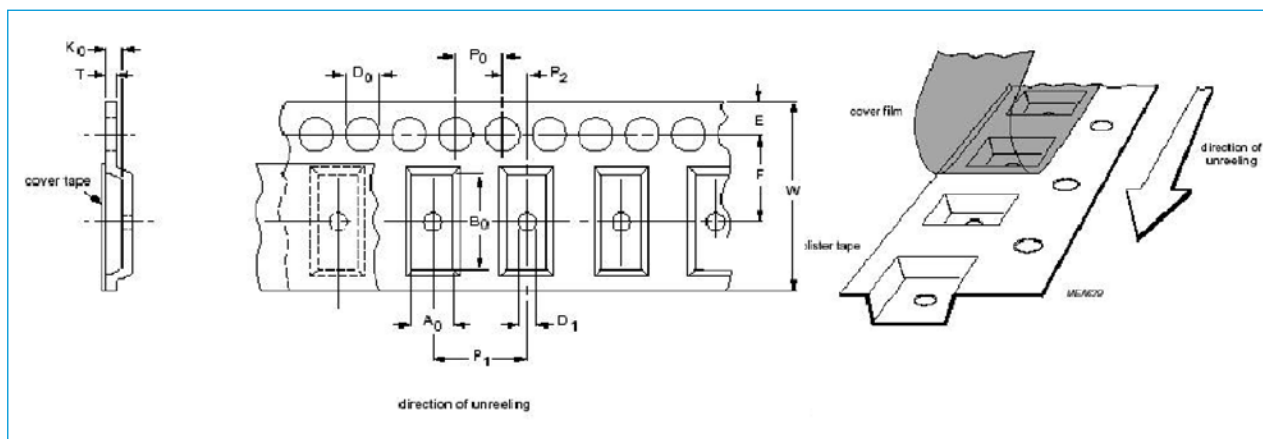

Figure 5. Blister tape

SIZE	DIMENSIONS (mm)			
	BDS3/1.8/5.3	BDS3/3/4.6	BDS3/3/8.9	BDS4.6/3/8.9
A0	3.25 ± 0.1	3.45 ± 0.1	3.45 ± 0.1	3.25 ± 0.1
B0	5.85 ± 0.1	5.1 ± 0.1	9.4 ± 0.1	9.4 ± 0.1
K0	2.0 ± 0.1	3.1 ± 0.1	3.1 ± 0.1	3.1 ± 0.1
T	0.3 ± 0.05	0.25 ± 0.05	0.35 ± 0.1	0.3 ± 0.05
W	12.0 ± 0.3	12.0 ± 0.3	16.0 ± 0.3	16.0 ± 0.3
E	1.75 ± 0.1	1.75 ± 0.1	1.75 ± 0.3	1.75 ± 0.1
F	5.5 ± 0.05	5.5 ± 0.05	7.5 ± 0.1	7.5 ± 0.05
D0	1.5 + 0.1	1.5 + 0.1	1.5 ± 0.1	1.5 + 0.1
D1	> 1.5	> 1.5	1.5 + 0.1	> 1.5
P0	4.0 ± 0.1	4.0 ± 0.1	4.0 ± 0.1	4.0 ± 0.1
P1	8.0 ± 0.1	8.0 ± 0.1	8.0 ± 0.1	8.0 ± 0.1
P2	2.0 ± 0.1	2.0 ± 0.05	2.0 ± 0.1	2.0 ± 0.1

Table 8. Physical dimensions of blister tape (in millimeters)

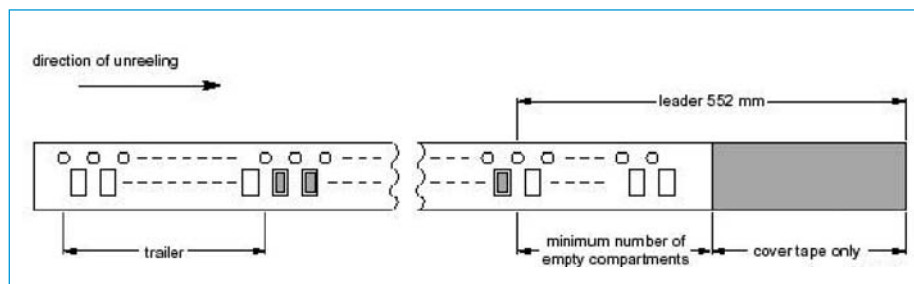

Figure 6. Tape leader and trailer*

Note*: trailer contains 75 empty compartments minimum (secured with tape)
 Leader: length of leader is 500 mm minimum and covered with covertape

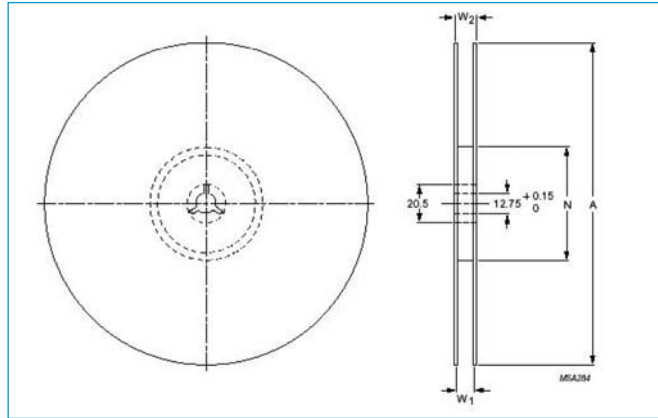

Figure 7. Reel dimensions (in millimeters)

SIZE	DIMENSIONS (mm)			
	A	N	W1	W2
12	330	100 ± 0.5	12.4	≤ 16.4
16	330	100 ± 0.5	16.4	≤ 20.4

Table 9. Physical dimensions of reel (in millimeters)

4.2.6 RECOMMENDED SOLDER LANDS

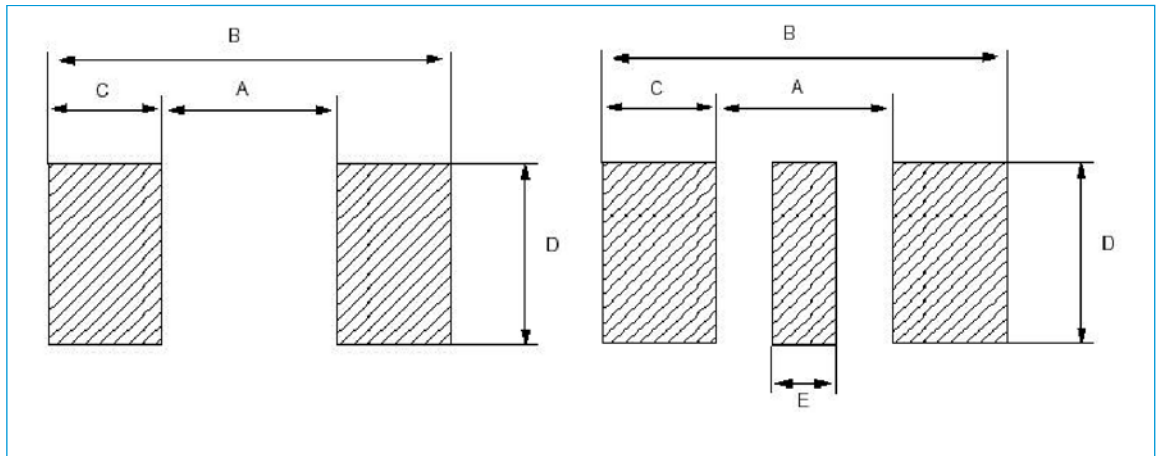

Figure 8a. Solder lands reflow soldering

Figure 8b. Solder lands wave soldering

SHAPE	Reflow soldering				Wave soldering				
	A	B	C	D	A	B	C	D	E
BDS3/3/8.9	7.0	10.8	1.9	3.3	6.0	12.2	3.1	3.0	2.5
BDS3/3/4.6	2.8	6.4	1.8	3.3	2.0	6.4	2.2	3.0	0.8
BD4.6/3/8.9	7.0	10.8	1.9	3.3	6.0	12.2	3.1	3.0	2.5
BDS3/1.8/5.3	2.8	7.2	2.2	3.3	2.0	7.2	2.6	3.0	0.8

Table 10. Dimensions of solder lands (in millimeters)
For recommended temperature/time profiles see 8.0 soldering curves

4.2.7 TYPICAL IMPEDANCE CURVES

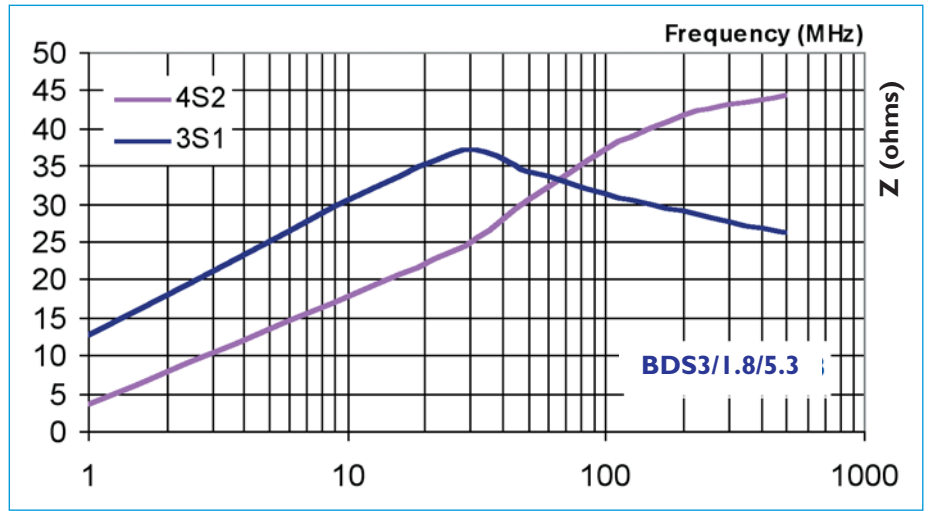

Figure 9. Z graph BDS3/1.8/5.3-3S1 and BDS3/1.8/5.3-4S2

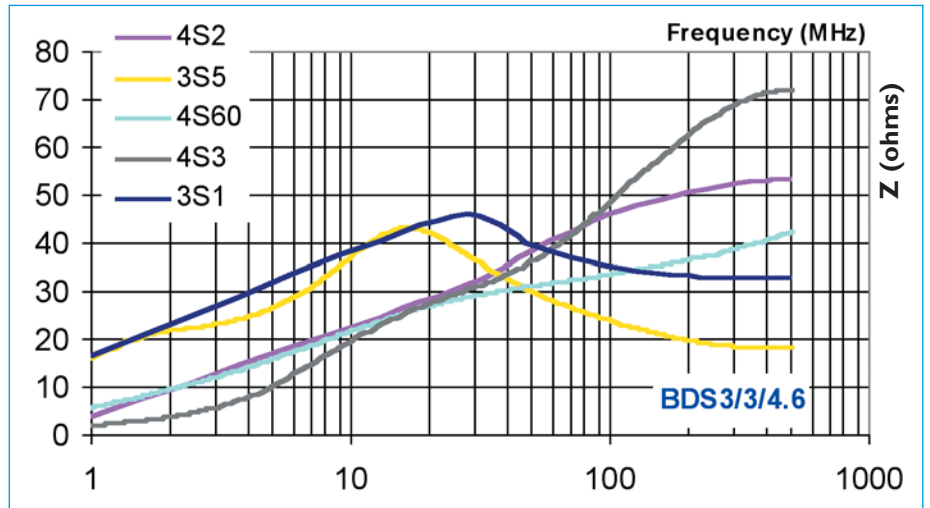

Figure 10. Z graph BDS3/3/4.6 in 3S1, 4S2, 3S5, 4S60 and 4S3 materials

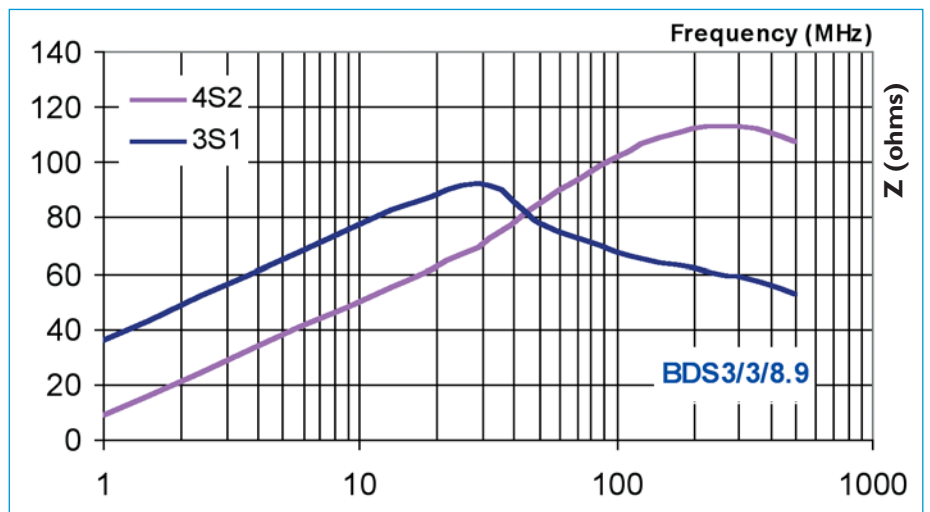

Figure 11. Z graph BDS3/3/8.9-3S1 and BDS3/3/8.9-4S2

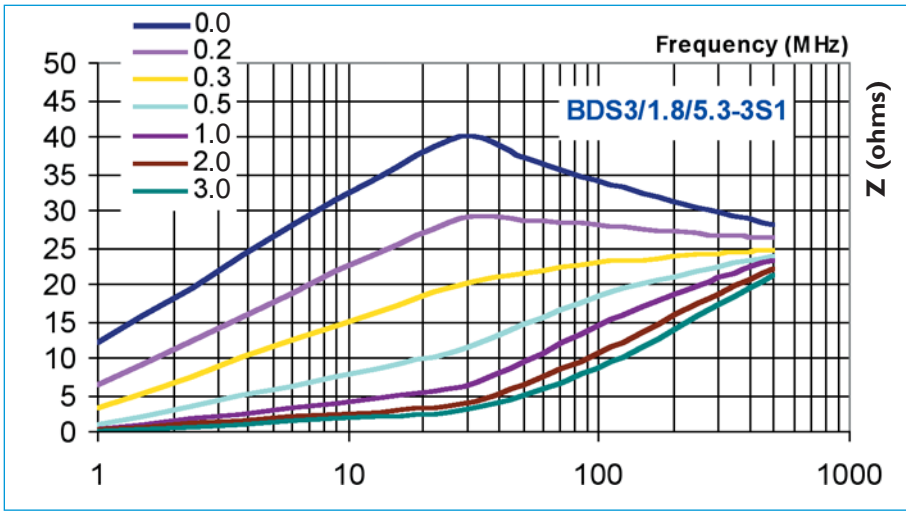

Figure 12. Impedance vs. frequency for BDS3/1.8/5.3-3S1 under DC-premagnetization

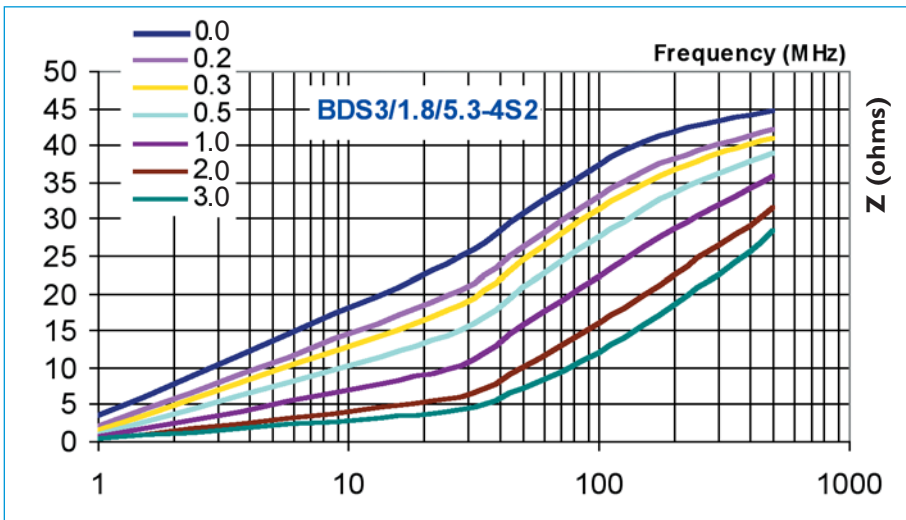

Figure 13. Impedance vs. frequency for BDS3/1.8/5.3-4S2 under DC-premagnetization

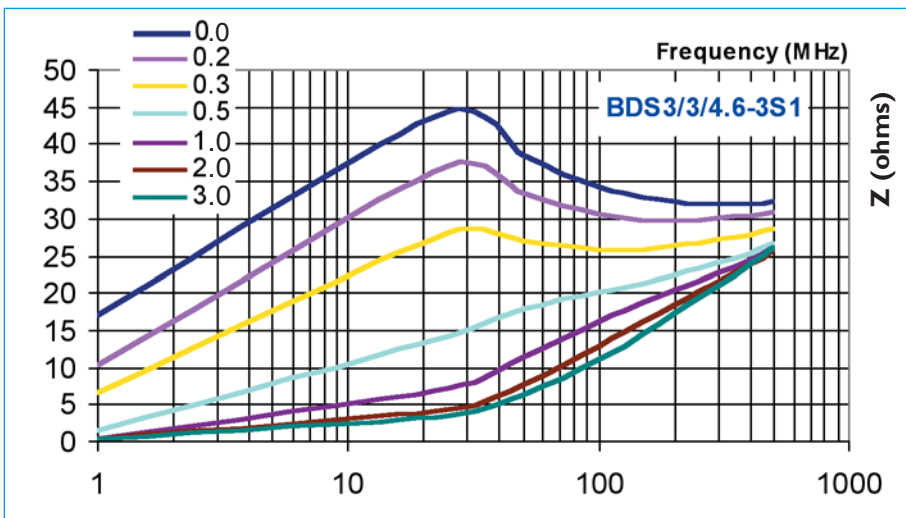

Figure 14. Impedance vs. frequency for BDS3/3/4.6-3S1 under DC-premagnetization

Figure 15. Impedance vs. frequency for BDS3/3/4.6-4S2 under DC-premagnetization

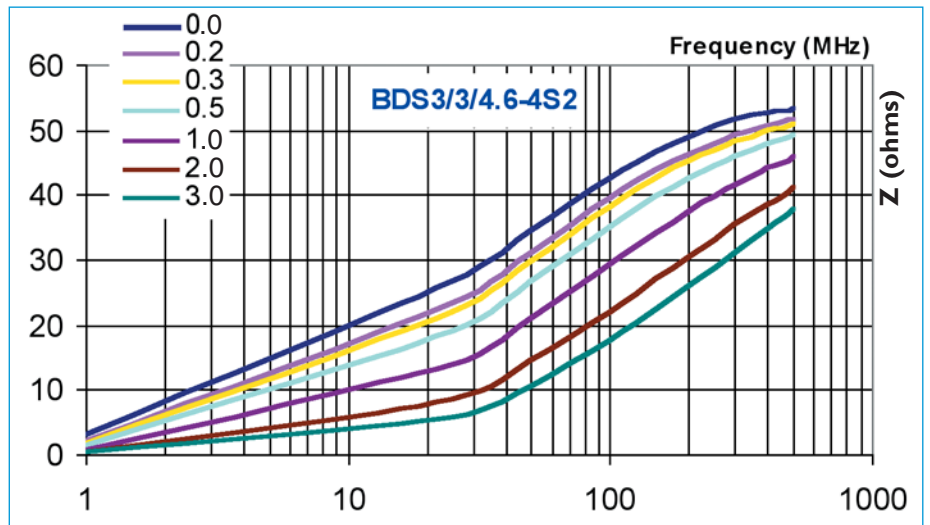

Figure 16. Impedance vs. frequency for BDS3/3/4.6-4S60 under DC-premagnetization

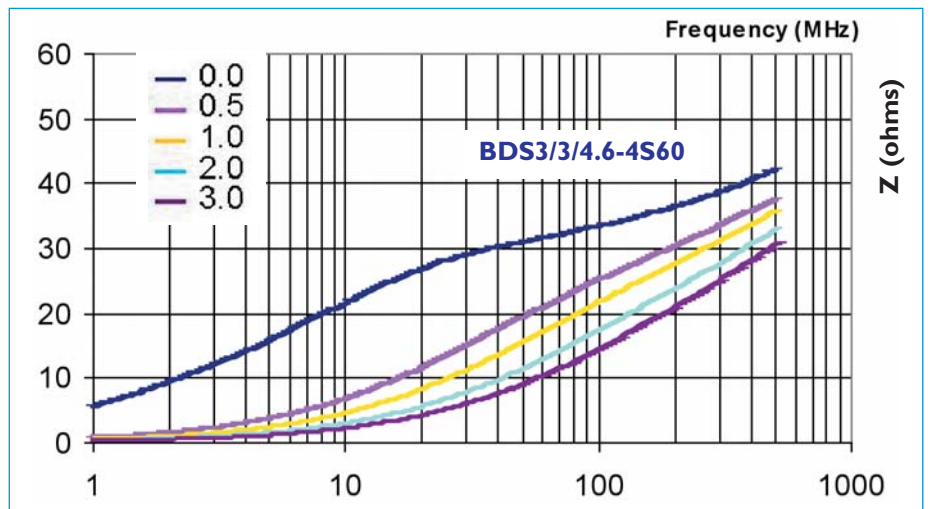
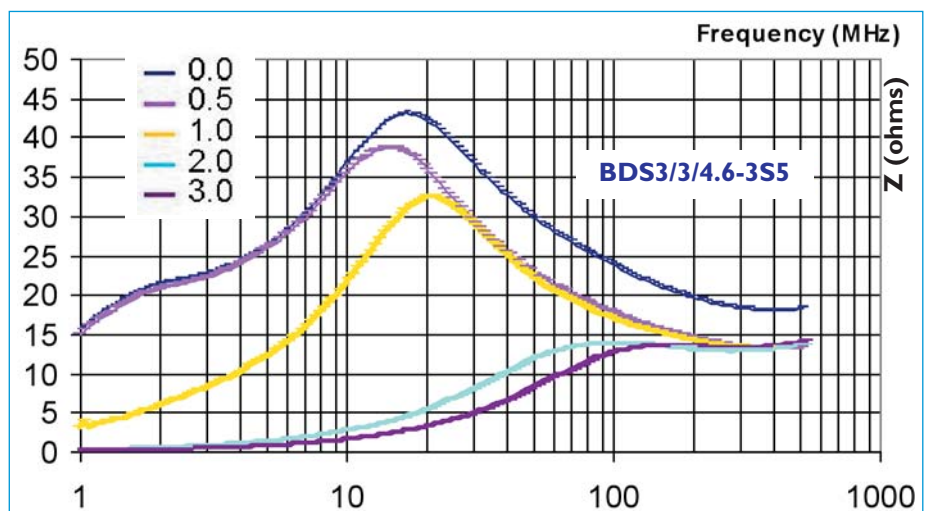

Figure 17. Impedance vs. frequency for BDS3/3/4.6-3S5 under DC-premagnetization



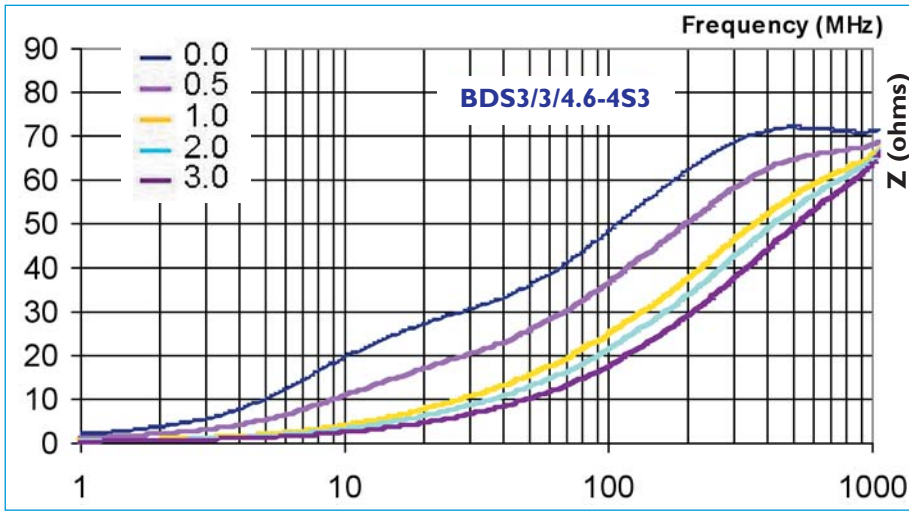

Figure 18. Impedance vs. frequency for BDS3/3/4.6-4S3 under DC-premagnetization

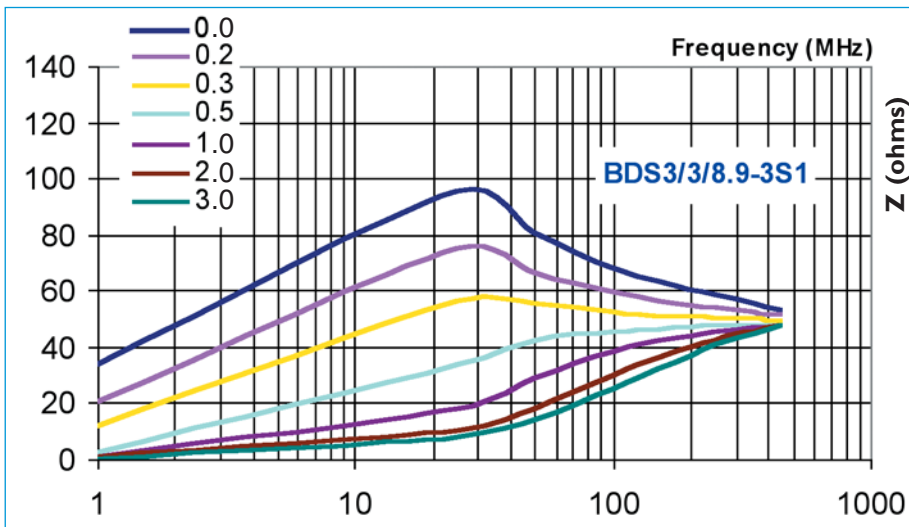

Figure 19. Impedance vs. frequency for BDS3/3/8.9-3S1 under DC-premagnetization

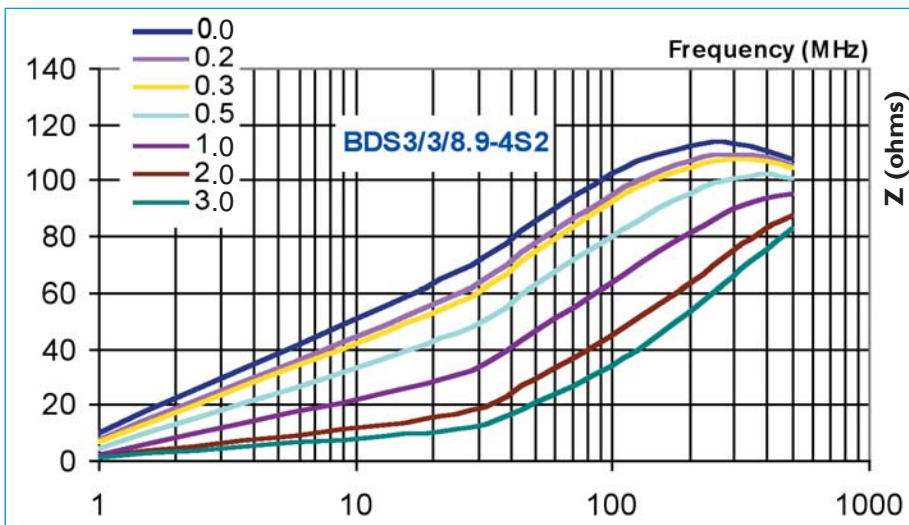

Figure 20. Impedance vs. frequency for BDS3/3/8.9-4S2 under DC-premagnetization

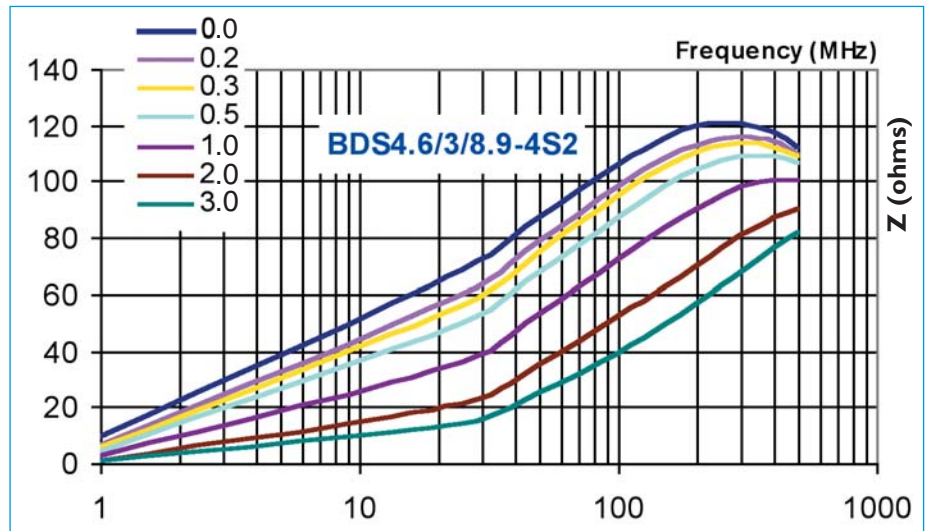
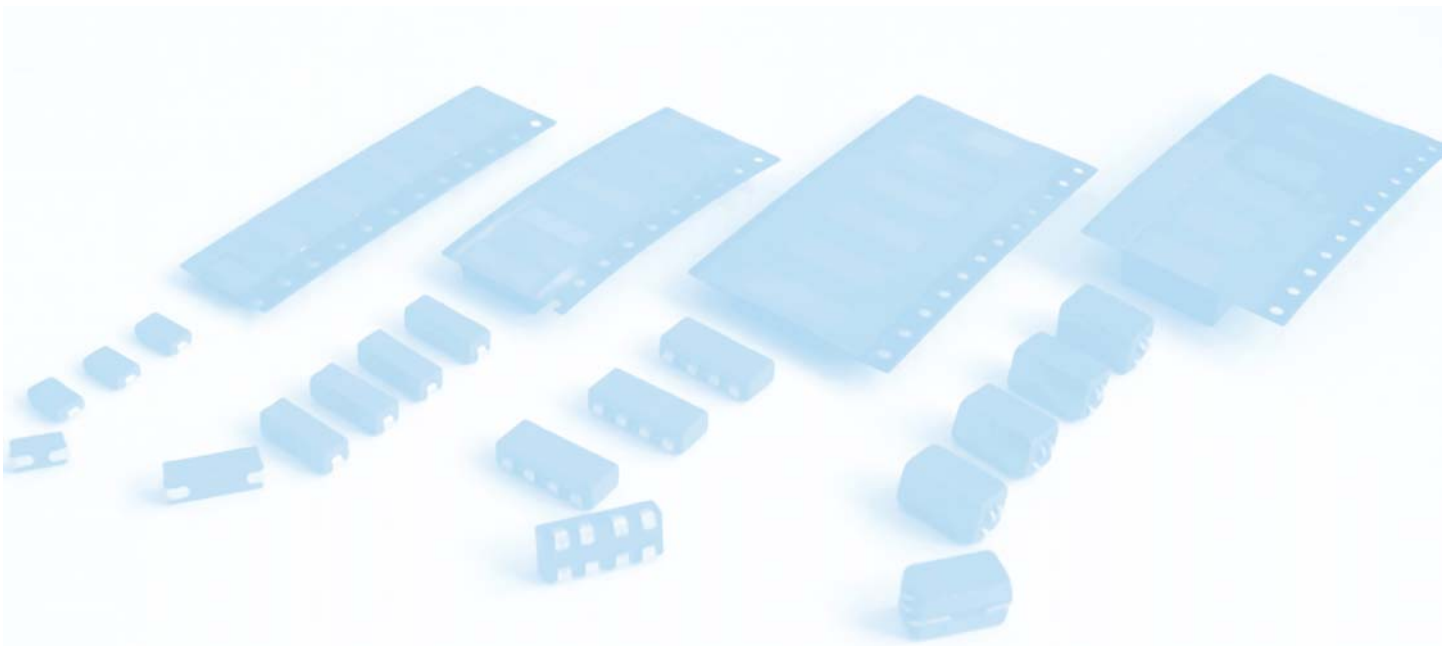
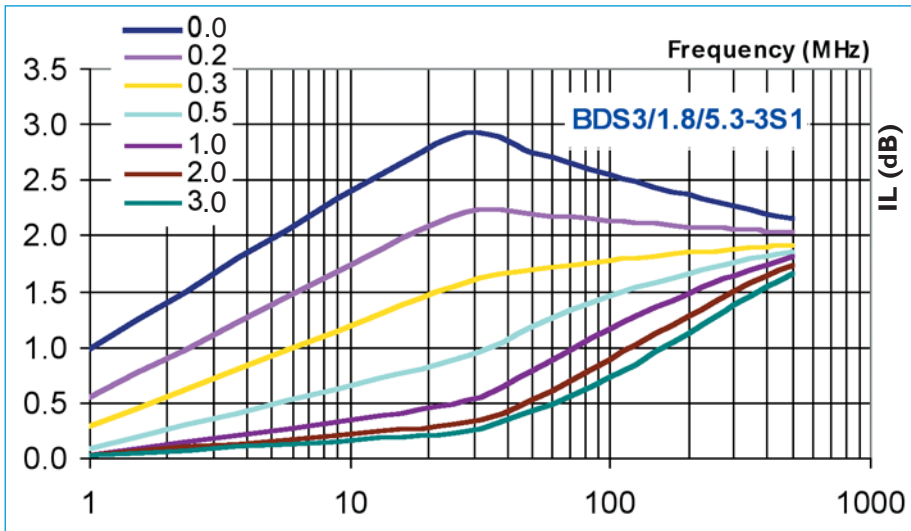

Figure 21. Impedance vs. frequency for BDS4.6/3/8.9-4S2 under DC-premagnetization





4.2.7 TYPICAL DAMPING CURVES

Figure 22. Attenuation vs. frequency for BDS3/1.8/5.3-3S1 under DC-premagnetization

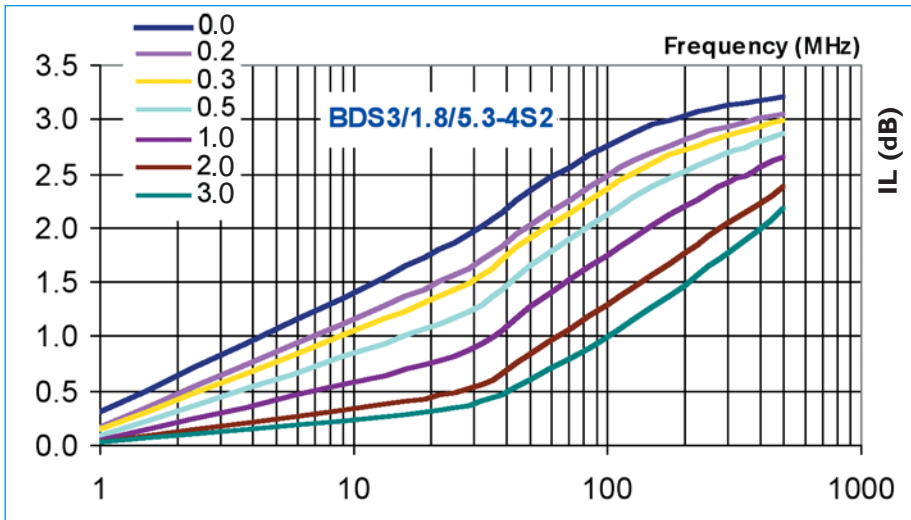

Figure 23. Attenuation vs. frequency for BDS3/1.8/5.3-4S2 under DC-premagnetization

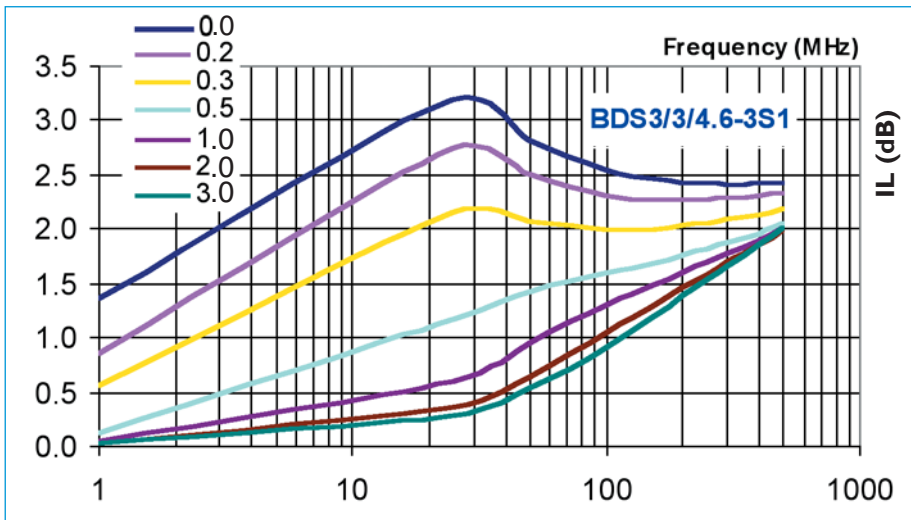

Figure 24. Attenuation vs. frequency for BDS3/3/4.6-3S1 under DC-premagnetization

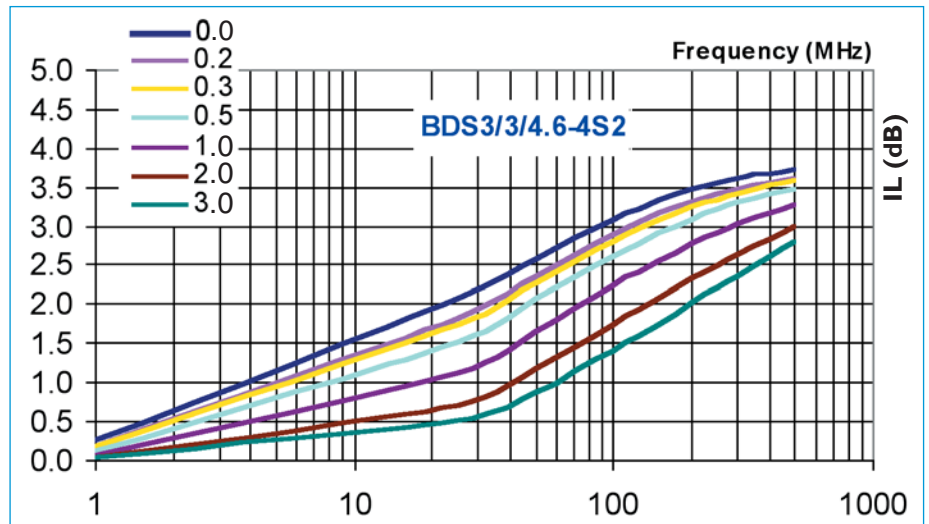

Figure 25. Attenuation vs. frequency for BDS3/3/4.6-4S2 under DC-premagnetization

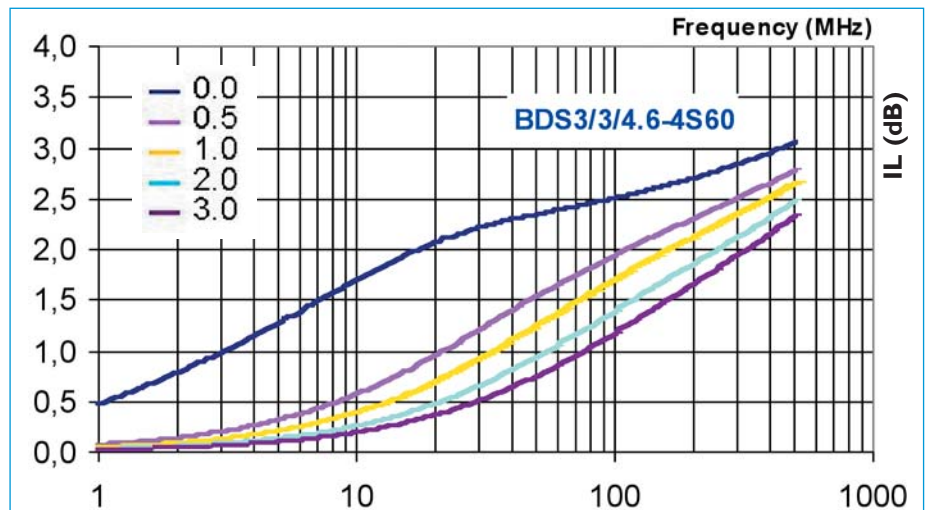

Figure 26. Attenuation vs. frequency for BDS3/3/4.6-4S60 under DC-premagnetization

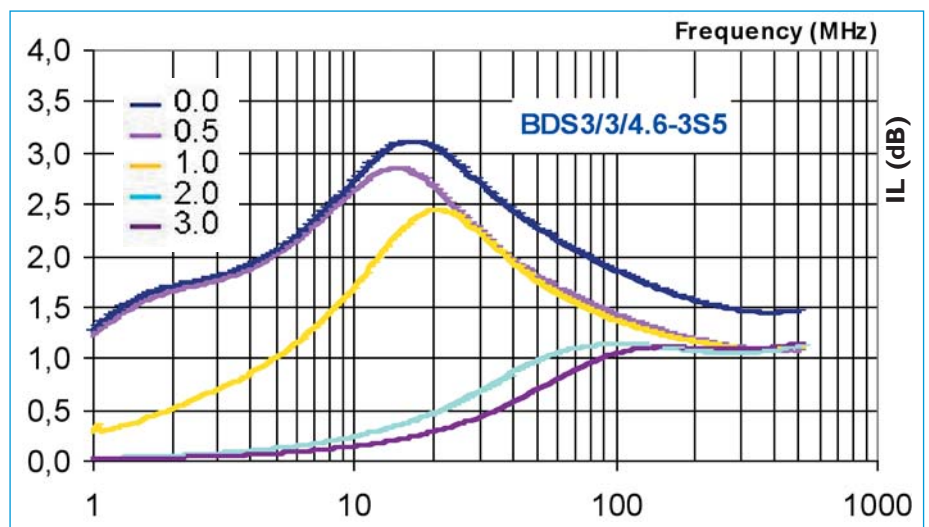

Figure 27. Attenuation vs. frequency for BDS3/3/4.6-3S5 under DC-premagnetization

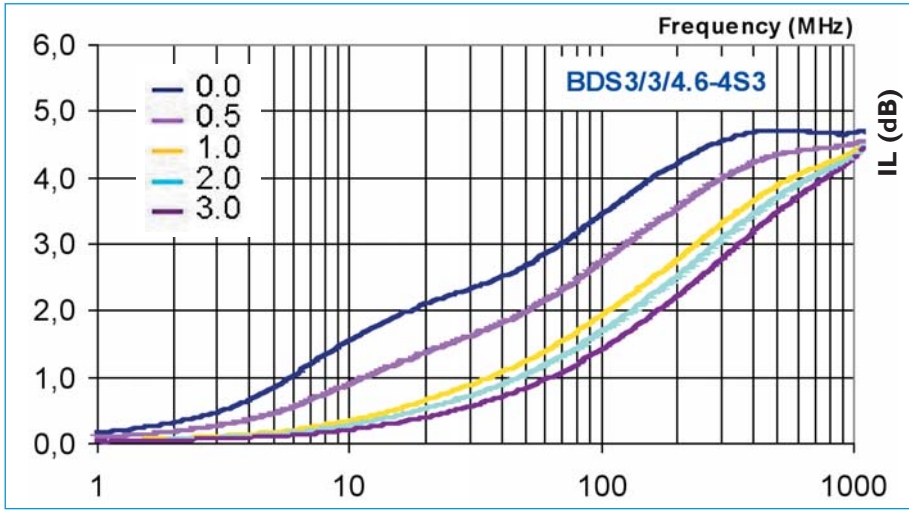

Figure 28. Attenuation vs. frequency for BDS3/3/4.6-4S3 under DC-premagnetization

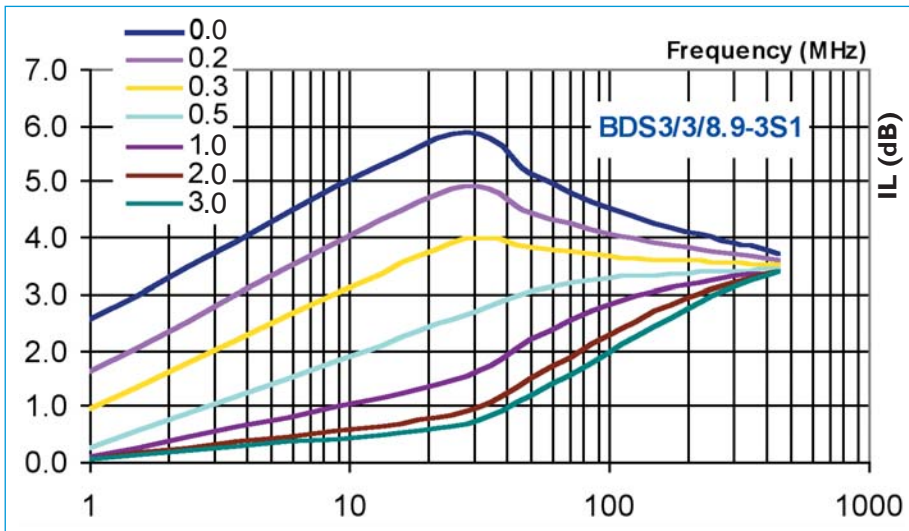

Figure 29. Attenuation vs. frequency for BDS3/3/8.9-3S1 under DC-premagnetization

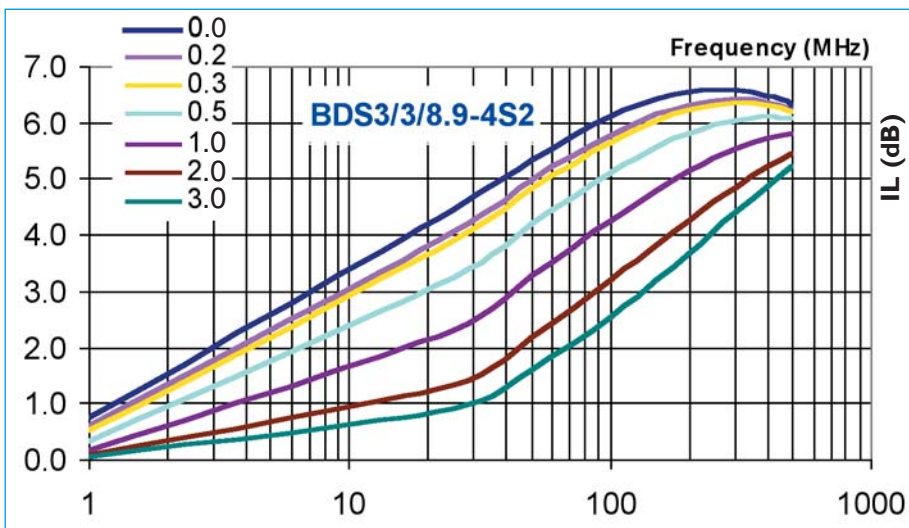

Figure 30. Attenuation vs. frequency for BDS3/3/8.9-4S2 under DC-premagnetization

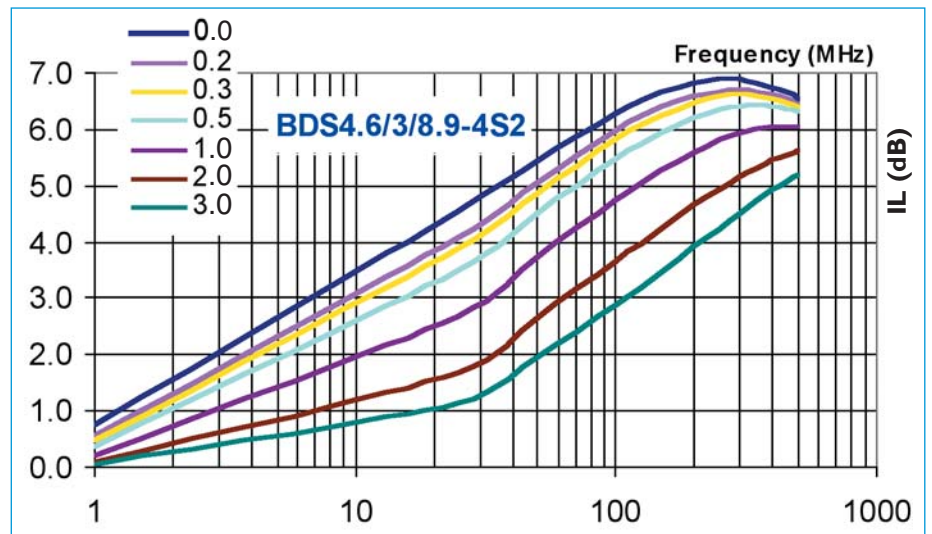
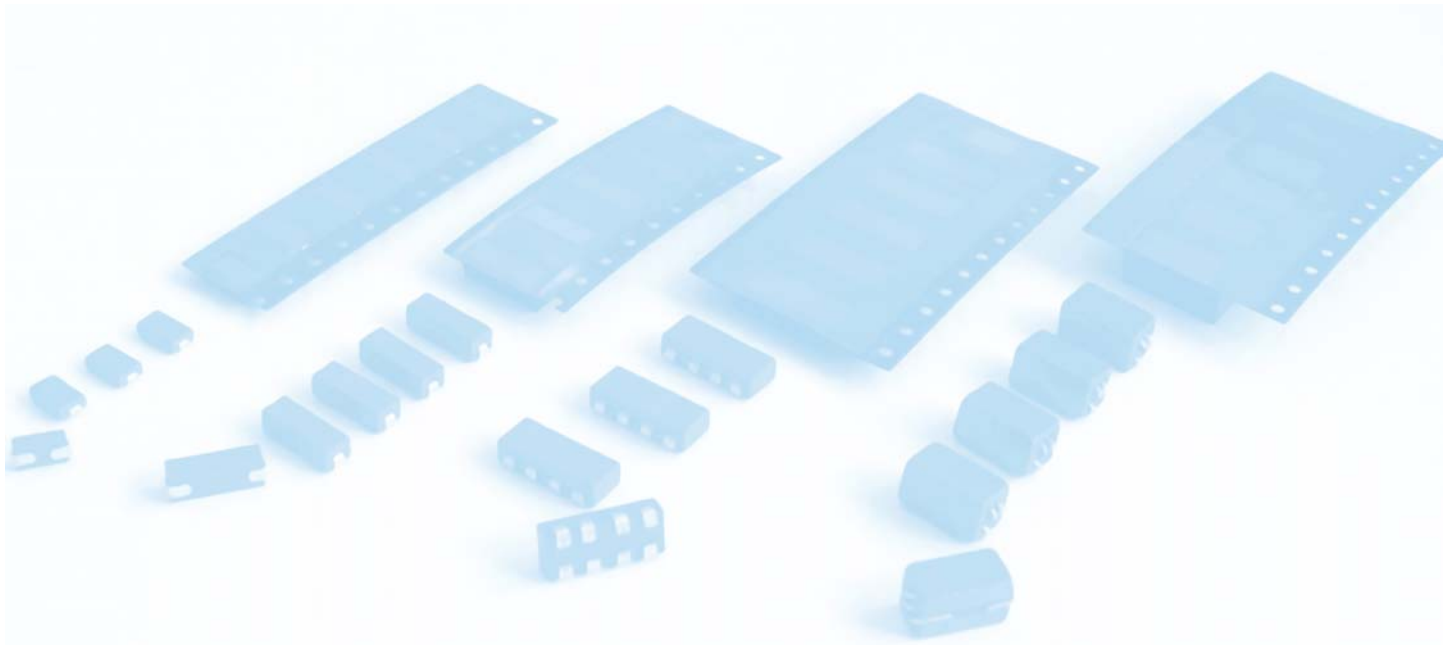

Fig 31. Attenuation vs. frequency for BDS4.6/3/8.9-4S2 under DC-premagnetization



5.0 OPERATING PRINCIPLE OF SMD COMMON MODE CHOKES

Interference propagating via supply or signal lines can be suppressed by placing a high impedance in series. This can be provided by a ferrite inductor. However, saturation by the supply current can be a problem. Remedies are a low permeability material or a gapped / open magnetic circuit.

The disadvantage is the large number of turns required to achieve the required inductance, leading to high copper losses. With standard suppression methods in a signal path, the wanted signal is often suppressed along with the interference, and in many modern applications (EDP for instance) this leads to unacceptable loss of signal. This can be overcome with current compensation, based on the fact that supply or signal currents in both lines are opposite and have equal magnitude.

In Ferroxcube new interference-suppression beads, a pair of conductors within a single soft-ferrite block are connected along their lengths by an air gap. Common-mode signals - interference signals passing in the same direction along the input and output channels of a device (an IC for instance) - serve to reinforce the magnetic flux around both conductor, and are therefore attenuated. In contrast, the wanted signal passing along the input and output channel serves to cancel the flux around the conductors and therefore passes unattenuated.

5.1 PRODUCT APPLICATION

These common mode chokes are available in 4 sizes in 4S2 material with 2 different winding configurations. In combination with appropriate tracks on the PCB the products can also serve as:

- Multi-Turn Choke
- Transformer

The main application areas for the SMD common mode choke can be found in e.g.:

- Electronic data processing
- Telecommunication
- Consumer electronics
- Domestic appliances

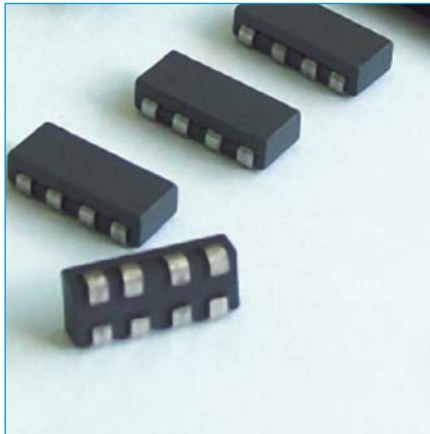

Figure 32. SMD Common Mode Choke

5.2 PRODUCT SPECIFICATION

5.2.1 GENERAL SPECIFICATION

FEATURES:

- Resistant to mechanical shocks and pressure
- High resistivity material
- Low tolerances of mechanical dimensions enable automatic mounting
- Flat sides to improve handling by automatic placement machines
- Low leakage inductance
- Suitable for different functions, depending on PCB connections

APPLICATIONS:

- EMI suppression
- Supply line filtering
- Data line filtering

TYPE DESCRIPTION:

e.g. CMS2-5.6/3/4.8-4S2-Z
(1) (2)(3)(4)(5) (6) (7)

- (1) Product type (CMS=Common Mode Surface mountable choke)
- (2) Number of strips
- (3) Width nominal (in mm)
- (4) Height maximum including wire (in mm)
- (5) Length nominal including wire (in mm)
- (6) Material grade
- (7) -Z lead-free version*

***Note:** Not lead-free old version available depending on stock. All new codes are leadfree (not -Z included on type description).

ORDERING CODE (I2 NC):

e.g. 433003055761

The first 11 digits of the I2 NC are sufficient to order the desired SMD common mode choke. SMD common mode chokes are delivered taped and reeled, ready for use on automatic mounting machines.

5.2.2 SHAPE AND DIMENSIONS

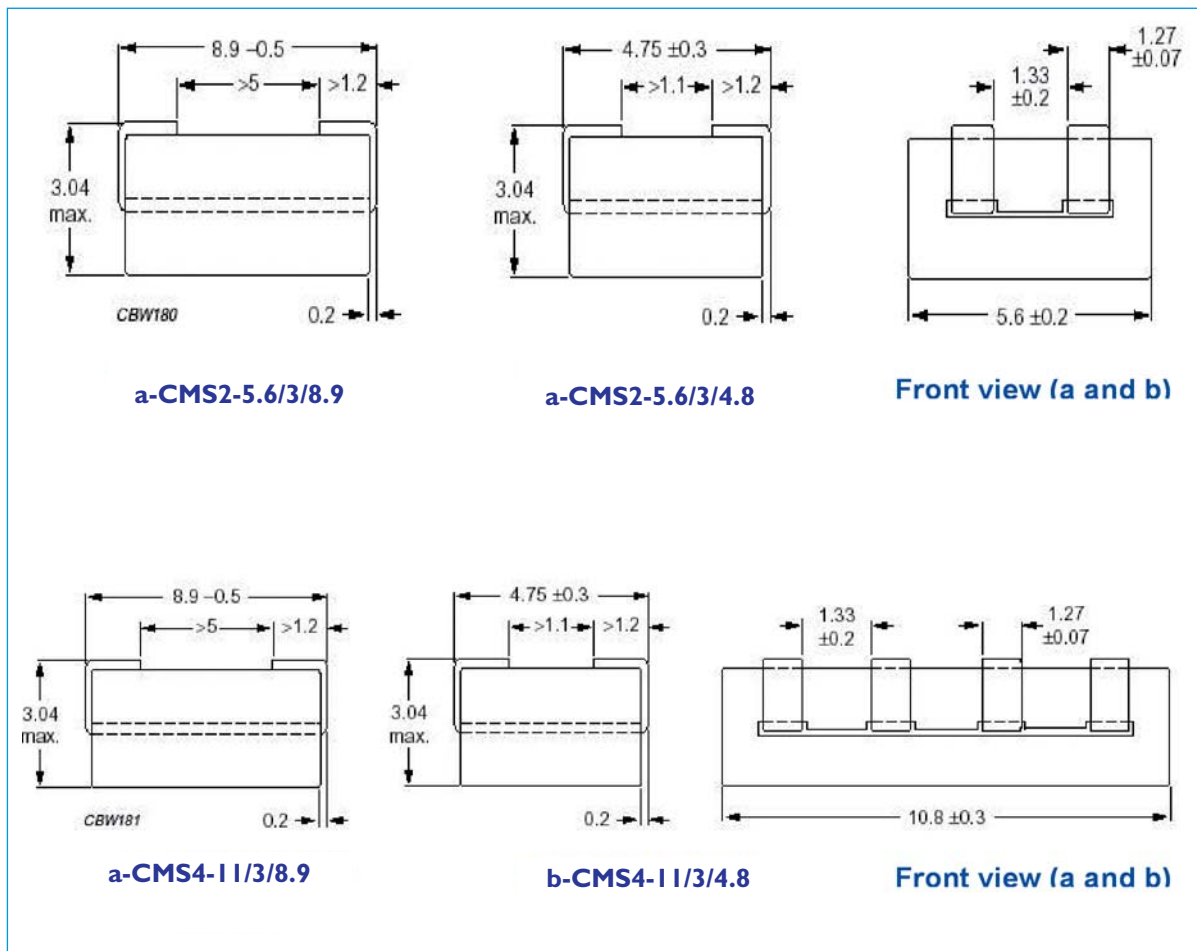

Figure 33. SMD common mode chokes dimensions (in millimeters)

5.2.3 ELECTRICAL CHARACTERISTICS

TYPE	Remark	IMPEDANCE [Ω] AT FREQUENCY [MHz]			Mass (g)
		30	100	300	
CMS2-5.6/3/4.8-4S2	-	23	35	50	≈ 0.3
CMS2-5.6/3/8.9-3S4	-	45	65	-	≈ 0.3
CMS2-5.6/3/8.9-4S2	-	38	60	85	≈ 0.3
CMS4-11/3/4.8-4S2	Inner channel	13	23	42	≈ 0.6
	Outer channel	13	23	42	
CMS4-11/3/8.9-4S2	Inner channel	23	45	82	≈ 0.6
	Outer channel	27	58	97	

Table 11. SMD common mode chokes electrical characteristics*

***Note:** Typical impedance values measured at 25°C with Agilent-4191A impedance analyzer. $|Z|_{min}$ is -20% typical specified.

TYPE	Maximum Vdc	DC resistance (mΩ)	Imax (A)	
	Volts		25°	125°
CMS2-5.6/3/4.8-4S2	60	< 0.6	10	8.5
CMS2-5.6/3/8.9-3S4	60	< 0.6	10	8.5
CMS2-5.6/3/8.9-4S2	60	< 0.6	10	8.5
CMS4-11/3/4.8-4S2	60	< 0.6	10	8.5
CMS4-11/3/8.9-4S2	60	< 0.6	10	8.5

Table 12. SMD Common mode Choke electrical characteristics

5.2.4 PACKAGING AND ORDERING CODES

The SMD Common mode chokes are delivered taped and reeled, ready for use in automatic mounting machines. The packaging is according to IEC 286-A and EIA 481-A

TYPE	PACKING QUANTITY [PCS / REEL]	ORDERING CODE [12 NC]	RoHS
CMS2-5.6/3/8.9-4S2-Z	2500	43300305576_	yes
CMS2-5.6/3/8.9-3S4-Z	2500	43300305575_	yes
CMS2-5.6/3/4.8-4S2-Z	2500	43300305574_	yes
CMS4-11/3/4.8-4S2-Z	2500	43300305565_	yes
CMS4-11/3/8.9-4S2-Z	2500	43300305577-	yes
CMS2-5.6/3/8.9-4S2	2500	43300304630_	no*
CMS2-5.6/3/8.9-3S4	2500	43300305575_	no*

Table 13. SMD common mode chokes packaging quantities and ordering code

* Check disponibility. Upon request.

5.2.5 BLISTER TAPE AND REEL DIMENSIONS

SIZE	DIMENSIONS (mm)			
	CMS2-5.6/3/4.8	CMS2-5.6/3/8.9	CMS4-11/3/4.8	CMS4-11/3/8.9
A0	5.26	5.99	5.23	10.13
B0	6.07	9.09	11.18	11.56
K0	3.18	3.18	4.5	4.5
T	0.3	0.33	0.34	0.36
W	12.0	16.0	24.0	24.0
E	1.75	1.75	1.75	1.75
F	5.5	7.5	11.75	11.5
D0	1.5	1.5	1.5	1.5
D1	> 1.5	> 1.5	> 1.5	> 1.5
P0	4.0	4.0	4.0	4.0
P1	8.0	8.0	8.0	16.0
P2	2.0	2.0	2.0	2.0

Table 14. Physical dimensions of blister tape (in millimeters)*

*Note: Figure 5 for reference detailed dimensions.

SIZE	DIMENSIONS (mm)			
	A	N	W1	W2
12	330	100 ± 0.5	12.4	≤16.4
16	330	100 ± 0.5	16.4	≤20.4
24	330	100 ± 0.5	16.4	≤28.4

Table 15. Physical dimensions of reel (in millimeters)*

*Note: Figure 7 for reference detailed dimensions.

5.2.6 RECOMMENDED SOLDER LANDS

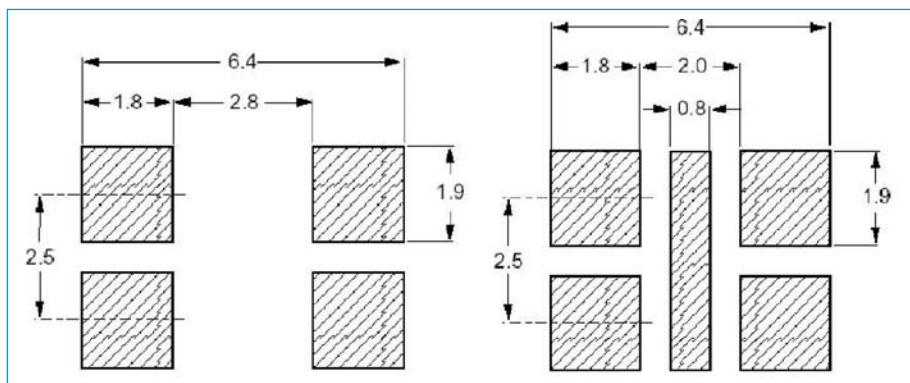

Figure 34a.

Figure 34b.

Figure 34a. Solder lands for reflow soldering of CMS2-5.6/3/4.8

Figure 34b. Solder lands for wave soldering of CMS2-5.6/3/4.8

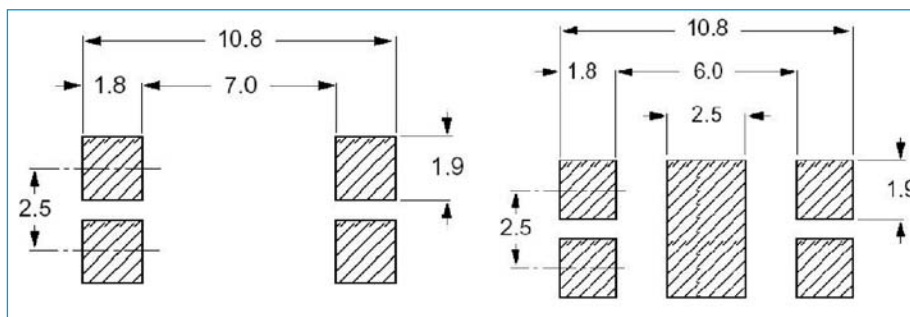

Figure 35a.

Figure 35b.

Figure 35a. Solder lands for reflow soldering of CMS2-5.6/3/8.9

Figure 35b. Solder lands for wave soldering of CMS2-5.6/3/8.9

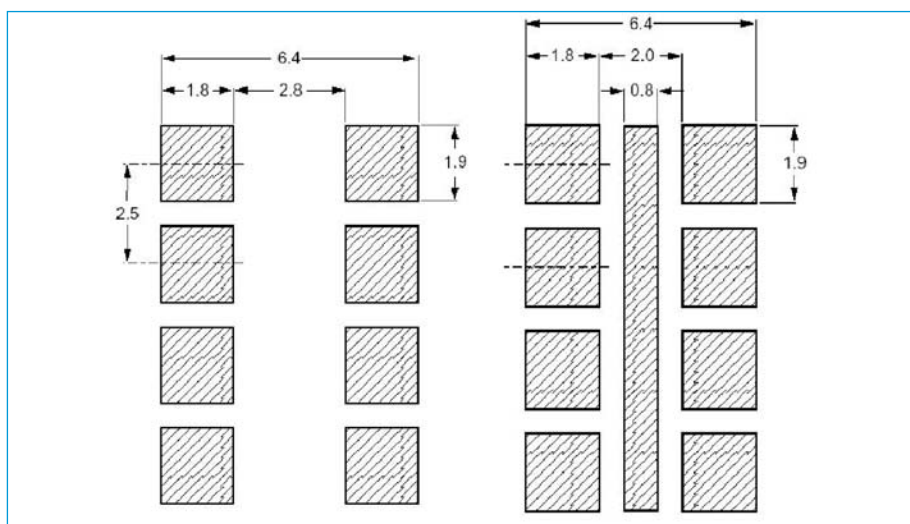
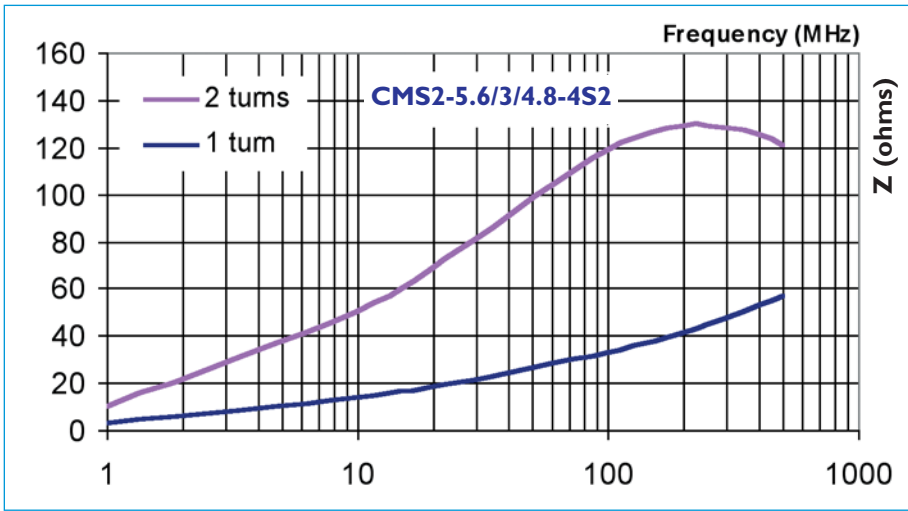

Figure 36a.

Figure 36b.

Figure 36a. Solder lands for reflow soldering of CMS4-11/3/4.8

Figure 36b. Solder lands for wave soldering of CMS4-11/3/4.8



5.2.7 TYPICAL IMPEDANCE CURVES

Figure 37. Z graph CMS2-5.6/3/4.8-4S2 (1 and 2 turns)

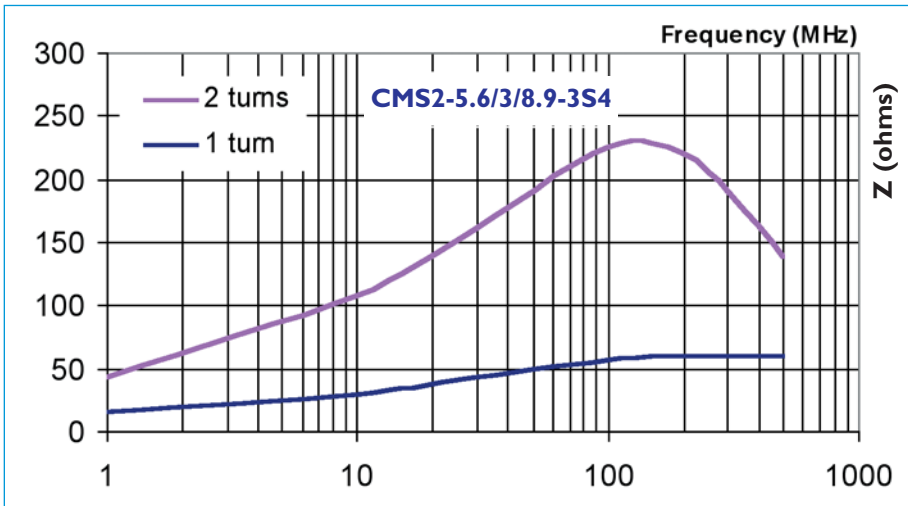

Figure 38. Z graph CMS2-5.6/3/8.9-3S4 (1 and 2 turns)

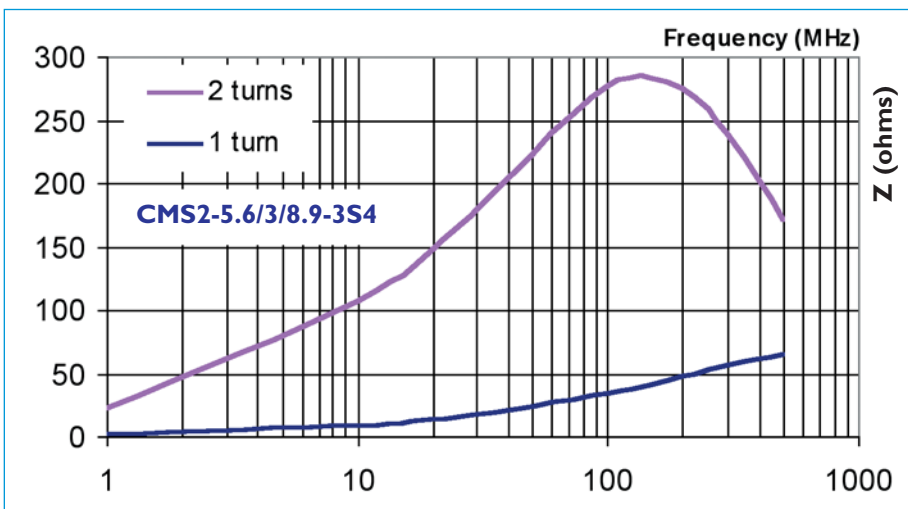

Figure 39. Z graph CMS2-5.6/3/8.9-3S4 (1 and 2 turns)

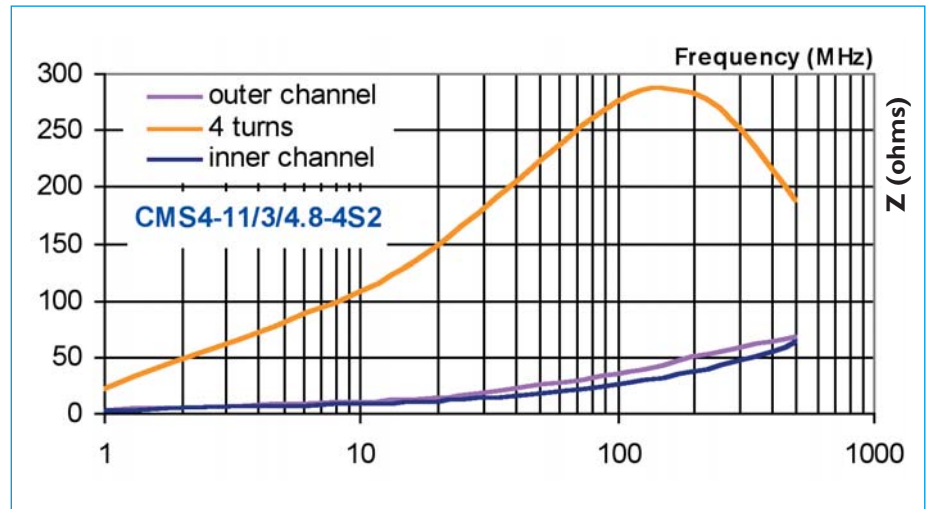

Figure 40. Z graph CMS4-11/3/4.8-4S2

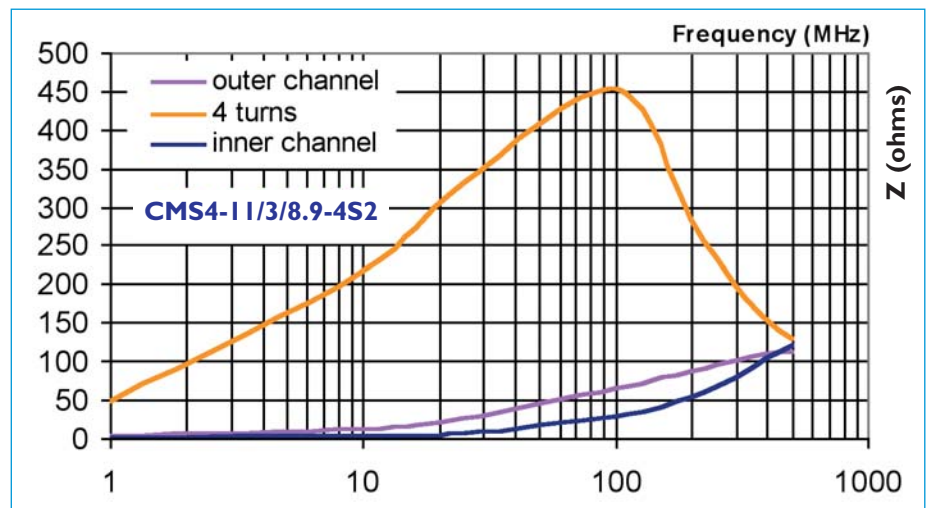

Figure 41. Z graph CMS4-11/3/8.9-4S2

6.0 OPERATING PRINCIPLE OF SMD WIDE BAND CHOKES

SMD wide-band chokes are an alternative to a SMD bead when more impedance or damping is required. The design of this product is based on our well-known range of through-hole wide-band chokes. In these products the conductor wire is wound through holes in a multi-hole ferrite core, thus separating them physically and reducing coil capacitance. The result is a high impedance over a wide frequency range, a welcome feature for many interference problems.

The present SMD design preserves the excellent properties and reliability of the original wide-band chokes by keeping the number of electrical interfaces to an absolute minimum.

6.1 PRODUCT APPLICATION

SMD wide-band chokes are available in 3S4 and 4B1 material with different winding configurations offering Z values according for each needed.

As SMD beads and common mode chokes, the SMD wide-bands chokes are used in main electronics appliances:

- Electronic data processing
- Telecommunication
- Consumer electronics
- Domestic appliances

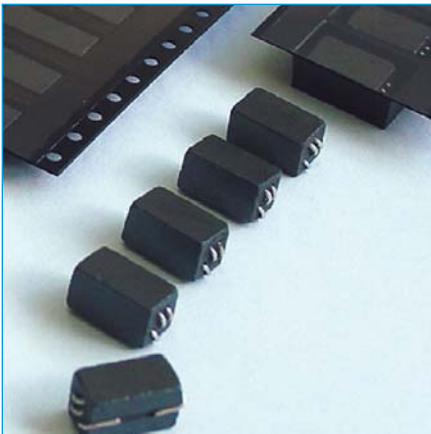

Figure 42. SMD wide-band chokes

6.2 PRODUCT SPECIFICATION

6.2.1 GENERAL SPECIFICATION

FEATURES:

- Low leakage inductance due to closed magnetic circuit
- Small mechanical tolerances enable automatic mounting
- Flat sides to improve handling by automatic placement machines
- Reliability of simple design
- Single wire construction without extra electrical interfaces
- Resistant to mechanical shocks and pressure
- Resistant to thermal mismatch because of flexible wire connections

APPLICATIONS:

- EMI suppression
- Damping of parasitic oscillations

APPLICABLE MATERIALS:

- 3S4 covers medium frequencies up to 300 MHz
- 4B1 covers higher frequencies up to 1000 MHz

TYPE DESCRIPTION:

e.g. WBS2.5-5/4.8/10-4B1-Z
(1) (2) (3)(4) (5)(6) (7)

- (1) Product type (WBS=Wide Band choke for Surface mounting)
- (2) Number of turns
- (3) Width nominal (in mm)
- (4) Height maximum including wire (in mm)
- (5) Length nominal including wire (in mm)
- (6) Material grade
- (7) Lead-free version*

***Note:** Not lead-free old version available depending on stock. All new codes are leadfree (not -Z included on prime name)

ORDERING CODE (I2 NC):

e.g. 433003041991

The first 11 digits of the I2 NC are sufficient to order the desired SMD wide band choke. SMD wide band chokes are delivered taped and reeled, ready for use on automatic mounting machines.

6.2.2 SHAPE AND DIMENSIONS

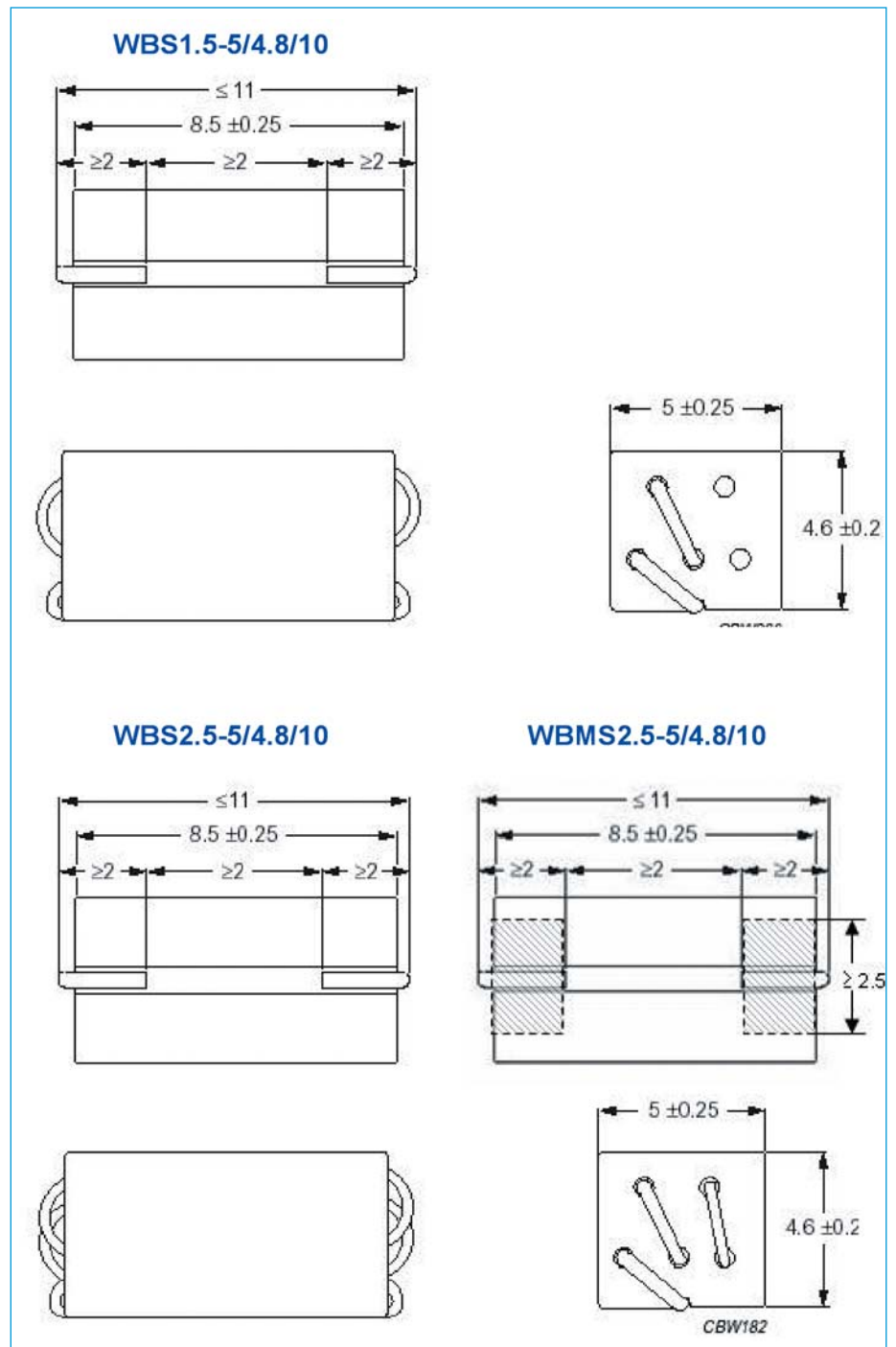

Figure 43. SMD wide-band chokes dimensions (in millimeters)

6.2.3 ELECTRICAL CHARACTERISTICS

TYPE	IMPEDANCE [Ω] AT FREQUENCY [MHz]					Mass (g)
	10	25	50	100	300	
WBS1.5-5/4.8/10-3S4	230	-	400	430	-	\approx 0.9
WBS1.5-5/4.8/10-4BI	-	275	-	500	350	\approx 0.9
WBS2.5-5/4.8/10-3S4	300	-	625	600	-	\approx 0.9
WBS2.5-5/4.8/10-4BI	-	485	-	850	350	\approx 0.9

Table 16. SMD wide-band chokes electrical characteristics.

TYPE	Maximum Vdc Volts	DC resistance (m Ω)	Imax (A)	
			25°	125°
WBS1.5-5/4.8/10-3S4	60	< 7.5	5	4.2
WBS1.5-5/4.8/10-4BI	60	< 7.5	5	4.2
WBS2.5-5/4.8/10-3S4	60	< 9	5	4.2
WBS2.5-5/4.8/10-4BI	60	< 9	5	4.2

Table 17. SMD wide-band chokes electrical characteristics.

6.2.4 PACKAGING AND ORDERING CODES

The SMD wide-band chokes are delivered taped and reeled, ready for use in automatic mounting machines. The packaging is according to IEC 286-A and EIA 481-A

TYPE	PACKING QUANTITY [PCS / REEL]	ORDERING CODE [12 NC]
WBS1.5-5/4.8/10-4BI	1650	43300304177_
WBS1.5-5/4.8/10-3S4	1650	43300304176_
WBS1.5-5/10-3S4-Z	1650	43300306901_
WBS2.5-5/4.8/10-4BI	1650	43300304168_
WBS2.5-5/10-4BI-Z	1650	43300306900_
WBS2.5-5/4.8/10-3S4	1650	43300304166-
WBS2.5-5/10-3S4-Z	1650	43300304199_
WBSM2.5-5/4.8/10-4BI	1680	43300304195_

Table 18. SMD wide-band chokes packaging and ordering codes.

6.2.5 BLISTER TAPE AND REEL DIMENSIONS

SIZE	DIMENSIONS (mm)	
	WBS1.5-5/4.8/10	WBS2.5-5/4.8/10
A0	5.51	5.51
B0	11	11
K0	5.03	5.03
T	0.36	0.36
W	24	24
E	1.75	1.75
F	11.5	11.5
D0	1.5	1.5
D1	≥1.5	≥1.5
P0	4.0	4.0
PI	8.0	8.0
P2	2.0	2.0

Table 19. Physical dimensions of blister tape (in millimeters)*

*Note: Figure 5 for reference detailed dimensions.

SIZE	DIMENSIONS (mm)			
	A	N	W1	W2
24	330	100 ± 0.5	24.4	≤28.4

Table 20. Physical dimensions of reel (in millimeters)*

*Note: Figure 7 for reference detailed dimensions.

6.2.6 RECOMMENDED SOLDER LANDS

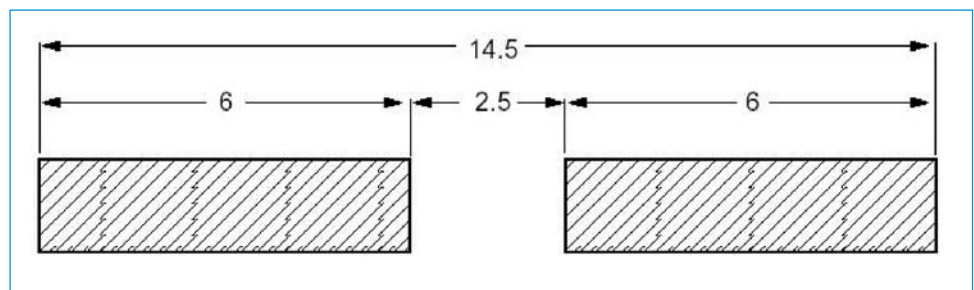
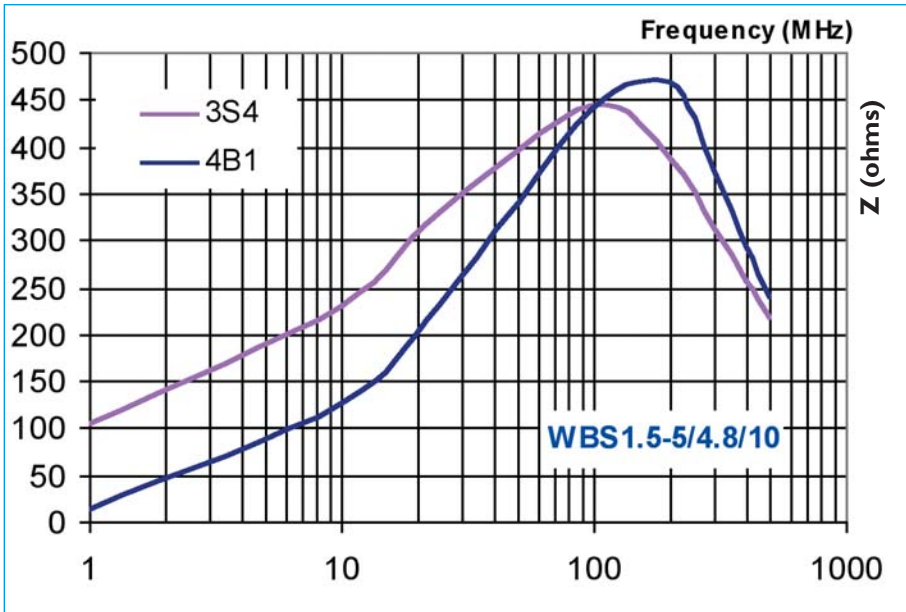

Figure 44. Recommended solder lands for SMD wide-band chokes WBS1.5-5/4.8/10 and WBS2.5-5/4.8/10



6.2.7 TYPICAL IMPEDANCE CURVES

Figure 45. Z graph WBS1.5-5/4.8/10-3S4 and WBS1.5-5/4.8/10-4B1

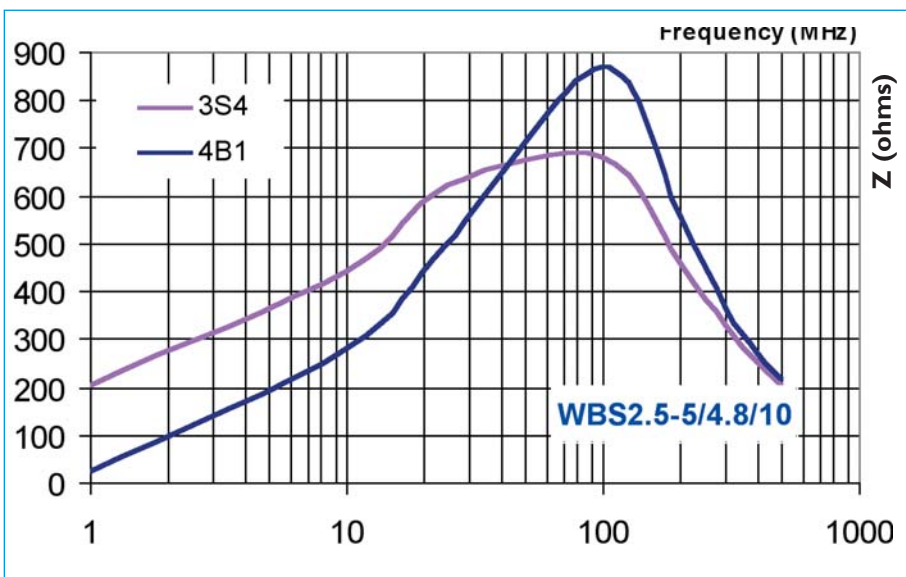

Figure 46 Z graph WBS2.5-5/4.8/10-3S4 and WBS2.5-5/4.8/10-4B1

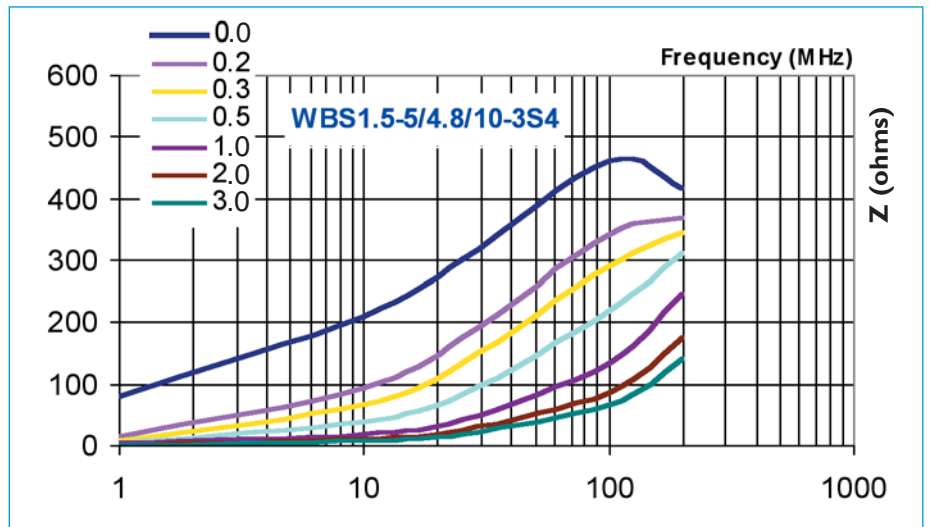

Figure 47. Impedance vs. frequency for WBS1.5-5/4.8/10-3S4 under DC-premagnetization

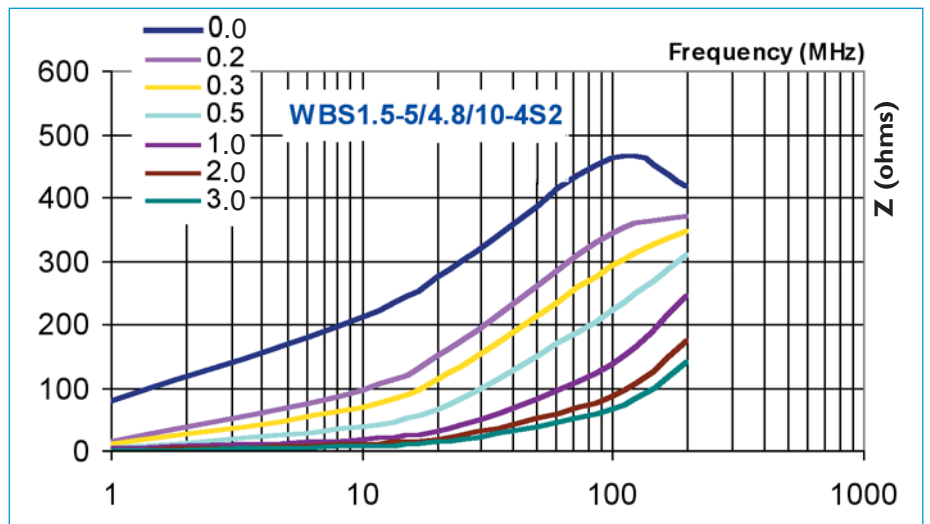

Figure 48. Impedance vs. frequency for WBS1.5-5/4.8/10-4S2 under DC-premagnetization

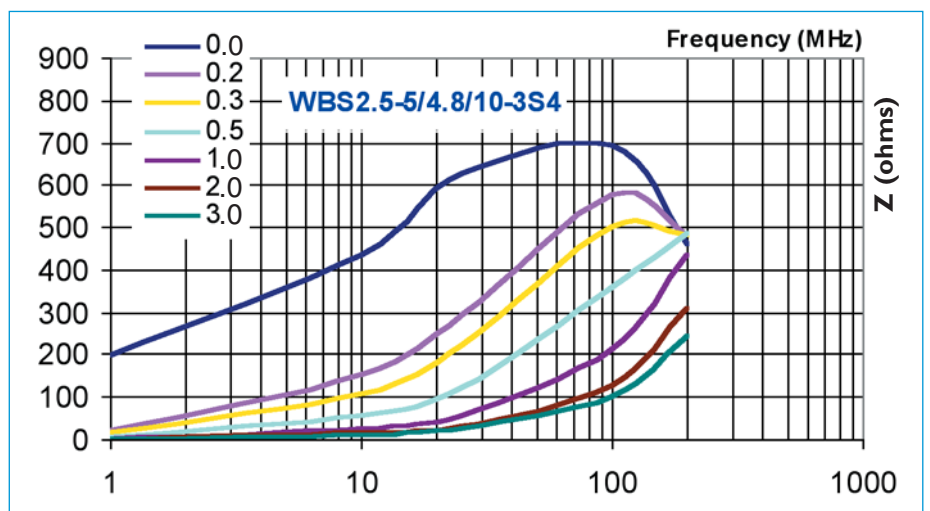

Figure 49. Impedance vs. frequency for WBS2.5-5/4.8/10-3S4 under DC-premagnetization

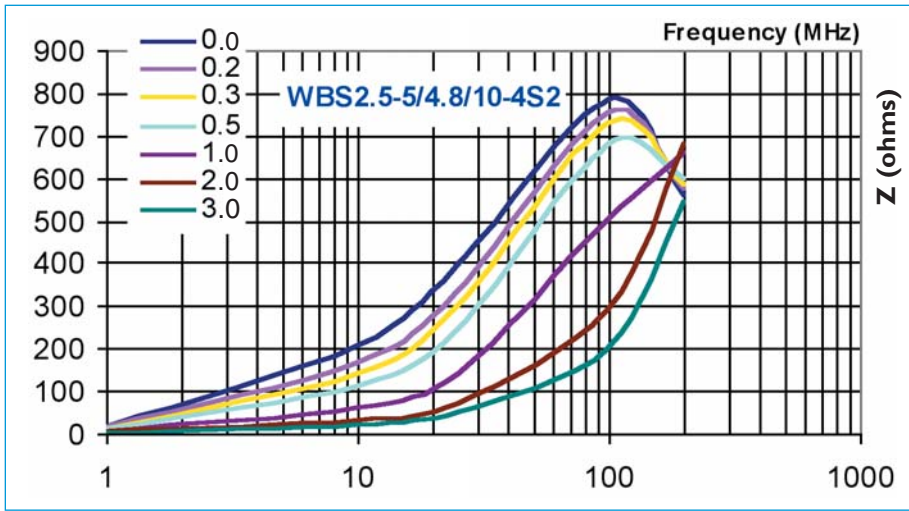
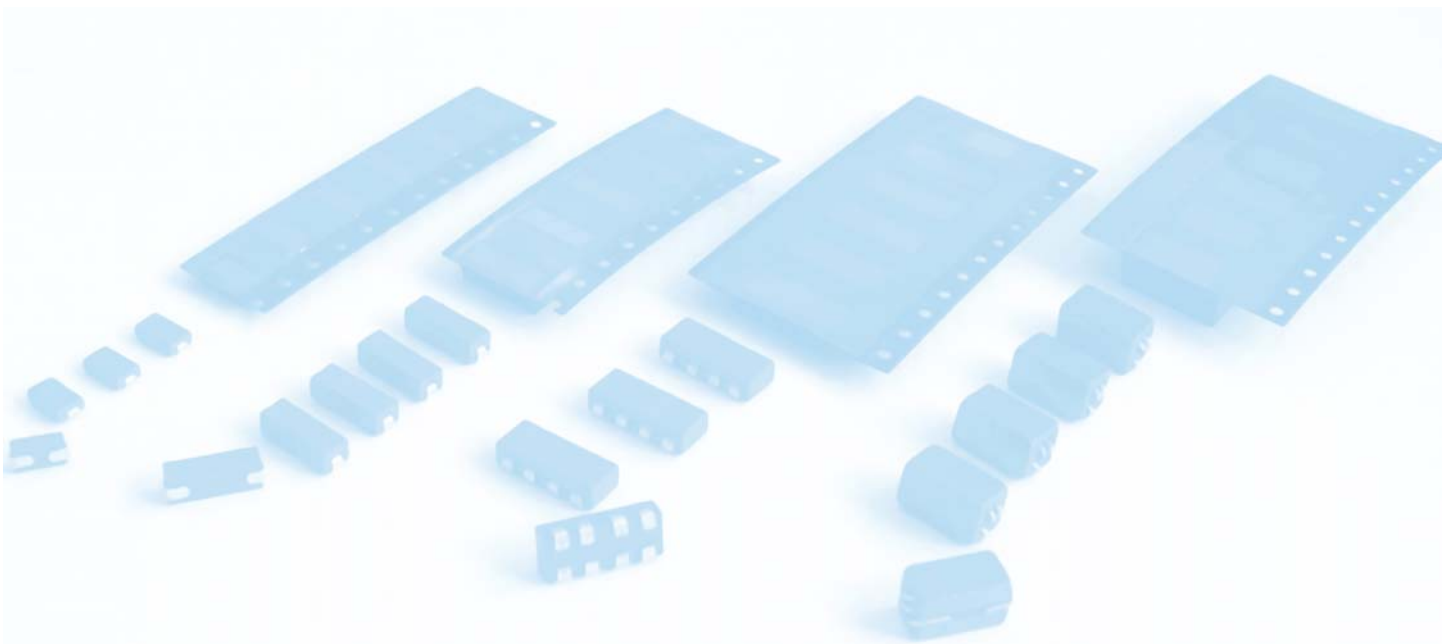

Figure 50. Impedance vs. frequency for WBS2.5-5/4.8/10-4S2 under DC-premagnetization



6.2.8 TYPICAL DAMPING CURVES

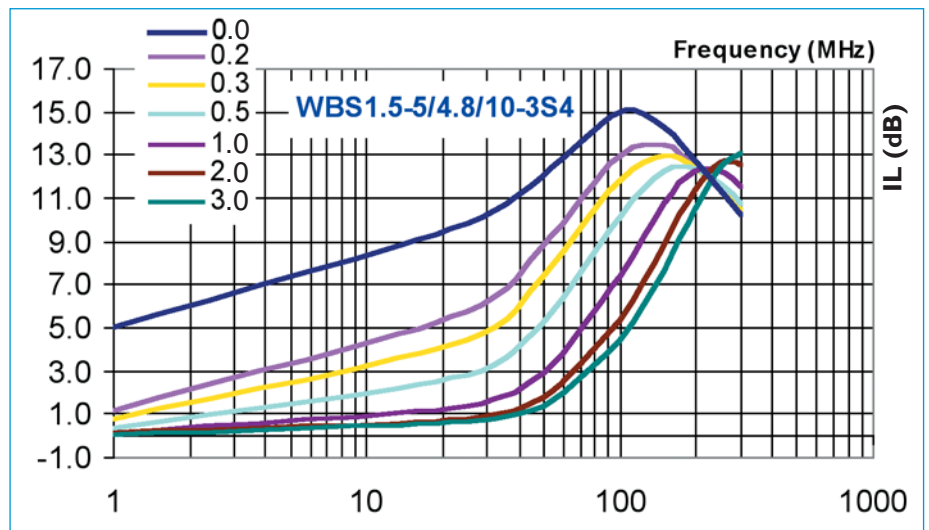

Figure 51. Attenuation vs. frequency for WBS1.5-5/4.8/10-3S4 under DC-premagnetization

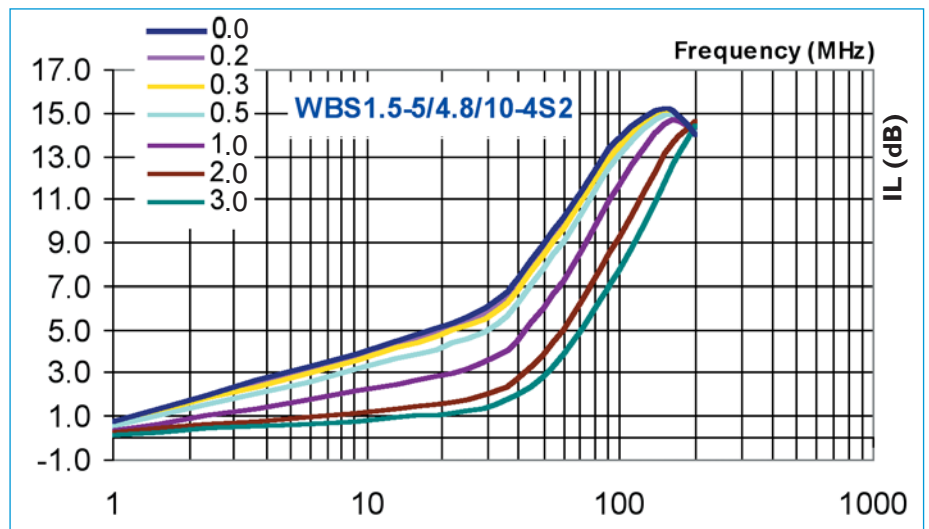

Figure 52. Attenuation vs. frequency for WBS1.5-5/4.8/10-4S2 under DC-premagnetization

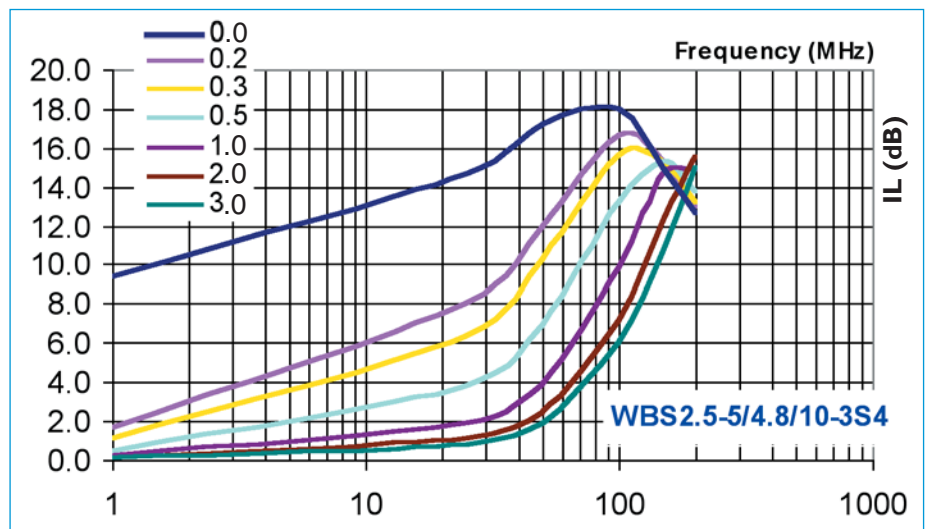

Figure 53. Attenuation vs. frequency for WBS2.5-5/4.8/10-3S4 under DC-premagnetization

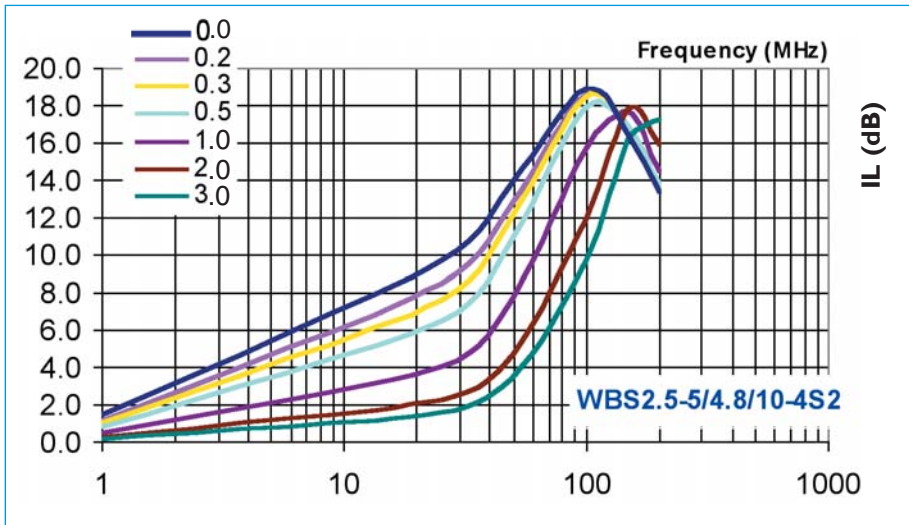
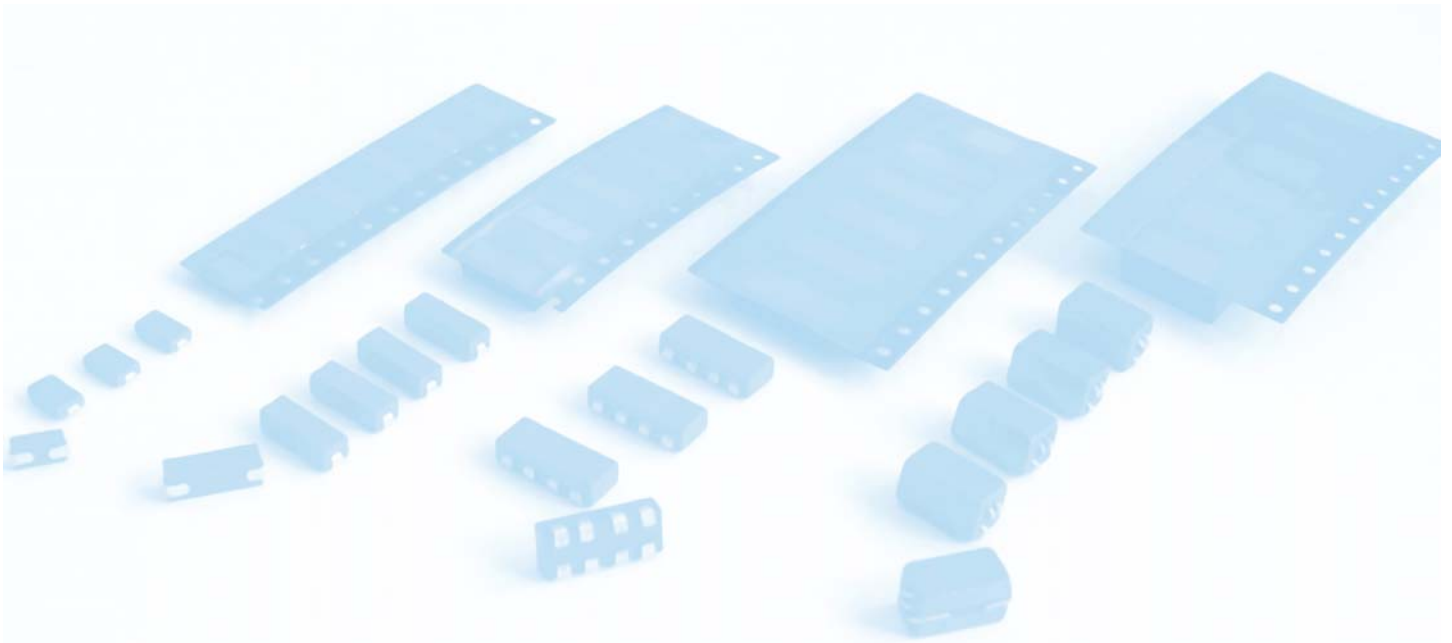

Figure 54. Attenuation vs. frequency for WBS2.5-5/4.8/10-4S2 under DC pre-magnetization



7.0 GAPPED SMD BEADS FOR POWER INDUCTORS

Traditional power supply architectures for PC's are facing problems with the latest generation of integrated circuits. Lower voltages and higher currents lead to increasing losses in supply lines and sensitivity to interference. On top of this, fast microprocessors introduce high frequency transients which are difficult to regulate with a voltage regulator module (VRM) from a distant main supply.

7.1 PRODUCT APPLICATION

The fundamental solution utilizes and intermediate voltage and distributed point of load (POL) converters. These are small dc/dc converters, placed close to the load on the PCB.

Ferroxcube now introduces gapped SMD beads, perfectly suitable for the POL concept. They are small inductors typically meant to serve as output inductor in buck / boost stage and feature the state of the art power material 3C96. Depending on relative ripple current, switching frequencies up to 1 MHz are possible to realize compact geometries. Saturation rated current goes up to 20 A and the dc resistance is less than 1 m Ω .

These gapped beads are available in 2 sizes (1812 and 3512), packed in tape on reel, and they are SMD mountable. Furthermore, they are lead-free and fully comply with the RoHS regulations on hazardous substances.



Figure 55. Gapped SMD beads

Our lowest loss general power material, 3C96 is an excellent choice to use in high-frequency output inductors. With a small ripple only, it can work at much higher switching frequency than it would as transformer material, preserving its highest higher saturation over real high-frequency transformer materials.

7.2 PRODUCT SPECIFICATION

7.2.1 GENERAL SPECIFICATION

FEATURES:

- Very suitable for POL converter concept
- High switching frequency, up to 1 MHz
- High current rating, up to 20 A
- Low dc resistance, less than 1 m Ω
- Small size (1812 and 3512)
- SMD mountable
- Lead-free / RoHS compliant

APPLICATIONS:

- Output inductor dc/dc converters
- EMI suppression with high current

TYPE DESCRIPTION:

e.g. BDS3/3/4.6-3C96-A75
(1)(2) (3) (4) (5) (6)

- (1) Product type (BDS = Bead for Surface mounting)
- (2) Width (in mm)
- (3) Height (in mm)
- (4) Length (in mm)
- (5) Material grade
- (6) AL inductor value

ORDERING CODE (12 NC):

e.g. 433003072431

The first 11 digits of the 12 NC are sufficient to order the desired SMD wide band choke. SMD wide band chokes are delivered taped and reeled, ready for use on automatic mounting machines.

7.2.2 SHAPE AND DIMENSIONS

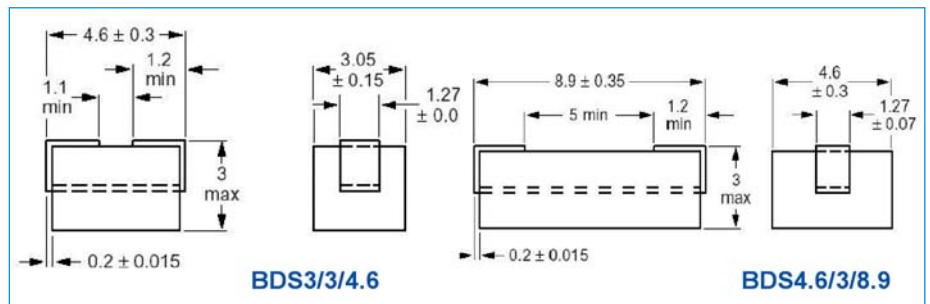

Figure 56. Gapped SMD chip beads dimensions (in millimeters)

7.2.3 ELECTRICAL CHARACTERISTICS

TYPE	AL	Mass
	nH / t ²	(g)
BDS3/3/4.6-3C96-A50	50 +- 20%	≈ 0.15
BDS3/3/4.6-3C96-A75	75 +- 20%	≈ 0.15
BDS4.6/3/8.9-A100	100 +- 20%	≈ 0.15
BDS4.6/3/8.9-A150	150 +- 20%	≈ 0.15

Table 21. Gapped SMD beads electrical characteristics

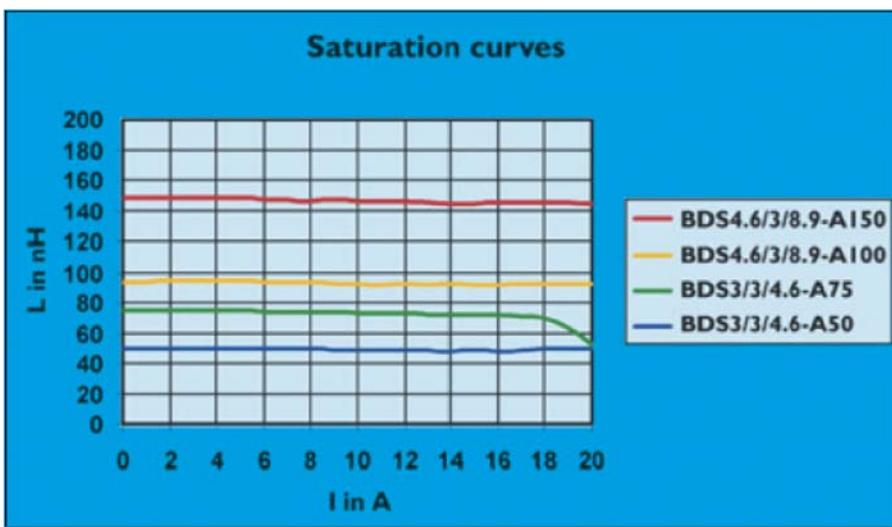

Figure 57. Saturation Curves gapped SMD beads

TYPE	Maximum Vdc	DC resistance (mΩ)	Isat* (mA)	Imax (A)	
	Volts			25°	125°
BDS3/3/4.6-3C96-A50	60	< 0.6	20	20	17
BDS3/3/4.6-3C96-A75	60	< 0.6	15	20	17
BDS4.6/3/8.9-A100	60	< 1.0	20	20	17
BDS4.6/3/8.9-A150	60	< 1.0	20	20	17

Table 22. Chip bead electrical characteristics*

*Note: Isat is defined as the saturation rated current

7.2.4 PACKAGING AND ORDERING CODES

The Capped SMD beads are delivered taped and reeled, ready for use in automatic mounting machines. The packaging is according to IEC 286-A and EIA 481-A

TYPE	PACKING QUANTITY [PCS / REEL]	ORDERING CODE [12 NC]
BDS3/3/4.6-3C96-A50	3000	43300307234_
BDS3/3/4.6-3C96-A75	3000	43300307235_
BDS4.6/3/8.9-A100	2400	43300307243_
BDS4.6/3/8.9-A150	2400	43300307244_

Table 23. Gapped SMD beads packaging quantities and ordering code

7.2.5 BLISTER TAPE AND REEL DIMENSIONS

SIZE	DIMENSIONS (mm)	
	BDS3/3/4.6	BDS4.6/3/8.9
A0	3.45 ± 0.1	3.25 ± 0.1
B0	5.1 ± 0.1	9.4 ± 0.1
K0	3.1 ± 0.1	3.1 ± 0.1
T	0.25 ± 0.05	0.3 ± 0.05
W	12.0 ± 0.3	16.0 ± 0.3
E	1.75 ± 0.1	1.75 ± 0.1
F	5.5 ± 0.05	7.5 ± 0.05
D0	1.5 + 0.1	1.5 + 0.1
D1	> 1.5	> 1.5
P0	4.0 ± 0.1	4.0 ± 0.1
P1	8.0 ± 0.1	8.0 ± 0.1
P2	2.0 ± 0.05	2.0 ± 0.1

Table 24. Physical dimensions of blister tape (in millimeters)

*Note: Figure 5 for reference detailed dimensions.

SIZE	DIMENSIONS (mm)			
	A	N	W ₁	W ₂
12	3.30	100 ± 0.5	12.4	≤ 16.4
16	2.30	100 ± 0.5	16.4	≤ 20.4

Table 24. Physical dimensions of reel (in millimeters)

*Note: Figure 7 for reference detailed dimensions.

7.2.6 RECOMMENDED SOLDER LANDS

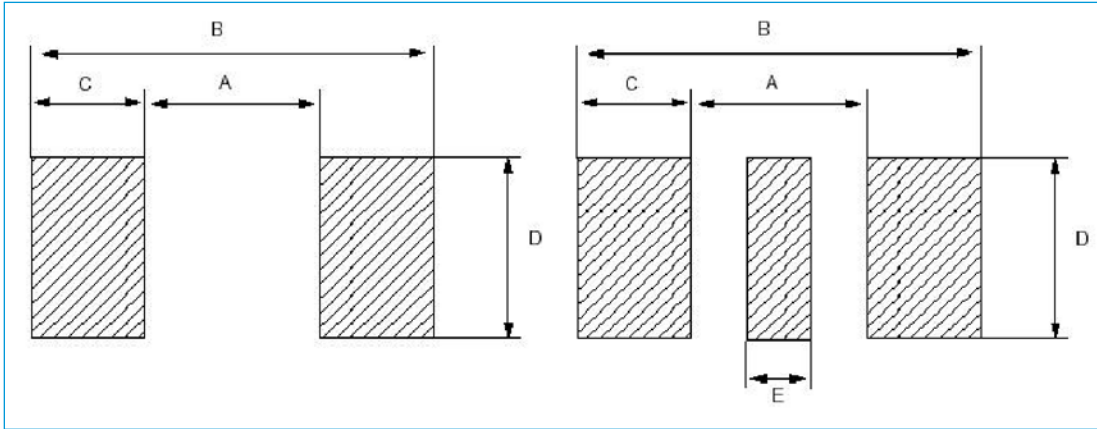
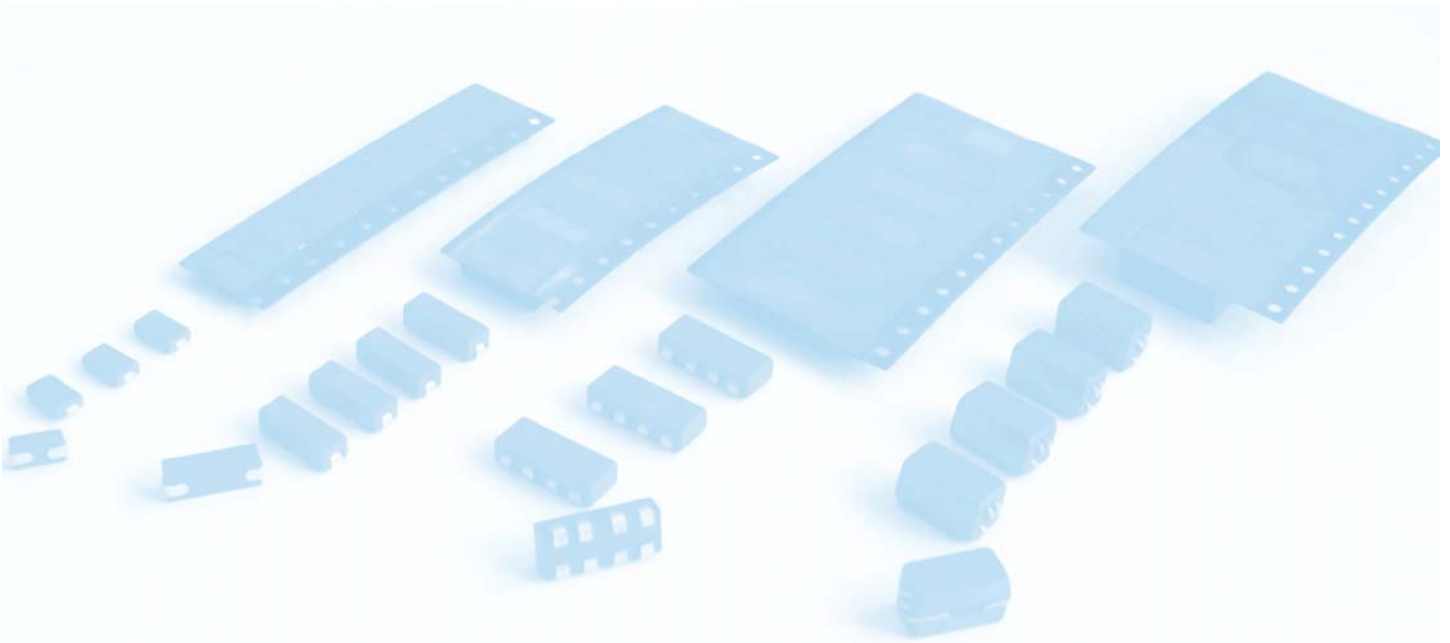

Figure 58a. Solder lands reflow soldering

Figure 58b. Solder lands wave soldering

SHAPE	Reflow soldering				Wave soldering				
	A	B	C	D	A	B	C	D	E
BDS3/3/4.6	2.8	6.4	1.8	3.3	2.0	6.4	2.2	3.0	0.8
BDS4.6/3/8.9	7.0	10.8	1.9	3.3	6.0	12.2	3.1	3.0	2.5

Table 26. Dimensions (mm) of solder lands



8.0 SOLDERING CURVES

Our surface mountable beads, common mode and wide-band chokes can be placed and soldered onto any normal printed circuit board or hybrid circuits.

Suitable methods include those where the device is immersed in solder, wave soldering, reflow methods where the solder and device are heated together, and in vapor phase soldering.

The robust construction of these SMD components enables them to be totally immersed in a solder bath at 255° up to 10 seconds for lead parts and up to 30 seconds at 260° for lead-free products without damage. This facilitates the mounting of leaded discrete components on the components side of a board after surface mountable beads or chokes have been attached to the side to be soldered, thus making a 'mixed print' board.

Typical temperature / time curves for different soldering methods are shown in next figures 59, 60, 61 for leaded products and 62 for lead-free parts. They show a preheating stage, followed by the soldering process at which the SMD components are fully subjected to the soldering temperature, and then finally cooling. Beads, common mode and wide-band chokes are able to withstand both the rapid rise in temperature, prior to soldering and the high temperature of the soldering process

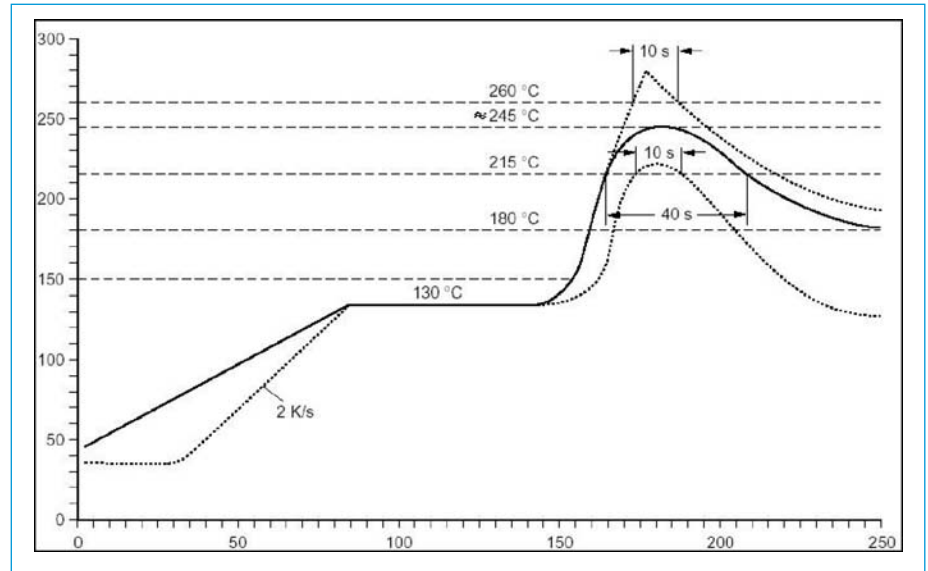

Figure 59. Reflow soldering curve

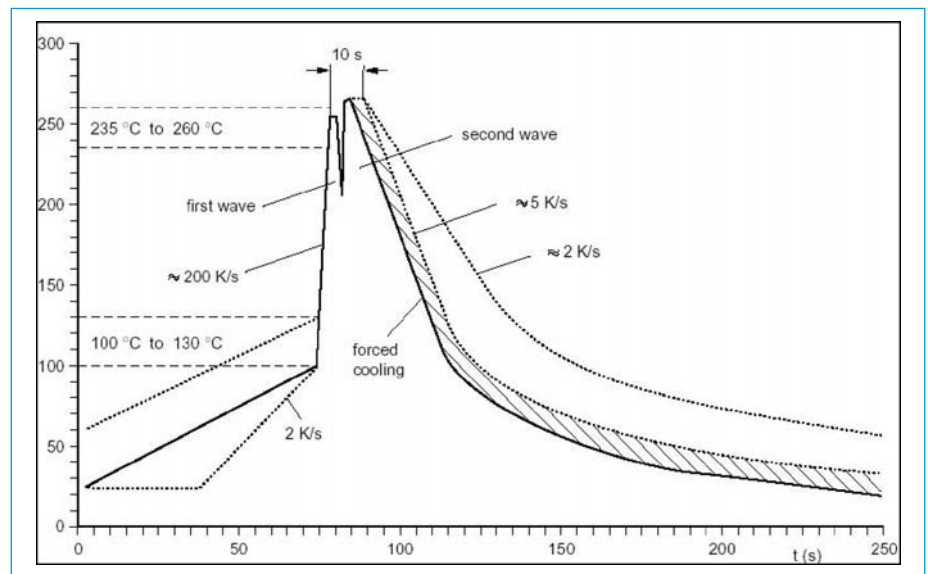

Figure 60. Wave soldering

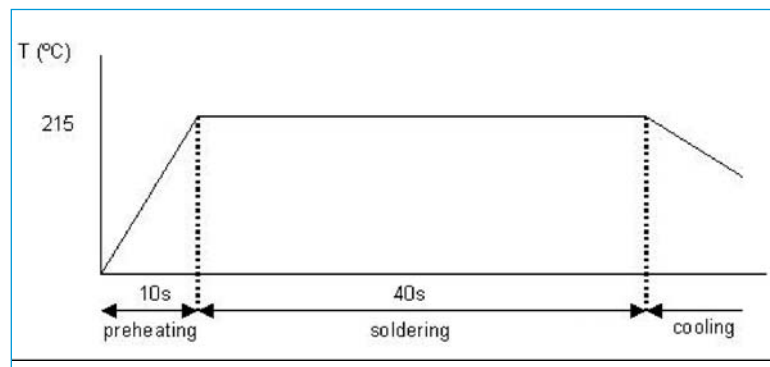

Figure 61. Vapor phase soldering

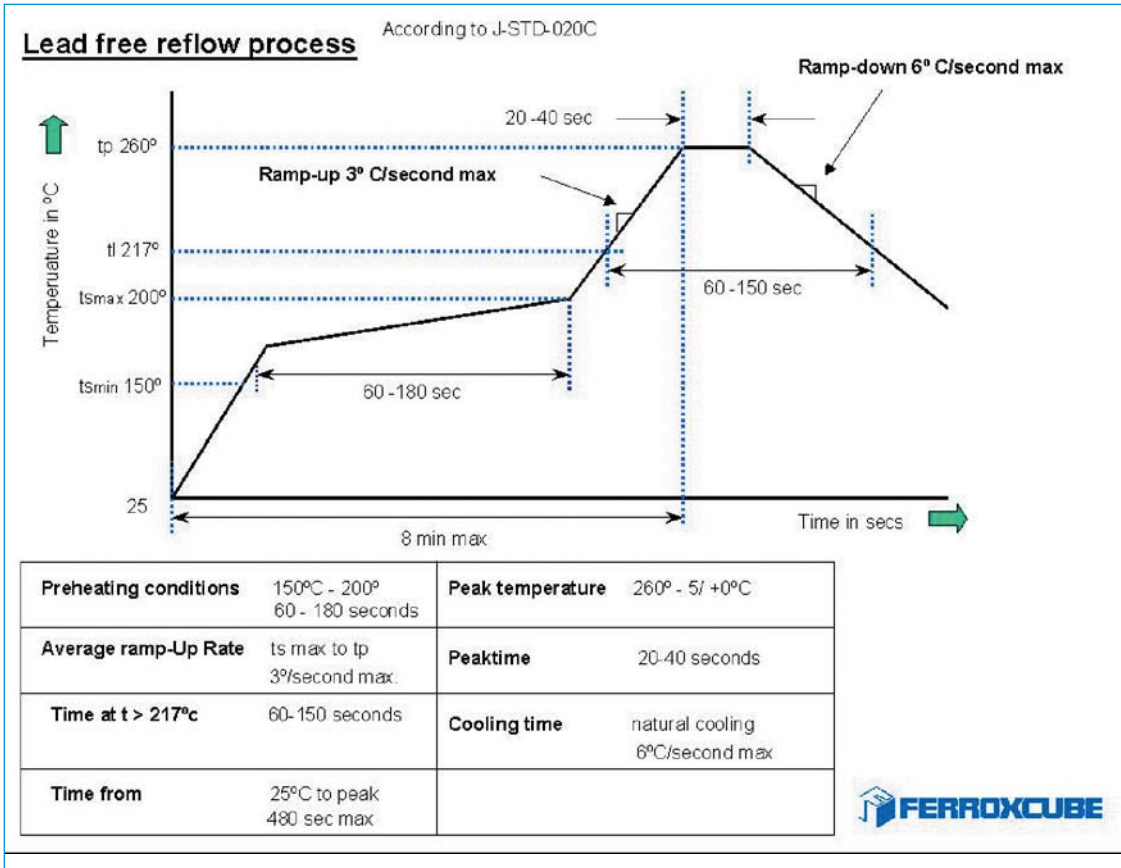

Figure 62. Reflow soldering profile for lead-free types according to JEDEC STD.

9.0 MAXIMUM CURRENT LIMITS IN FUNCTION OF TEMPERATURE

Next graphs shows maximum current that could be applied to Ferroxcube SMD parts and Rdc correspondat temperature variability:

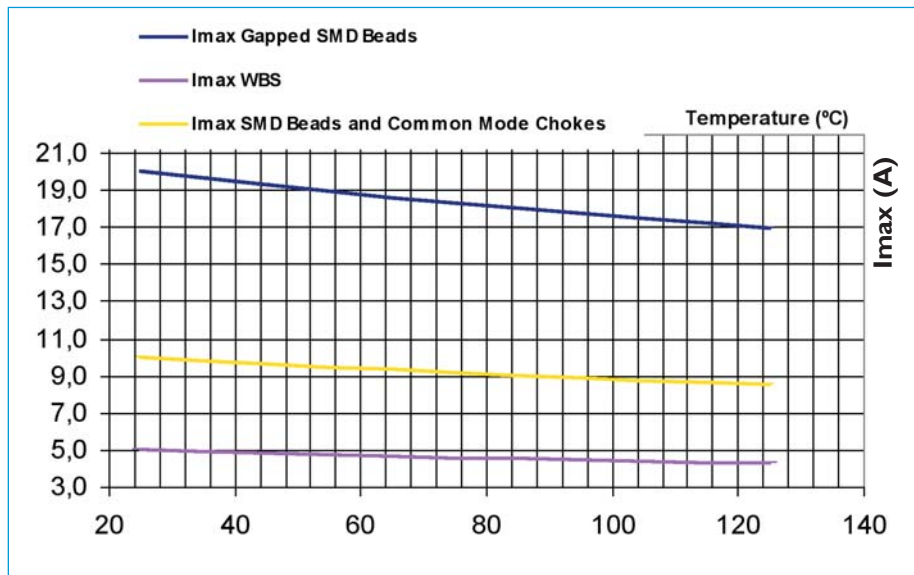

Figure 63. Imax. in function of temperature for SMD beads, common mode and wide band chokes.

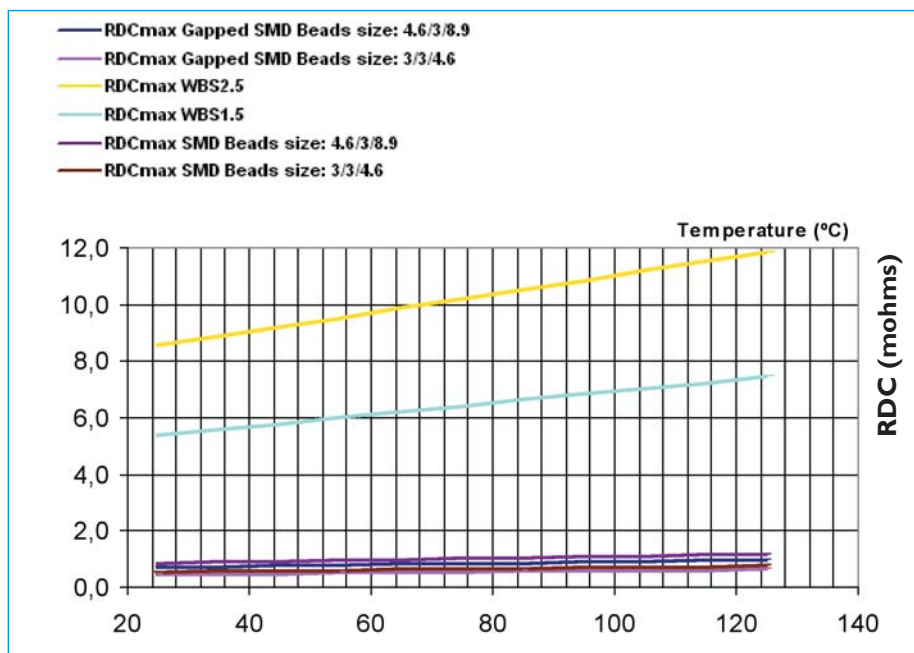

Figure 64. RDC in function of temperature for SMD beads, common mode and wide band chokes