

Wire to Board Connectors

Connector System for Universal Serial Bus (USB)

Receptacle Assemblies/Series A, 4-Position, Right-Angle

**Panel Mount
with Flame
SMT Type, Standard**

Part Number : 353929-1
(Emboss Tape Mounted, ea. 350)

(Tape Width : 44mm)

Part Number : 353583-1
(Tray Packer, ea. 55)

Material and Finish :

Housing—Thermoplastic, UL 94V-0, rated, white

Shell—Copper Alloy, plated bright tin

Contacts—Copper Alloy, plated gold over palladium-nickel on the mating end, tin lead on the section, all over nickel underplating.

Product Specifications :

108-5563

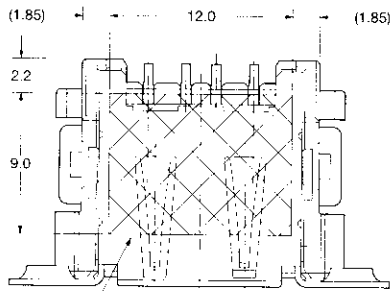

Tape (#353929-1 only)

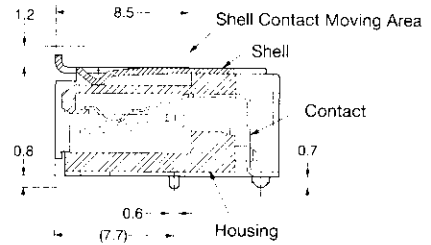
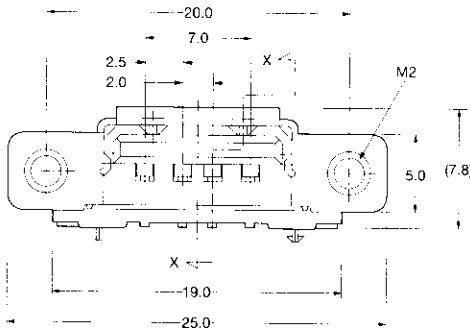

Section X-X

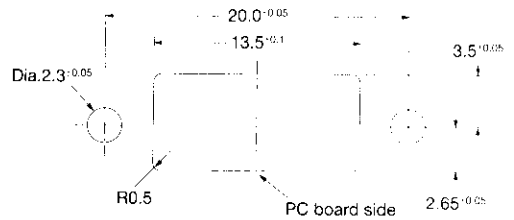
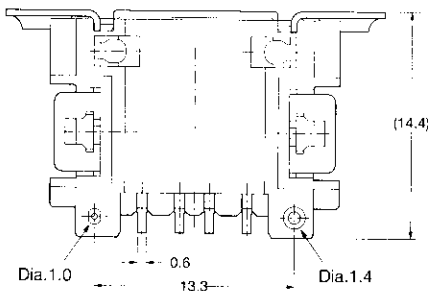
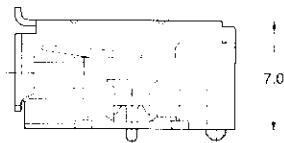

Panel Cutout

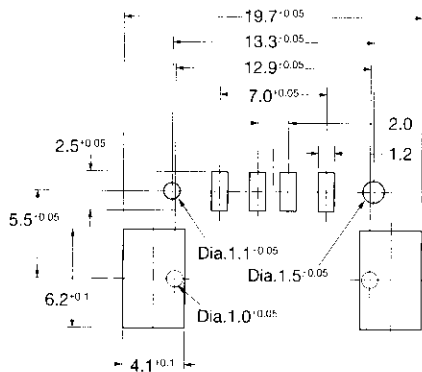

PC Board Layout (Component Side)

4