

Metallized Polyester Film Capacitors

MKT Radial Epoxy Lacquered Type

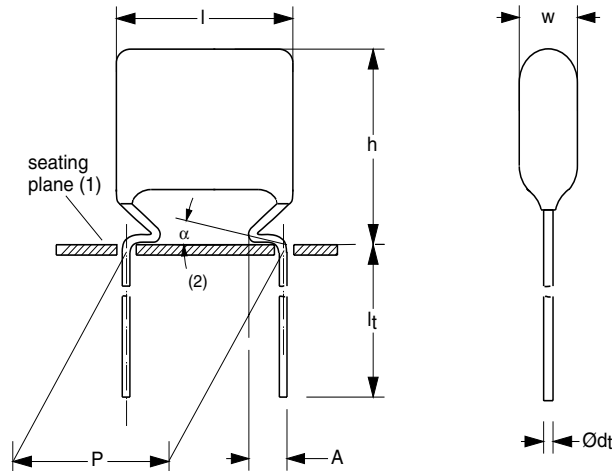

Dimensions in mm

- (1) Hole \varnothing 1.0 for $d_t = 0.6$ mm
Hole \varnothing 1.3 for $d_t = 0.8$ mm
- (2) $0 \leq \alpha < 50^\circ$
- (3) $A = 2.0 + 1.0/-0.5$ mm (pitch = 10.0 mm)
 $A = 2.5 + 1.4/-0.5$ mm (pitch = 15.0 mm, 22.5 mm and 27.5 mm)

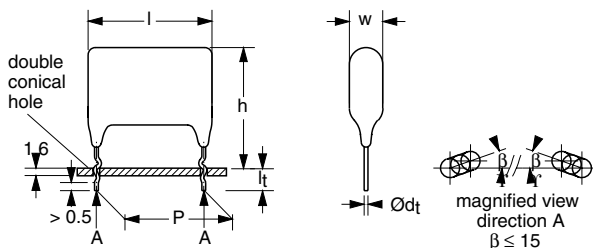

Dimensions in mm

APPLICATIONS

Blocking and coupling. Bypass and energy reservoir

MARKING

C-value; tolerance; rated voltage

DIELECTRIC

Polyester film

ELECTRODES

Vacuum deposited aluminium

FEATURES

- Available taped on reel and loose in box
- Lead (Pb)-free product
- RoHS-compliant product



RoHS
COMPLIANT

COATING

Flame retardant epoxy material (UL-class 94 V-0)

CONSTRUCTION

Wound mono construction

LEADS

Tinned wire

CAPACITANCE RANGE (E12 SERIES)

0.001 to 1.0 μ F

CAPACITANCE TOLERANCE

$\pm 10\%$; $\pm 5\%$

RATED (DC) VOLTAGE

63 V; 100 V; 250 V; 400 V; 630 V

RATED (AC) VOLTAGE

40 V; 63 V; 160 V; 220 V; 250 V

CLIMATIC CATEGORY

55/105/56

RATED TEMPERATURE

85 °C

MAXIMUM APPLICATION TEMPERATURE

105 °C

REFERENCE SPECIFICATIONS

IEC 60384-2

PERFORMANCE GRADE

Grade 1 (long life)

DETAIL SPECIFICATION

For more detailed data and test requirements see "Type detail specification HQN-384-02/101"



COMPOSITION OF CATALOG NUMBER

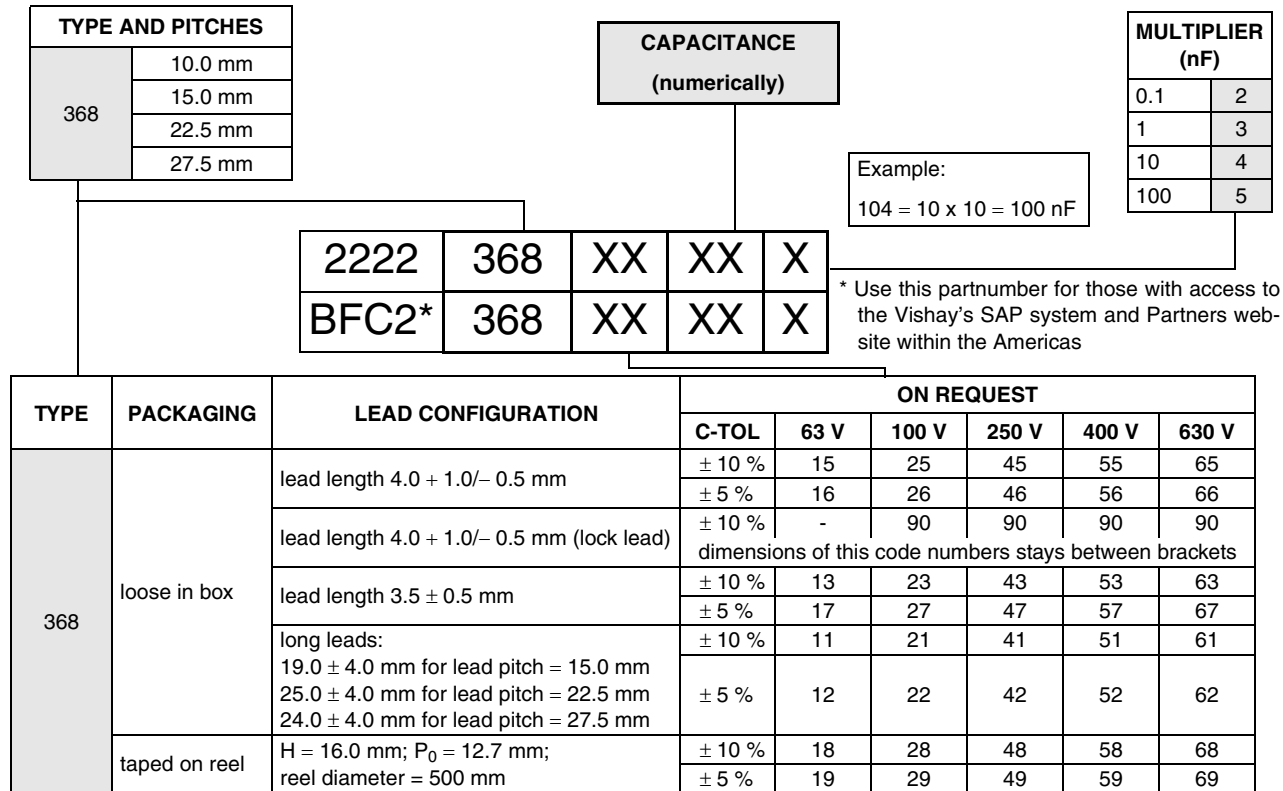

SPECIFIC REFERENCE DATA

| DESCRIPTION | VALUE | | | | |
|---|-------------------------|-----------------|--------------------------|--------------------------|------------------|
| | at 1 kHz | | at 10 kHz | at 100 kHz | |
| Tangent of loss angle: | | | | | |
| C ≤ 0.1 μF | ≤ 75 × 10 ⁻⁴ | | ≤ 130 × 10 ⁻⁴ | ≤ 225 × 10 ⁻⁴ | |
| 0.1 μF < C ≤ 0.47 μF | ≤ 75 × 10 ⁻⁴ | | ≤ 130 × 10 ⁻⁴ | ≤ 300 × 10 ⁻⁴ | |
| 0.47 μF < C ≤ 1.0 μF | ≤ 75 × 10 ⁻⁴ | | ≤ 130 × 10 ⁻⁴ | - | |
| Rated voltage pulse slope (dU/dt) _R | at 63 V (DC) | at 100 V (DC) | at 250 V (DC) | at 400 V (DC) | at 630 V (DC) |
| P = 10 mm | 30 V/μs | 30 V/μs | 70 V/μs | 110 V/μs | 70 V/μs |
| P = 15 mm | | 20 V/μs | 28 V/μs | 44 V/μs | 70 V/μs |
| P = 22.5 mm | | 8 V/μs | 12 V/μs | 20 V/μs | 28 V/μs |
| P = 27.5 mm | | 7 V/μs | 10 V/μs | 16 V/μs | 24 V/μs |
| R between leads, for C ≤ 0.33 μF: | | | | | |
| at 10 V; 1 minute | > 15000 MΩ | | | | |
| at 100 V; 1 minute | | > 15000 MΩ | > 30000 MΩ | > 30000 MΩ | |
| at 500 V; 1 minute | | | | | > 30000 MΩ |
| RC between leads, for C > 0.33 μF: | | | | | |
| at 10 V; 1 minute | > 5000 s | | | | |
| at 100 V; 1 minute | | > 5000 s | > 10000 s | > 10000 s | |
| at 500 V; 1 minute | | | | | > 10000 s |
| R between interconnecting leads and casing; | | | | | |
| at 10 V; 1 minute | > 30000 MΩ | | | | |
| at 100 V; 1 minute | | > 30000 MΩ | > 30000 MΩ | > 30000 MΩ | |
| at 500 V; 1 minute | | | | | > 30000 MΩ |
| Withstanding (DC) voltage (cut off current 10 mA); rise time 100 V/s | 100 V; 1 minute | 160 V; 1 minute | 400 V; 1 minute | 640 V; 1 minute | 1008 V; 1 minute |
| Withstanding (DC) voltage between leads and case | 200 V; 1 minute | 200 V; 1 minute | 500 V; 1 minute | 800 V; 1 minute | 1260 V; 1 minute |



Metallized Polyester Film Capacitors Vishay BCcomponents
MKT Radial Epoxy Lacquered Type

U_{Rdc} = 63 V; U_{Rac} = 40 V

| C (μ F) | DIMENSIONS $w_{max} \times h_{max} \times l_{max}$ (mm) | MASS (g) | CATALOG NUMBER 2222 368 AND PACKAGING | | | | | |
|---|---|-------------|---|------------------------------------|------------|------|-------------------------------|------|
| | | | LOOSE IN BOX | | | REEL | LOOSE IN BOX | |
| | | | $l_t =$ 4.0 + 1.0/- 0.5 mm | short leads | long leads | SPQ | $l_t =$ 4.0 + 1.0/- 0.5 mm | SPQ |
| | | | C-tol = \pm 10 % | | | | C-tol = \pm 10 % | |
| last 5 digits of catalog number | SPQ | SPQ | SPQ | last 5 digits of catalog number | SPQ | | | |
| Pitch = 10.0 \pm 0.4 mm; d_t = 0.60 \pm 0.06 mm | | | | | | | lock lead | |
| 0.22 | 4.2 \times 13.2 (15.5) \times 12.5 | 0.5 | 15224 | 2000 | 1000 | 1300 | 90316 | 1100 |
| 0.27 | 4.0 \times 12.8 (15.5) \times 12.5 | 0.5 | 15274 | 2000 | 1000 | 1300 | 90317 | 1100 |
| 0.33 | 4.3 \times 13.1 (15.5) \times 12.5 | 0.5 | 15334 | 2000 | 1000 | 1300 | 90318 | 1100 |
| 0.39 | 4.2 \times 12.9 (15.5) \times 12.5 | 0.5 | 15394 | 2000 | 1000 | 1300 | 90319 | 1100 |
| 0.47 | 4.3 \times 13.4 (16.0) \times 12.5 | 0.5 | 15474 | 2000 | 1000 | 1200 | 90321 | 1000 |
| 0.56 | 4.7 \times 13.7 (16.0) \times 12.5 | 0.5 | 15564 | 2000 | 1000 | 1200 | 90322 | 1000 |
| 0.68 | 5.1 \times 14.1 (16.5) \times 12.5 | 0.6 | 15684 | 2000 | 1000 | 1100 | 90323 | 1500 |
| 0.82 | 5.5 \times 14.5 (17.0) \times 12.5 | 0.6 | 15824 | 2000 | 1000 | 1000 | 90324 | 1250 |
| 1 | 6.0 \times 15.0 (17.5) \times 12.5 | 0.8 | 15105 | 2000 | 1000 | 900 | 90325 | 1250 |

U_{Rdc} = 100 V; U_{Rac} = 63 V

| C (μ F) | DIMENSIONS $w_{max} \times h_{max} \times l_{max}$ (mm) | MASS (g) | CATALOG NUMBER 2222 368 AND PACKAGING | | | | | |
|---|---|-------------|---|------------------------------------|------------|------|-------------------------------|------|
| | | | LOOSE IN BOX | | | REEL | LOOSE IN BOX | |
| | | | $l_t =$ 4.0 + 1.0/- 0.5 mm | short leads | long leads | SPQ | $l_t =$ 4.0 + 1.0/- 0.5 mm | SPQ |
| | | | C-tol = \pm 10 % | | | | C-tol = \pm 10 % | |
| last 5 digits of catalog number | SPQ | SPQ | SPQ | last 5 digits of catalog number | SPQ | | | |
| Pitch = 10.0 \pm 0.4 mm; d_t = 0.60 \pm 0.06 mm | | | | | | | lock lead | |
| 0.056 | 4.0 \times 13.0 (15.0) \times 12.5 | 0.4 | 25563 | 2000 | 1000 | 1500 | 90205 | 1250 |
| 0.068 | | | 25683 | | | | 90206 | |
| 0.082 | 3.7 \times 12.7 (15.0) \times 12.5 | 0.4 | 25823 | 2000 | 1000 | 1500 | 90207 | 1250 |
| 0.1 | 4.0 \times 13.0 (15.0) \times 12.5 | 0.4 | 25104 | 2000 | 1000 | 1500 | 90208 | 1250 |
| 0.12 | 4.3 \times 13.3 (15.0) \times 12.5 | 0.4 | 25124 | 2000 | 1000 | 1500 | 90209 | 1250 |
| 0.15 | 3.9 \times 12.9 (15.0) \times 12.5 | 0.4 | 25154 | 2000 | 1000 | 1500 | 90211 | 1250 |
| 0.18 | 4.2 \times 13.2 (15.5) \times 12.5 | 0.5 | 25184 | 2000 | 1000 | 1300 | 90212 | 1100 |
| 0.22 | 4.5 \times 13.6 (16.0) \times 12.5 | 0.5 | 25224 | 2000 | 1000 | 1200 | 90213 | 1000 |
| Pitch = 15.0 \pm 0.4 mm; d_t = 0.80 \pm 0.08 mm | | | | | | | lock lead | |
| 0.27 | 5.0 \times 14.0 (17.0) \times 17.5 | 0.6 | 25274 | 2000 | 1000 | 1200 | 90214 | 1750 |
| 0.33 | | | 25334 | | | | 90215 | |
| 0.39 | | | 25394 | | | | 90216 | |
| 0.47 | 5.5 \times 14.5 (17.5) \times 17.5 | 0.7 | 25474 | 2000 | 1000 | 1100 | 90217 | 1500 |
| 0.56 | | | 25564 | | | | 90218 | |
| 0.68 | 6.0 \times 15.0 (18.0) \times 17.5 | 0.9 | 25684 | 2000 | 1000 | 1000 | 90219 | 1500 |
| 0.82 | 6.5 \times 15.5 (18.5) \times 17.5 | 1.0 | 25824 | 1000 | 1000 | 900 | 90221 | 1250 |
| 1 | 7.5 \times 16.5 (19.5) \times 17.5 | 1.3 | 25105 | 1000 | 1000 | 800 | 90222 | 1000 |



| C (μ F) | DIMENSIONS $w_{max} \times h_{max} \times l_{max}$ (mm) | MASS (g) | CATALOG NUMBER 2222 368 AND PACKAGING | | | | | |
|--|---|-------------|---|------------------------------------|------------|------|-------------------------------|------|
| | | | LOOSE IN BOX | | | REEL | LOOSE IN BOX | |
| | | | $l_t =$ 4.0 + 1.0/- 0.5 mm | short leads | long leads | SPQ | $l_t =$ 4.0 + 1.0/- 0.5 mm | SPQ |
| | | | C-tol = \pm 10 % | | | | C-tol = \pm 10 % | |
| last 5 digits of catalog number | SPQ | SPQ | SPQ | last 5 digits of catalog number | SPQ | | | |
| Pitch = 22.5 \pm 0.4 mm; $d_t = 0.80 \pm 0.08$ mm | | | | | | | lock lead | |
| 1.2 | 6.0 \times 18.0 (21.0) \times 26.0 | 2.5 | 25125 | 1000 | 1000 | 650 | 90223 | 1000 |
| 1.5 | | | 25155 | | | | 90224 | |
| 1.8 | 7.0 \times 19.0 (22.0) \times 26.0 | 3.2 | 25185 | 1000 | 1000 | 650 | 90225 | 900 |
| 2.2 | 7.5 \times 19.5 (23.0) \times 26.0 | 3.5 | 25225 | 1000 | 500 | 600 | 90226 | 750 |
| 2.7 | 8.5 \times 21.5 (24.0) \times 26.0 | 4.1 | 25275 | 1000 | 500 | 500 | 90227 | 600 |
| 3.3 | 9.0 \times 22.0 (24.5) \times 26.0 | 4.5 | 25335 | 1000 | 500 | 450 | 90228 | 600 |
| Pitch = 27.5 \pm 0.4 mm; $d_t = 0.80 \pm 0.08$ mm | | | | | | | lock lead | |
| 3.9 | 9.0 \times 22.0 (24.0) \times 30.0 | 4.8 | 25395 | 500 | 500 | | 90229 | 500 |
| 4.7 | 10.0 \times 23.0 (25.0) \times 30.0 | 5.5 | 25475 | 500 | 500 | | 90178 | 400 |
| 5.6 | 11.0 \times 24.0 (26.0) \times 30.0 | 6.2 | 25565 | 500 | 250 | | 90231 | 350 |
| 6.8 | 12.0 \times 25.0 (27.0) \times 30.0 | 6.8 | 25685 | 500 | 250 | | 90232 | 350 |

$U_{Rdc} = 250$ V; $U_{Rac} = 160$ V

| C (μ F) | DIMENSIONS $w_{max} \times h_{max} \times l_{max}$ (mm) | MASS (g) | CATALOG NUMBER 2222 368 AND PACKAGING | | | | | |
|--|---|-------------|---|------------------------------------|------------|------|-------------------------------|------|
| | | | LOOSE IN BOX | | | REEL | LOOSE IN BOX | |
| | | | $l_t =$ 4.0 + 1.0/- 0.5 mm | short leads | long leads | SPQ | $l_t =$ 4.0 + 1.0/- 0.5 mm | SPQ |
| | | | C-tol = \pm 10 % | | | | C-tol = \pm 10 % | |
| last 5 digits of catalog number | SPQ | SPQ | SPQ | last 5 digits of catalog number | SPQ | | | |
| Pitch = 10.0 \pm 0.4 mm; $d_t = 0.60 \pm 0.06$ mm | | | | | | | lock lead | |
| 0.027 | 4.2 \times 13.0 (15.0) \times 12.5 | 0.4 | 45273 | 2000 | 1000 | 1500 | 90233 | 1250 |
| 0.033 | | | 45333 | | | | 90234 | |
| 0.039 | 4.0 \times 13.0 (15.0) \times 12.5 | 0.4 | 45393 | 2000 | 1000 | 1500 | 90235 | 1250 |
| 0.047 | 4.5 \times 13.5 (15.5) \times 12.5 | 0.5 | 45473 | 2000 | 1000 | 1500 | 90176 | 1250 |
| 0.056 | 4.6 \times 13.5 (15.5) \times 12.5 | 0.5 | 45563 | 2000 | 1000 | 1300 | 90236 | 1100 |
| 0.068 | | | 45683 | | | | 90237 | |
| 0.082 | 4.4 \times 13.4 (16.0) \times 12.5 | 0.5 | 45823 | 2000 | 1000 | 1200 | 90238 | 1000 |
| 0.1 | 4.7 \times 13.7 (16.0) \times 12.5 | 0.5 | 45104 | 2000 | 1000 | 1200 | 90177 | 1000 |
| Pitch = 15.0 \pm 0.4 mm; $d_t = 0.80 \pm 0.08$ mm | | | | | | | lock lead | |
| 0.12 | 5.0 \times 14.0 (17.0) \times 17.5 | 0.6 | 45124 | 2000 | 1000 | 1200 | 90239 | 1750 |
| 0.15 | | | 45154 | | | | 90241 | |
| 0.18 | 5.5 \times 14.5 (17.5) \times 17.5 | 0.7 | 45184 | 2000 | 1000 | 1100 | 90242 | 1500 |
| 0.22 | 6.0 \times 15.0 (18.0) \times 17.5 | 0.9 | 45224 | 2000 | 1000 | 1000 | 90243 | 1500 |
| 0.27 | 6.0 \times 15.5 (18.5) \times 17.5 | 1.0 | 45274 | 2000 | 1000 | 900 | 90244 | 1250 |
| 0.33 | 6.8 \times 16.0 (19.0) \times 17.5 | 1.2 | 45334 | 1000 | 1000 | 800 | 90245 | 1250 |
| Pitch = 22.5 \pm 0.4 mm; $d_t = 0.80 \pm 0.08$ mm | | | | | | | lock lead | |
| 0.39 | 5.0 \times 17.0 (20.0) \times 26.0 | 1.8 | 45394 | 1000 | 1000 | 800 | 90246 | 1250 |
| 0.47 | 5.5 \times 17.5 (20.5) \times 26.0 | 2.2 | 45474 | 1000 | 1000 | 750 | 90247 | 1250 |
| 0.56 | 6.0 \times 18.0 (21.0) \times 26.0 | 2.5 | 45564 | 1000 | 1000 | 650 | 90248 | 1000 |
| 0.68 | 6.6 \times 18.5 (21.5) \times 26.0 | 2.8 | 45684 | 1000 | 1000 | 600 | 90249 | 1000 |
| 0.82 | 7.2 \times 19.0 (22.0) \times 26.0 | 3.2 | 45824 | 1000 | 1000 | 550 | 90251 | 900 |
| 1 | 8.0 \times 20.0 (23.0) \times 26.0 | 3.8 | 45105 | 1000 | 500 | 500 | 90252 | 750 |



Metallized Polyester Film Capacitors Vishay BCcomponents
MKT Radial Epoxy Lacquered Type

| C (μ F) | DIMENSIONS $w_{max} \times h_{max} \times l_{max}$ (mm) | MASS (g) | CATALOG NUMBER 2222 368 AND PACKAGING | | | | | |
|---|---|-------------|---|------------------------------------|------------|------|-------------------------------|-----|
| | | | LOOSE IN BOX | | | REEL | LOOSE IN BOX | |
| | | | $l_t =$ 4.0 + 1.0/- 0.5 mm | short leads | long leads | SPQ | $l_t =$ 4.0 + 1.0/- 0.5 mm | SPQ |
| | | | C-tol = \pm 10 % | | | | C-tol = \pm 10 % | |
| last 5 digits of catalog number | SPQ | SPQ | SPQ | last 5 digits of catalog number | SPQ | | | |
| Pitch = 27.5 \pm 0.4 mm; $d_t = 0.80 \pm 0.08$ mm | | | | | | | lock lead | |
| 1.2 | 8.0 \times 21.0 (23.0) \times 30.0 | 4.1 | 45125 | 500 | 500 | | 90253 | 600 |
| 1.5 | 9.0 \times 22.0 (25.0) \times 30.0 | 4.8 | 45155 | 500 | 500 | | 90254 | 450 |
| 1.8 | 10.0 \times 23.0 (26.0) \times 30.0 | 5.5 | 45185 | 500 | 500 | | 90255 | 400 |
| 2.2 | 11.0 \times 24.0 (27.0) \times 30.0 | 6.2 | 45225 | 500 | 250 | | 90256 | 350 |

$U_{Rdc} = 400$ V; $U_{Rac} = 220$ V

| C (μ F) | DIMENSIONS $w_{max} \times h_{max} \times l_{max}$ (mm) | MASS (g) | CATALOG NUMBER 2222 368 AND PACKAGING | | | | | |
|---|---|-------------|---|------------------------------------|------------|------|-------------------------------|------|
| | | | LOOSE IN BOX | | | REEL | LOOSE IN BOX | |
| | | | $l_t =$ 4.0 + 1.0/- 0.5 mm | short leads | long leads | SPQ | $l_t =$ 4.0 + 1.0/- 0.5 mm | SPQ |
| | | | C-tol = \pm 10 % | | | | C-tol = \pm 10 % | |
| last 5 digits of catalog number | SPQ | SPQ | SPQ | last 5 digits of catalog number | SPQ | | | |
| Pitch = 10.0 \pm 0.4 mm; $d_t = 0.60 \pm 0.06$ mm | | | | | | | lock lead | |
| 0.001 | 4.5 \times 13.5 (15.5) \times 12.5 | 0.5 | 55102 | 2000 | 1000 | 1500 | 90257 | 1100 |
| 0.0012 | | | 55122 | | | | 90258 | |
| 0.0015 | | | 55152 | | | | 90259 | |
| 0.0018 | | | 55182 | | | | 90261 | |
| 0.0022 | 4.0 \times 13.0 (15.5) \times 12.5 | 0.5 | 55222 | 2000 | 1000 | 1500 | 90262 | 1100 |
| 0.0027 | 4.3 \times 13.3 (15.5) \times 12.5 | 0.5 | 55272 | 2000 | 1000 | 1500 | 90263 | 1100 |
| 0.0033 | 4.6 \times 13.6 (15.5) \times 12.5 | 0.5 | 55332 | 2000 | 1000 | 1500 | 90264 | 1100 |
| 0.0039 | 4.0 \times 13.0 (15.5) \times 12.5 | 0.5 | 55392 | 2000 | 1000 | 1500 | 90265 | 1100 |
| 0.0047 | 4.1 \times 13.2 (15.5) \times 12.5 | 0.5 | 55472 | 2000 | 1000 | 1500 | 90266 | 1100 |
| 0.0056 | 4.6 \times 13.6 (15.5) \times 12.5 | 0.5 | 55562 | 2000 | 1000 | 1500 | 90267 | 1100 |
| 0.0068 | | | 55682 | | | | 90268 | |
| 0.0082 | | | 55822 | | | | 90269 | |
| 0.01 | | | 55103 | | | | 90271 | |
| 0.012 | 4.0 \times 13.0 (15.5) \times 12.5 | 0.5 | 55123 | 2000 | 1000 | 1500 | 90272 | 1100 |
| 0.015 | 4.1 \times 13.0 (15.5) \times 12.5 | 0.5 | 55153 | 2000 | 1000 | 1300 | 90273 | 1100 |
| 0.018 | 4.4 \times 13.0 (15.5) \times 12.5 | 0.5 | 55183 | 2000 | 1000 | 1500 | 90274 | 1100 |
| 0.022 | 4.2 \times 12.9 (15.5) \times 12.5 | 0.5 | 55223 | 2000 | 1000 | 1500 | 90175 | 1100 |
| 0.027 | 4.2 \times 13.2 (15.5) \times 12.5 | 0.5 | 55273 | 2000 | 1000 | 1300 | 90275 | 1100 |
| 0.033 | 4.6 \times 13.7 (15.5) \times 12.5 | 0.5 | 55333 | 2000 | 1000 | 1300 | 90188 | 1100 |
| Pitch = 15.0 \pm 0.4 mm; $d_t = 0.80 \pm 0.08$ mm | | | | | | | lock lead | |
| 0.039 | 5.0 \times 13.9 (16.5) \times 17.5 | 0.6 | 55393 | 2000 | 1000 | 1200 | 90276 | 2000 |
| 0.047 | 5.4 \times 14.5 (17.0) \times 17.5 | 0.7 | 55473 | 2000 | 1000 | 1200 | 90277 | 1750 |
| 0.056 | 5.0 \times 13.7 (16.5) \times 17.5 | 0.6 | 55563 | 2000 | 1000 | 1200 | 90278 | 2000 |
| 0.068 | 5.0 \times 13.5 (16.5) \times 17.5 | 0.6 | 55683 | 2000 | 1000 | 1200 | 90279 | 2000 |
| 0.082 | 4.8 \times 14.0 (16.5) \times 17.5 | 0.6 | 55823 | 2000 | 1000 | 1100 | 90281 | 2000 |
| 0.1 | 5.3 \times 14.5 (17.5) \times 17.5 | 0.7 | 55104 | 2000 | 1000 | 1000 | 90186 | 1500 |
| 0.12 | 5.7 \times 15.0 (18.0) \times 17.5 | 0.9 | 55124 | 1000 | 1000 | 900 | 90282 | 1500 |
| 0.15 | 6.4 \times 15.5 (18.5) \times 17.5 | 1.0 | 55154 | 1000 | 1000 | 800 | 90187 | 1250 |



| C (μ F) | DIMENSIONS $W_{max} \times h_{max} \times l_{max}$ (mm) | MASS (g) | CATALOG NUMBER 2222 368 AND PACKAGING | | | | | |
|---|---|-------------|---|------------------------------------|------------|------|-------------------------------|------|
| | | | LOOSE IN BOX | | | REEL | LOOSE IN BOX | |
| | | | $l_t =$ 4.0 + 1.0/- 0.5 mm | short leads | long leads | SPQ | $l_t =$ 4.0 + 1.0/- 0.5 mm | SPQ |
| | | | C-tol = \pm 10 % | | | | C-tol = \pm 10 % | |
| last 5 digits of catalog number | SPQ | SPQ | SPQ | last 5 digits of catalog number | SPQ | | | |
| Pitch = 22.5 \pm 0.4 mm; d_t = 0.80 \pm 0.08 mm | | | | | | | lock lead | |
| 0.18 | 5.6 \times 17.5 (20.5) \times 26.0 | 2.2 | 55184 | 1000 | 1000 | 800 | 90283 | 1250 |
| 0.22 | 6.3 \times 18.5 (21.5) \times 26.0 | 2.8 | 55224 | 1000 | 1000 | 650 | 90284 | 1000 |
| 0.27 | 6.0 \times 18.0 (21.0) \times 26.0 | 2.5 | 55274 | 1000 | 1000 | 650 | 90285 | 1000 |
| 0.33 | 6.4 \times 18.5 (21.5) \times 26.0 | 2.8 | 55334 | 1000 | 1000 | 650 | 90286 | 1000 |
| 0.39 | 7.1 \times 19.0 (21.5) \times 26.0 | 2.8 | 55394 | 1000 | 1000 | 550 | 90287 | 900 |
| 0.47 | 8.0 \times 20.0 (22.5) \times 26.0 | 3.8 | 55474 | 1000 | 500 | 500 | 90179 | 750 |
| Pitch = 27.5 \pm 0.4 mm; d_t = 0.80 \pm 0.08 mm | | | | | | | lock lead | |
| 0.56 | 7.5 \times 20.5 (22.5) \times 30.0 | 3.8 | 55564 | 500 | 500 | | 90288 | 600 |
| 0.68 | 8.5 \times 21.5 (23.5) \times 30.0 | 4.5 | 55684 | 500 | 500 | | 90289 | 500 |
| 0.82 | 9.5 \times 22.5 (24.5) \times 30.0 | 5.2 | 55824 | 500 | 500 | | 90291 | 450 |
| 1 | 10.5 \times 23.5 (26.5) \times 30.0 | 5.8 | 55105 | 500 | 250 | | 90292 | 350 |

$U_{Rdc} = 630$ V; $U_{Rac} = 250$ V

| C (μ F) | DIMENSIONS $W_{max} \times h_{max} \times l_{max}$ (mm) | MASS (g) | CATALOG NUMBER 2222 368 AND PACKAGING | | | | | |
|---|---|-------------|---|------------------------------------|------------|------|-------------------------------|------|
| | | | LOOSE IN BOX | | | REEL | LOOSE IN BOX | |
| | | | $l_t =$ 4.0 + 1.0/- 0.5 mm | short leads | long leads | SPQ | $l_t =$ 4.0 + 1.0/- 0.5 mm | SPQ |
| | | | C-tol = \pm 10 % | | | | C-tol = \pm 10 % | |
| last 5 digits of catalog number | SPQ | SPQ | SPQ | last 5 digits of catalog number | SPQ | | | |
| Pitch = 10.0 \pm 0.4 mm; d_t = 0.60 \pm 0.06 mm | | | | | | | lock lead | |
| 0.01 | 4.3 \times 13.1 (15.5) \times 12.5 | 0.5 | 65103 | 2000 | 1000 | 1300 | 90293 | 1100 |
| 0.012 | 4.6 \times 13.4 (16.0) \times 12.5 | 0.5 | 65123 | 2000 | 1000 | 1200 | 90294 | 1000 |
| 0.015 | 4.9 \times 13.9 (16.5) \times 12.5 | 0.6 | 65153 | 2000 | 1000 | 1100 | 90295 | 1500 |
| 0.018 | 5.3 \times 14.3 (17.0) \times 12.5 | 0.6 | 65183 | 2000 | 1000 | 1000 | 90296 | 1250 |
| 0.022 | 5.9 \times 14.9 (17.5) \times 12.5 | 0.8 | 65223 | 2000 | 1000 | 900 | 90297 | 1250 |
| Pitch = 15.0 \pm 0.4 mm; d_t = 0.80 \pm 0.08 mm | | | | | | | lock lead | |
| 0.027 | 5.5 \times 14.5 (17.5) \times 17.5 | 0.7 | 65273 | 2000 | 1000 | 1100 | 90298 | 1500 |
| 0.033 | 6.0 \times 15.0 (18.0) \times 17.5 | 0.9 | 65333 | 2000 | 1000 | 1000 | 90299 | 1500 |
| 0.039 | 6.3 \times 15.5 (18.5) \times 17.5 | 1.0 | 65393 | 2000 | 1000 | 900 | 90301 | 1250 |
| 0.047 | 7.0 \times 16.0 (19.0) \times 17.5 | 1.2 | 65473 | 2000 | 1000 | 800 | 90302 | 1250 |
| 0.056 | 7.5 \times 16.5 (19.5) \times 17.5 | 1.3 | 65563 | 1000 | 1000 | 800 | 90303 | 1000 |
| 0.068 | 8.0 \times 17.0 (20.0) \times 17.5 | 1.4 | 65683 | 1000 | 1000 | 750 | 90304 | 1000 |
| Pitch = 22.5 \pm 0.4 mm; d_t = 0.80 \pm 0.08 mm | | | | | | | lock lead | |
| 0.082 | 6.1 \times 18.0 (21.0) \times 26.0 | 2.5 | 65823 | 1000 | 1000 | 750 | 90305 | 1000 |
| 0.1 | 7.0 \times 19.0 (22.0) \times 26.0 | 3.2 | 65104 | 1000 | 1000 | 650 | 90306 | 900 |
| 0.12 | 7.2 \times 19.5 (22.5) \times 26.0 | 3.5 | 65124 | 1000 | 1000 | 550 | 90307 | 750 |
| 0.15 | 8.0 \times 21.0 (23.0) \times 26.0 | 3.8 | 65154 | 1000 | 500 | 500 | 90308 | 750 |
| 0.18 | 9.0 \times 22.0 (24.0) \times 26.0 | 4.5 | 65184 | 1000 | 500 | 450 | 90309 | 600 |
| 0.22 | 10.0 \times 23.0 (25.0) \times 26.0 | 5.2 | 65224 | 1000 | 500 | 400 | 90311 | 550 |



| C (μ F) | DIMENSIONS $w_{max} \times h_{max} \times l_{max}$ (mm) | MASS (g) | CATALOG NUMBER 2222 368 AND PACKAGING | | | | | |
|--|---|-------------|---|-------------|------------|------|------------------------------------|-----|
| | | | LOOSE IN BOX | | | REEL | LOOSE IN BOX | |
| | | | $l_t =$ 4.0 + 1.0/- 0.5 mm | short leads | long leads | SPQ | $l_t =$ 4.0 + 1.0/- 0.5 mm | SPQ |
| | | | C-tol = $\pm 10\%$ | | | | C-tol = $\pm 10\%$ | |
| | | | last 5 digits of catalog number | SPQ | SPQ | SPQ | last 5 digits of catalog number | SPQ |
| Pitch = 27.5 \pm 0.4 mm; $d_t = 0.80 \pm 0.08$ mm | | | | | | | lock lead | |
| 0.27 | 10.0 \times 23.0 (25.0) \times 30.0 | 5.5 | 65274 | 500 | 500 | | 90312 | 400 |
| 0.33 | 11.5 \times 24.5 (26.5) \times 30.0 | 6.5 | 65334 | 500 | 250 | | 90313 | 350 |
| 0.39 | 12.5 \times 25.5 (28.5) \times 30.0 | 7.1 | 65394 | 500 | 250 | | 90314 | 300 |
| 0.47 | 14.0 \times 27.0 (30.0) \times 30.0 | 8.2 | 65474 | 250 | 250 | | 90315 | 250 |

CAPACITANCE

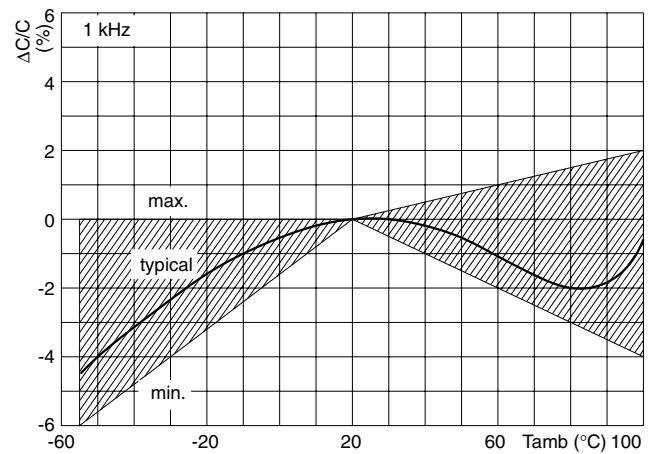
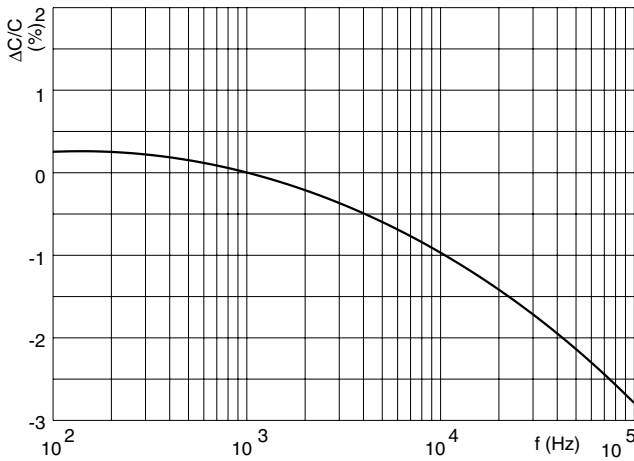

IMPEDANCE

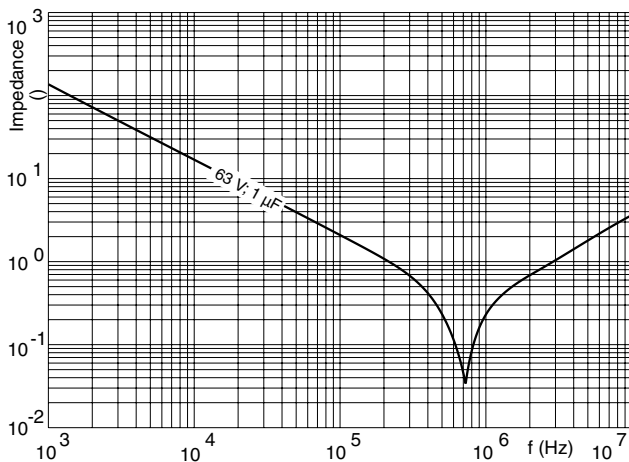

MAXIMUM RMS VOLTAGE (SINEWAVE) AS A FUNCTION OF FREQUENCY

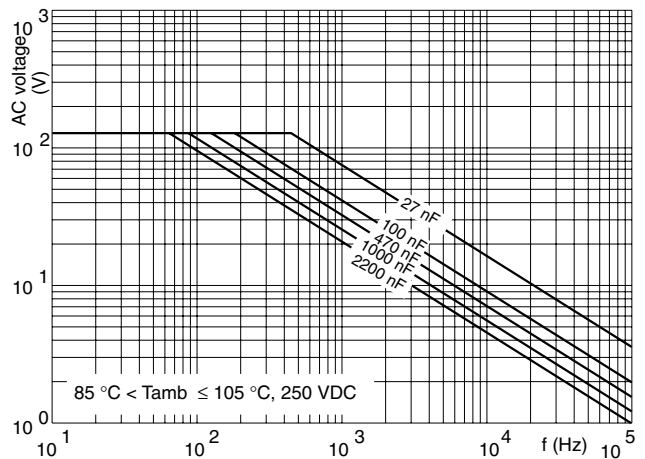
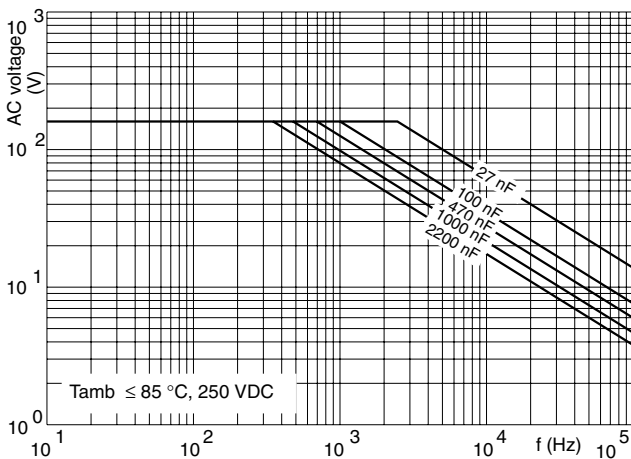
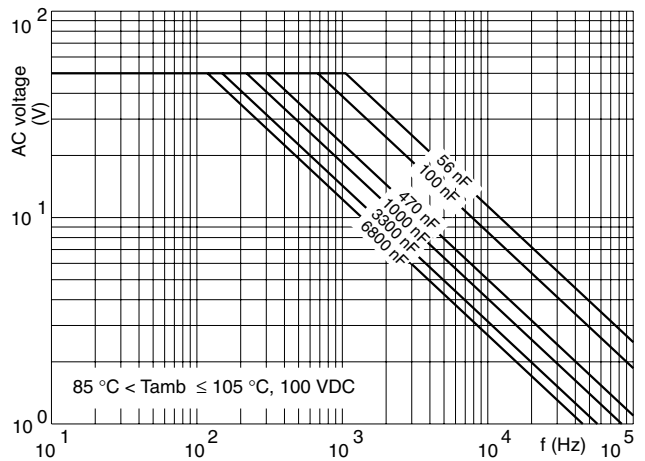
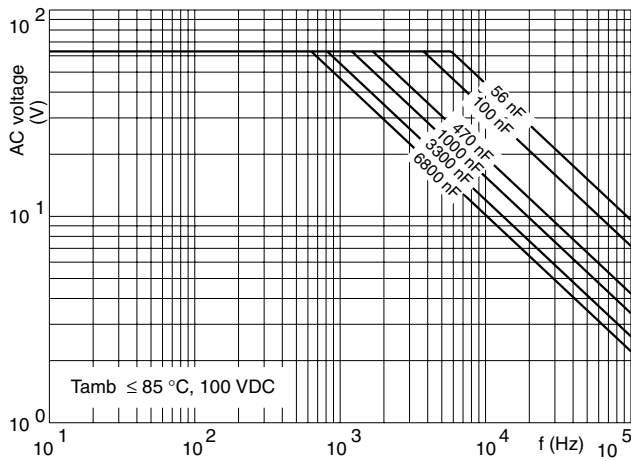
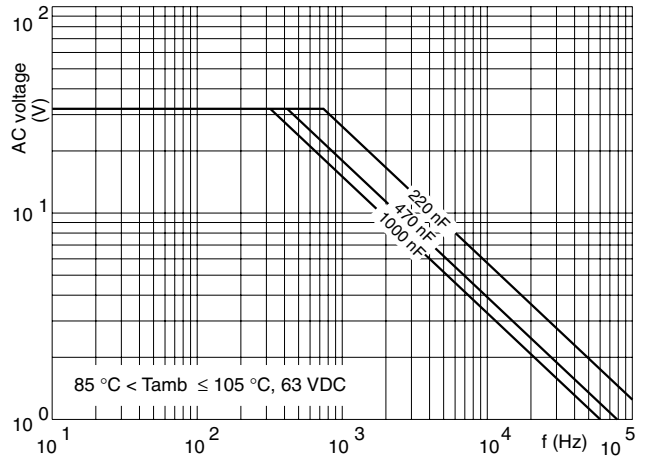
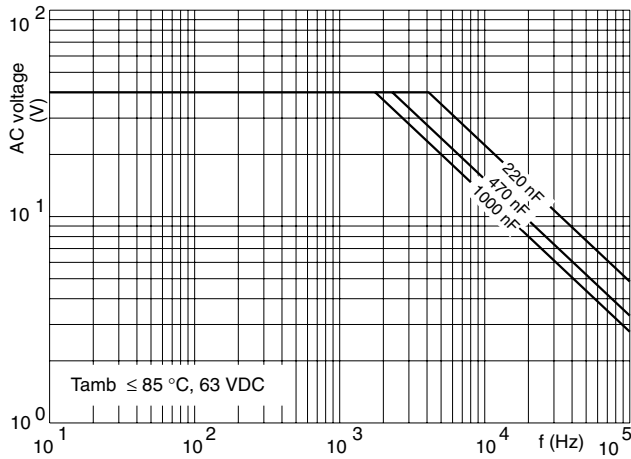

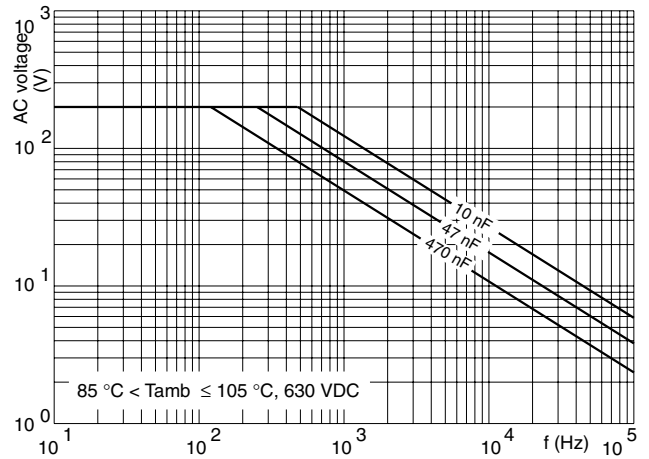
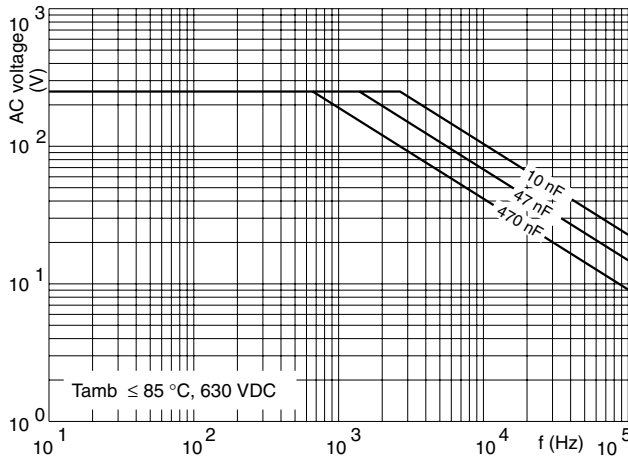
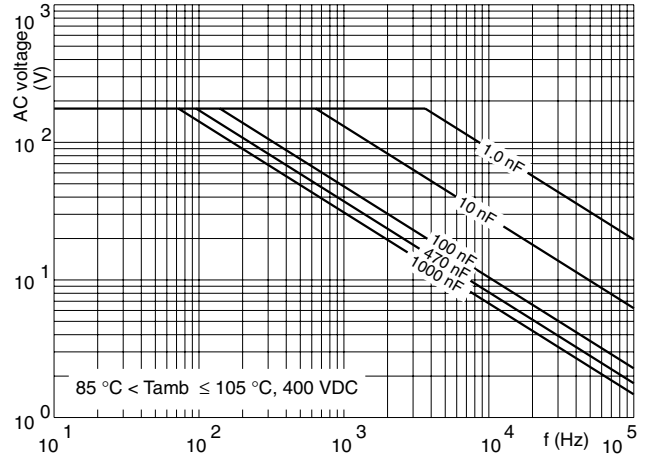
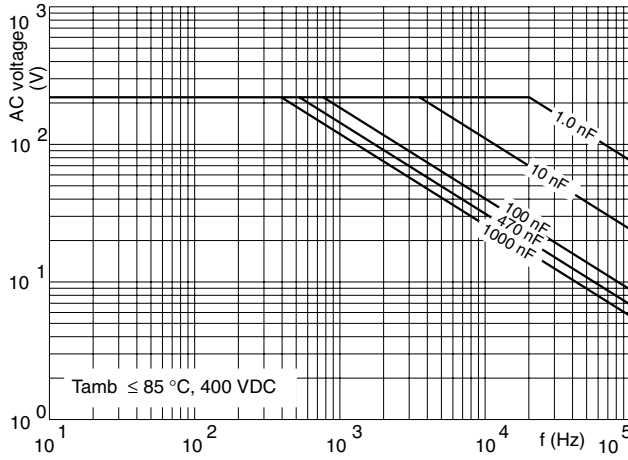



Disclaimer

All product specifications and data are subject to change without notice.

Vishay Intertechnology, Inc., its affiliates, agents, and employees, and all persons acting on its or their behalf (collectively, "Vishay"), disclaim any and all liability for any errors, inaccuracies or incompleteness contained herein or in any other disclosure relating to any product.

Vishay disclaims any and all liability arising out of the use or application of any product described herein or of any information provided herein to the maximum extent permitted by law. The product specifications do not expand or otherwise modify Vishay's terms and conditions of purchase, including but not limited to the warranty expressed therein, which apply to these products.

No license, express or implied, by estoppel or otherwise, to any intellectual property rights is granted by this document or by any conduct of Vishay.

The products shown herein are not designed for use in medical, life-saving, or life-sustaining applications unless otherwise expressly indicated. Customers using or selling Vishay products not expressly indicated for use in such applications do so entirely at their own risk and agree to fully indemnify Vishay for any damages arising or resulting from such use or sale. Please contact authorized Vishay personnel to obtain written terms and conditions regarding products designed for such applications.

Product names and markings noted herein may be trademarks of their respective owners.