

## Technical Data Sheet

### 0.5mm Height Chip LED with Full Color

#### 19-137B/RSGHBHC-C01/2T(RIM)

#### Features

- Package in 8mm tape on 7" diameter reel.
- Compatible with automatic placement equipment.
- Compatible with infrared and vapor phase reflow solder process.
- Full-color type.
- Pb-free.
- ESD protection
- The product itself will remain within RoHS compliant version.

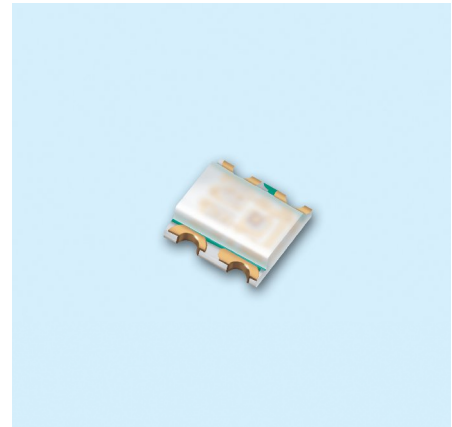

#### Descriptions

- The 19-137B SMD LED is much smaller than lead frame type components, thus enable smaller board size, higher packing density, reduced storage space and finally smaller equipment to be obtained.
- Besides, lightweight makes them ideal for miniature applications. etc.

#### Applications

- Backlighting in dashboard and switch.
- Telecommunication: indicator and backlighting in telephone and fax.
- Flat backlight for LCD, switch and symbol.
- General use.

#### Device Selection Guide

Chip			Resin Color
Type	Material	Emitted Color	
RS	AlGaInP	Brilliant Red	Water Clear
GH	InGaN	Brilliant Green	
BH	InGaN	Blue	

### Package Outline Dimensions

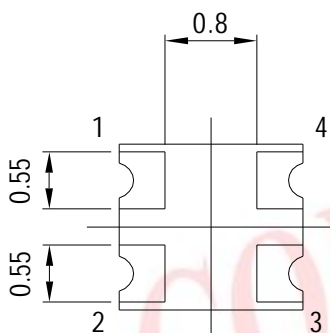
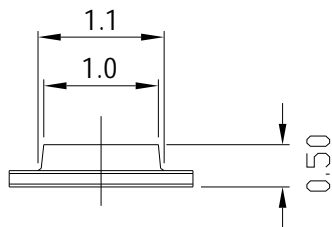
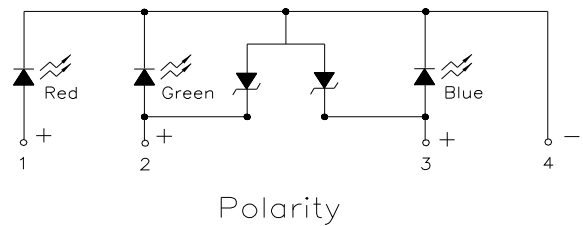
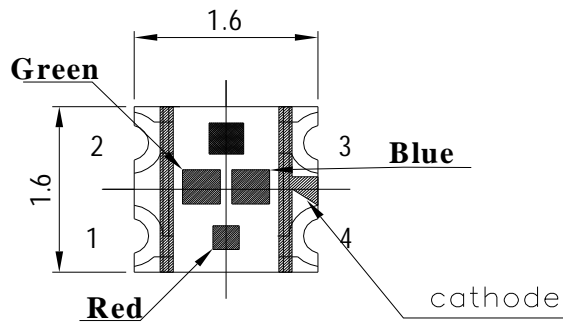

For reflow soldering (propose)

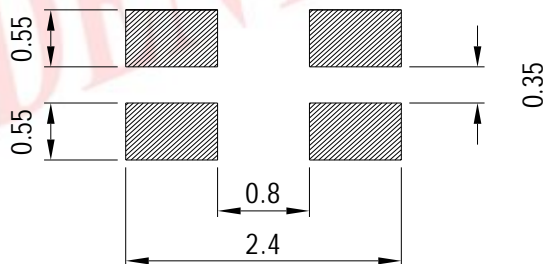

**Note:** The tolerance unless mentioned is  $\pm 0.1$  mm, unit is mm.

## 19-137B/RSGHBHC-C01/2T(RIM)

### Absolute Maximum Ratings (Ta=25 )

Parameter	Symbol	Rating	Unit
Reverse Voltage	V <sub>R</sub>	5	V
Forward Current	I <sub>F</sub>	RS:25 GH:25 BH:25	mA
Peak Forward Current (Duty 1/10 @1KHz)	I <sub>FP</sub>	RS:60 GH:100 BH:100	mA
Power Dissipation	P <sub>d</sub>	RS:60 GH:110 BH:110	mW
Electrostatic Discharge(HBM)	ESD	RS:2000 GH:2000 BH:2000	V
Operating Temperature	T <sub>opr</sub>	-40 ~ +85	
Storage Temperature	T <sub>stg</sub>	-40 ~ +90	
Soldering Temperature	T <sub>sol</sub>	Reflow Soldering : 260 Hand Soldering : 350	for 10 sec. for 3 sec.

### Electro-Optical Characteristics (Ta=25 )

Parameter	Symbol	Min.	Typ.	Max.	Unit	Condition
Luminous Intensity	RS	45		112	mcd	IF=5mA
	Iv GH	60	-----	110		
	BH	10		30		
Viewing Angle	2 1/2	-----	120	-----	deg	
Peak Wavelength	RS		632		nm	
	p GH	-----	518	-----		
	BH		468			
Dominant Wavelength	RS	617		627	nm	
	d GH	525	-----	540		
	BH	465		475		
Spectrum Radiation Bandwidth	RS		20			
	GH	-----	35	-----		
	BH		35			
Forward Voltage	RS	1.7		2.1	V	
	Vf GH	2.5	-----	3.1		
	BH	2.5		3.1		
Reverse Current	RS			10	μA	VR=5V
	IR GH	-----	-----	NA		
	BH			NA		

#### Notes:

- 1.Tolerance of Luminous Intensity  $\pm 11\%$
- 2.Tolerance of Dominant Wavelength  $\pm 1\text{nm}$
- 3.Tolerance of Forward Voltage  $\pm 0.05\text{V}$

### RS

#### Bin Range Of Luminous Intensity

Bin	Min	Max	Unit	Condition
P	45	72	mcd	If=5mA
Q	72	112		

### GH

#### Bin Range Of Luminous Intensity

Bin	Min	Max	Unit	Condition
1	60	85	mcd	If=5mA
2	85	110		

#### Bin Range Of Dom. Wavelength

Bin	Min	Max	Unit	Condition
1	525.0	532.5	nm	If=5mA
2	532.5	540.0		

### BH

#### Bin Range Of Dom. Wavelength

Bin	Min	Max	Unit	Condition
1	465	470	nm	If=5mA
2	470	475		

#### Notes:

- 1.Tolerance of Luminous Intensity  $\pm 11\%$
- 2.Tolerance of Dominant Wavelength  $\pm 1\text{nm}$

### Typical Electro-Optical Characteristics Curves

RS

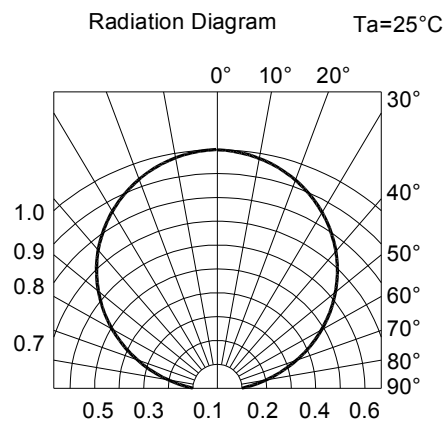
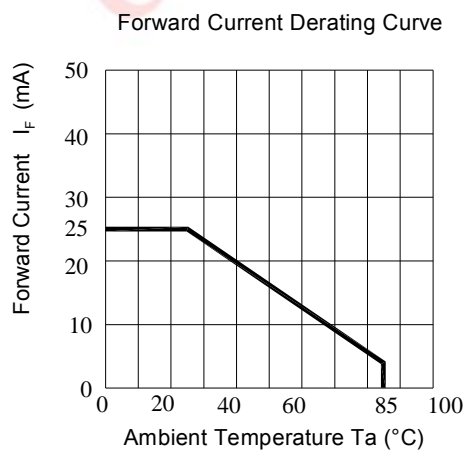
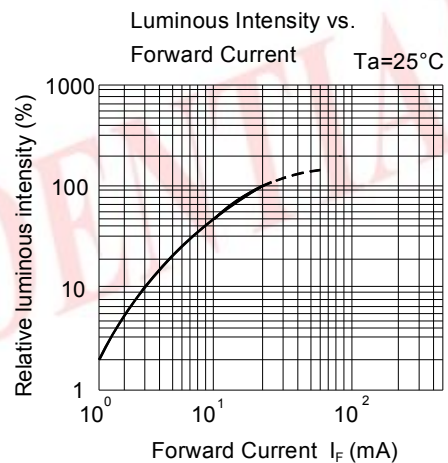
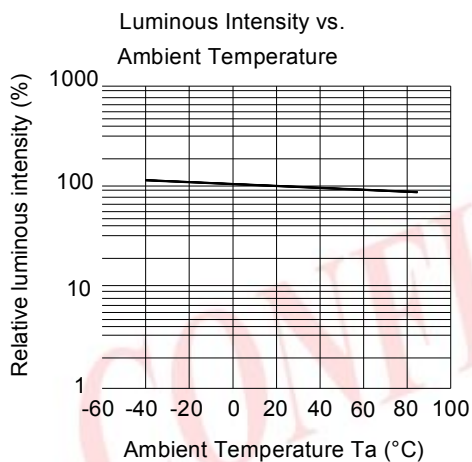
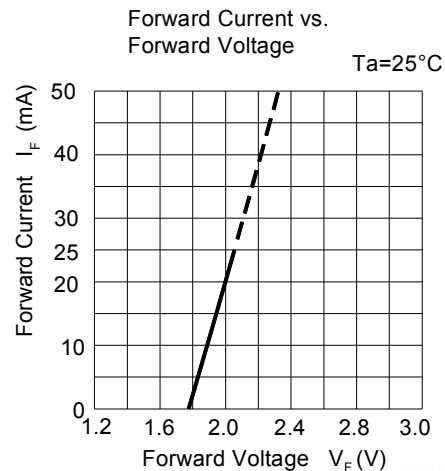
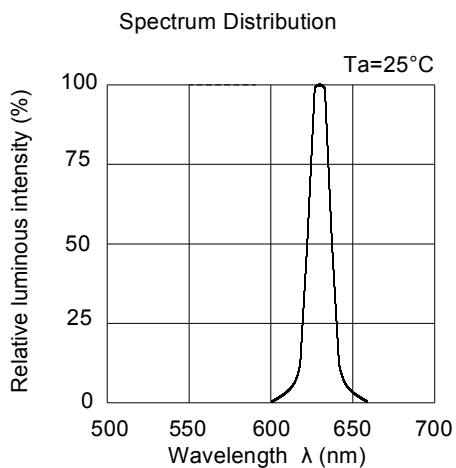

### Typical Electro-Optical Characteristics Curves

GH

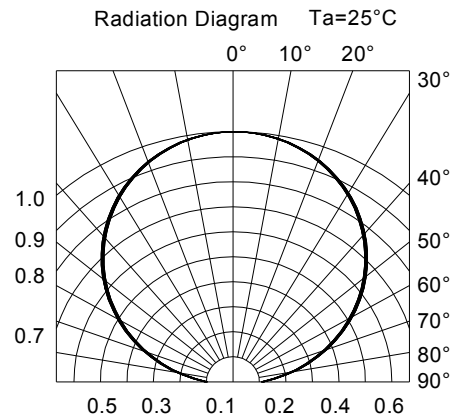
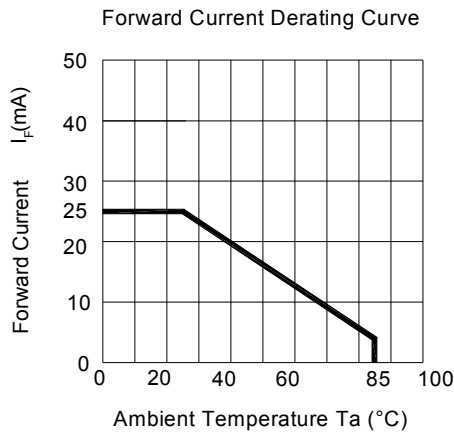
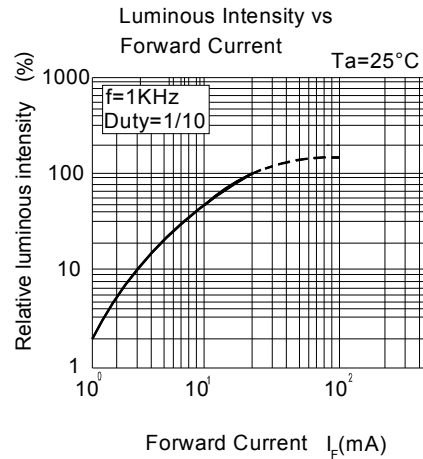
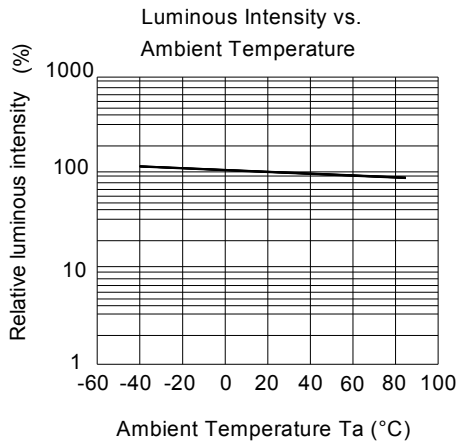
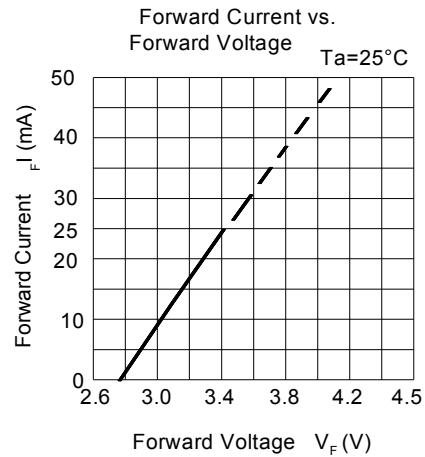
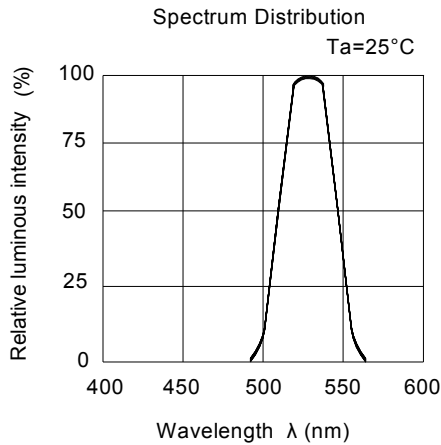

### Typical Electro-Optical Characteristics Curves

BH

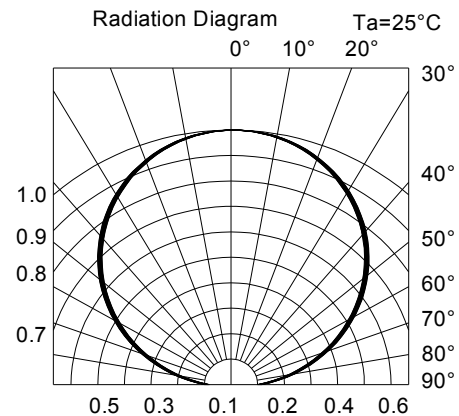
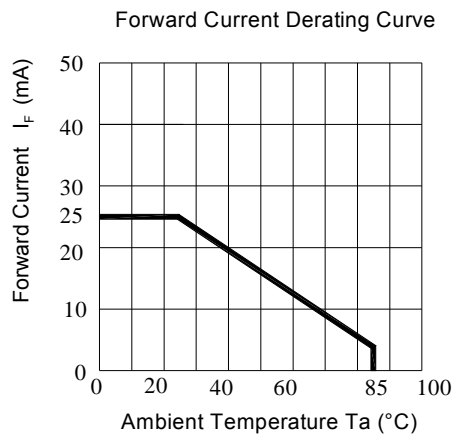
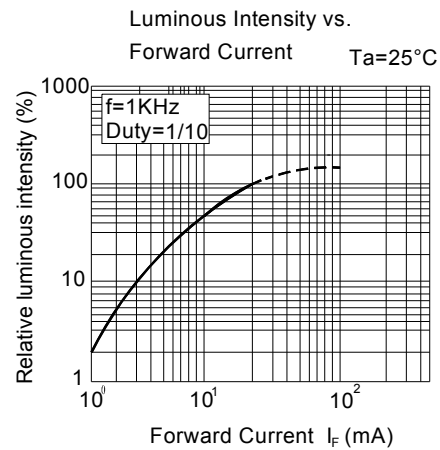
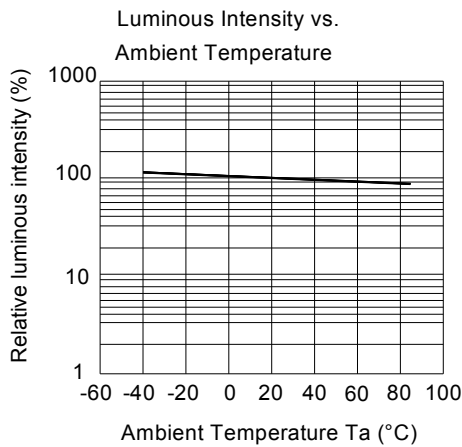
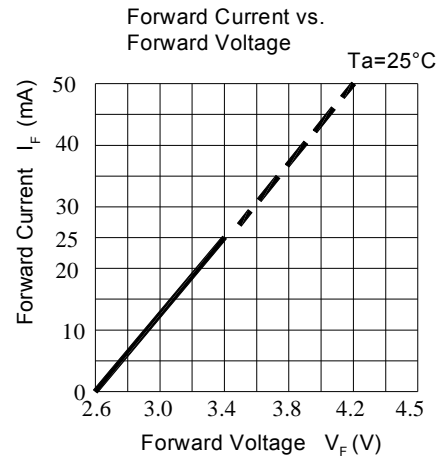
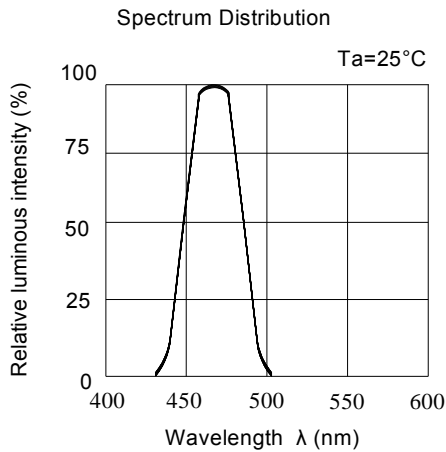



## 19-137B/RSGHBHC-C01/2T(RIM)

### Label Explanation

**CAT: Luminous Intensity Rank**

**HUE: Dom. Wavelength Rank**

**REF: Forward Voltage Rank**

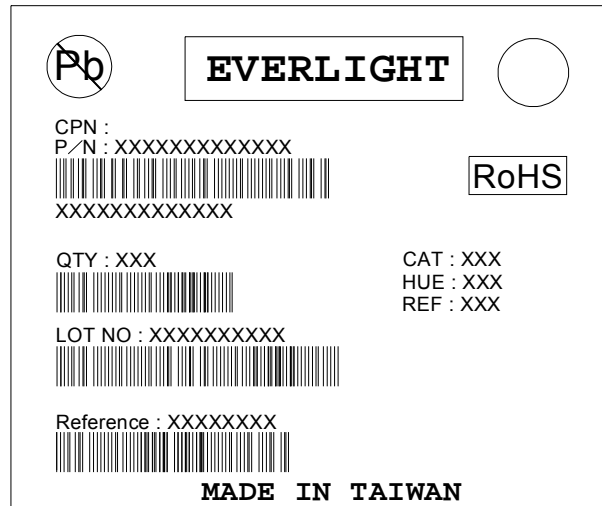

### Reel Dimensions

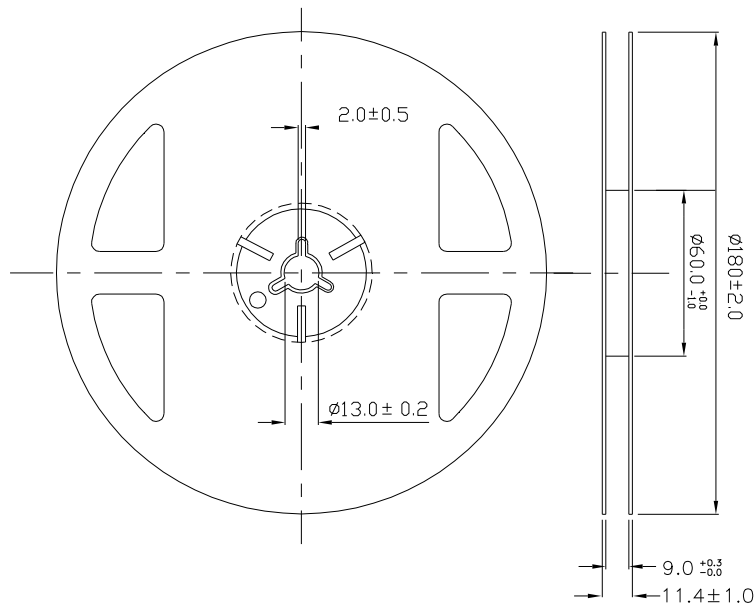

**Note:** The tolerances unless mentioned is  $\pm 0.1$ mm ,Unit = mm

**Carrier Tape Dimensions: Loaded quantity 2000 PCS per reel**

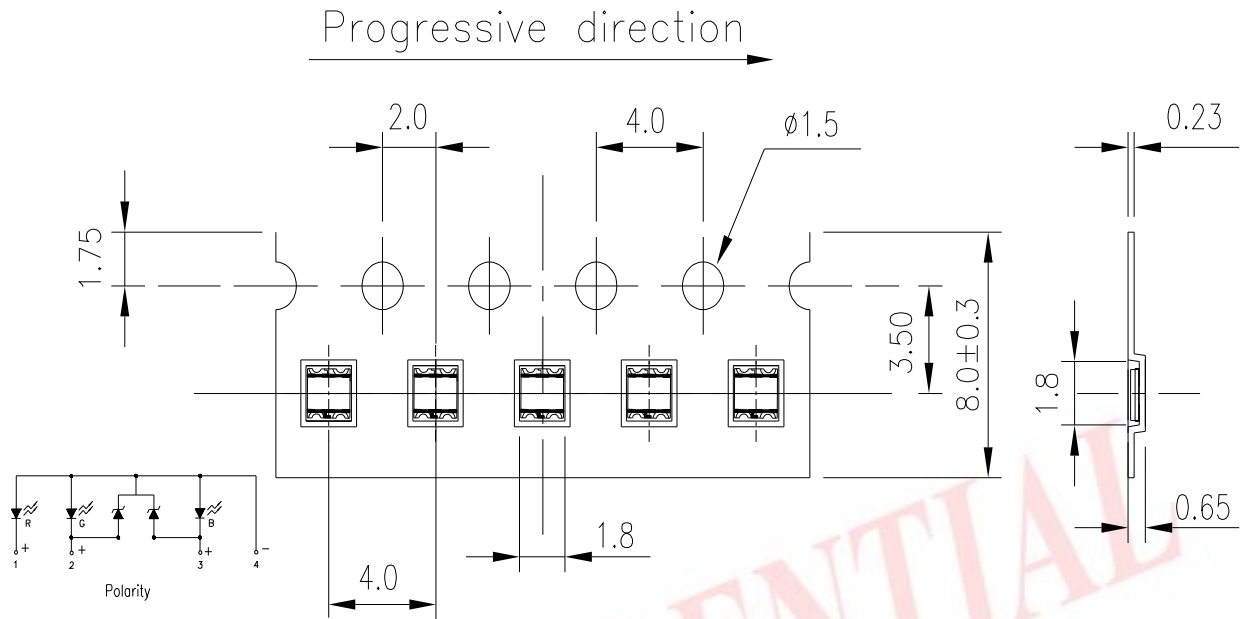

**Note:** The tolerance unless mentioned is  $\pm 0.1\text{mm}$ , unit is mm.

**Moisture Resistant Packaging**

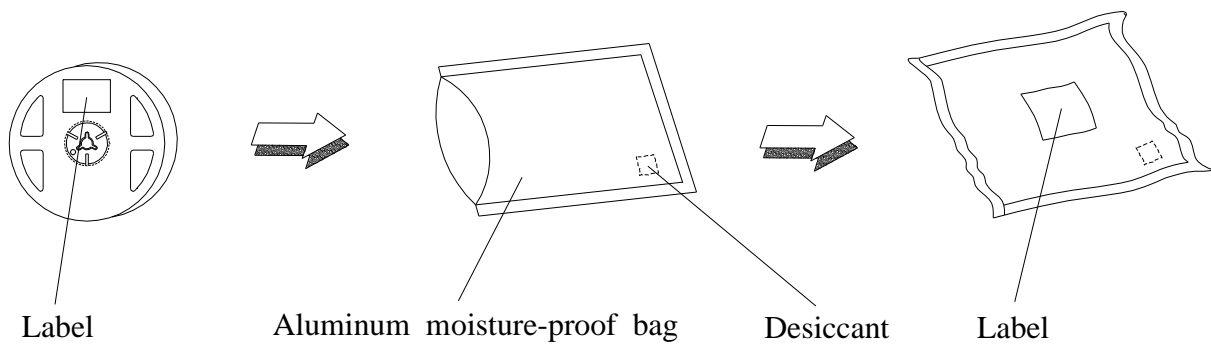

## 19-137B/RSGHBHC-C01/2T(RIM)

### Reliability Test Items And Conditions

The reliability of products shall be satisfied with items listed below.

Confidence level : 90%

LTPD : 10%

No.	Items	Test Condition	Test Hours/Cycles	Sample Size	Ac/Re
1	Reflow Soldering	Temp. : 260 ±5 Max. 10sec.	6 Min.	22 PCS.	0/1
2	Temperature Cycle	H : +100 15min 5 min L : -40 15min	300 Cycles	22 PCS.	0/1
3	Thermal Shock	H : +100 5min 10 sec L : -10 5min	300 Cycles	22 PCS.	0/1
4	High Temperature Storage	Temp. : 100	1000 Hrs.	22 PCS.	0/1
5	Low Temperature Storage	Temp. : -40	1000 Hrs.	22 PCS.	0/1
6	DC Operating Life	IF = 20 mA	1000 Hrs.	22 PCS.	0/1
7	High Temperature / High Humidity	85 / 85%RH	1000 Hrs.	22 PCS.	0/1

### Precautions For Use

#### 1. Over-current-proof

Customer must apply resistors for protection, otherwise slight voltage shift will cause big current change ( Burn out will happen ).

#### 2. Storage

2.1 Do not open moisture proof bag before the products are ready to use.

2.2 Before opening the package: The LEDs should be kept at 30 or less and 90%RH or less.

2.3 After opening the package: The LED's floor life is 1 year under 30 or less and 60% RH or less.

If unused LEDs remain, it should be stored in moisture proof packages.

2.4 If the moisture absorbent material (silica gel) has faded away or the LEDs have exceeded the storage time, baking treatment should be performed using the following conditions.

Baking treatment :  $60 \pm 5$  for 24 hours.

#### 3. Soldering Condition

##### 3.1 Pb-free solder temperature profile

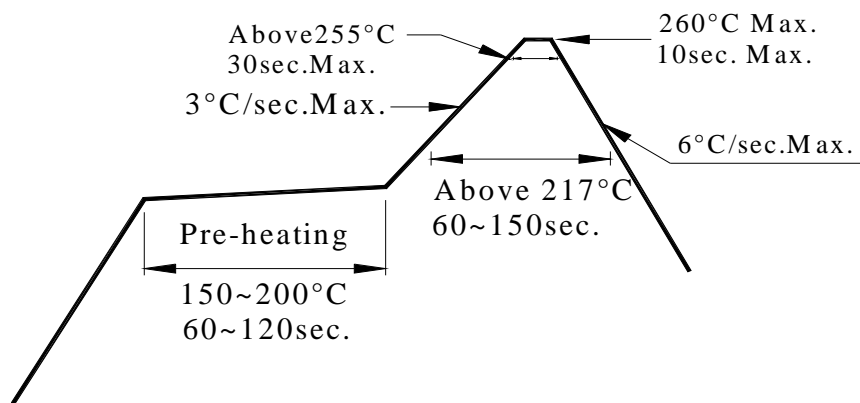

3.2 Reflow soldering should not be done more than two times.

3.3 When soldering, do not put stress on the LEDs during heating.

3.4 After soldering, do not warp the circuit board.

### 4.Soldering Iron

Each terminal is to go to the tip of soldering iron temperature less than 350 for 3 seconds within once in less than the soldering iron capacity 25W. Leave two seconds and more intervals, and do soldering of each terminal. Be careful because the damage of the product is often started at the time of the hand solder.

### 5.Repairing

Repair should not be done after the LEDs have been soldered. When repairing is unavoidable, a double-head soldering iron should be used (as below figure). It should be confirmed beforehand whether the characteristics of the LEDs will or will not be damaged by repairing.

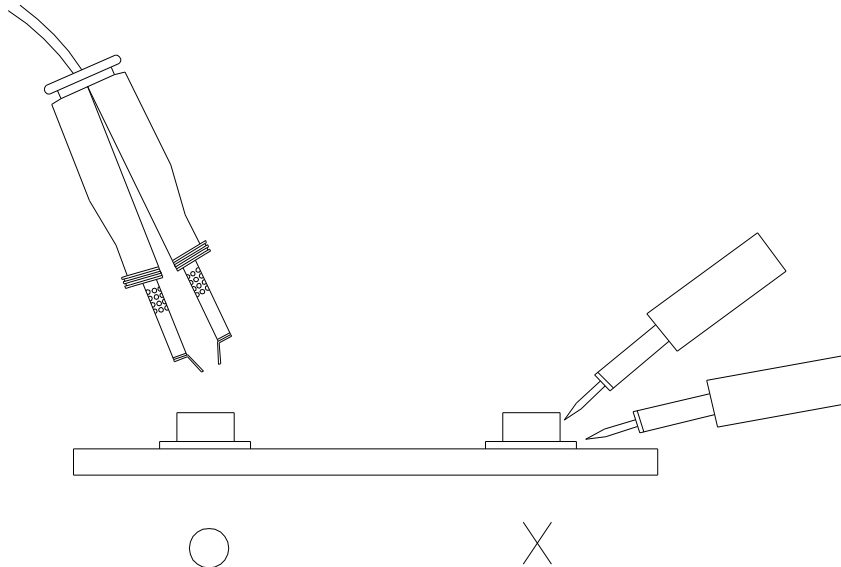

**EVERLIGHT ELECTRONICS CO., LTD.**  
Office: No 25, Lane 76, Sec 3, Chung Yang Rd,  
Tucheng, Taipei 236, Taiwan, R.O.C

Tel: 886-2-2267-2000, 2267-9936  
Fax: 886-2267-6244, 2267-6189, 2267-6306  
<http://www.everlight.com>